

Hydrophobic Interaction Chromatography

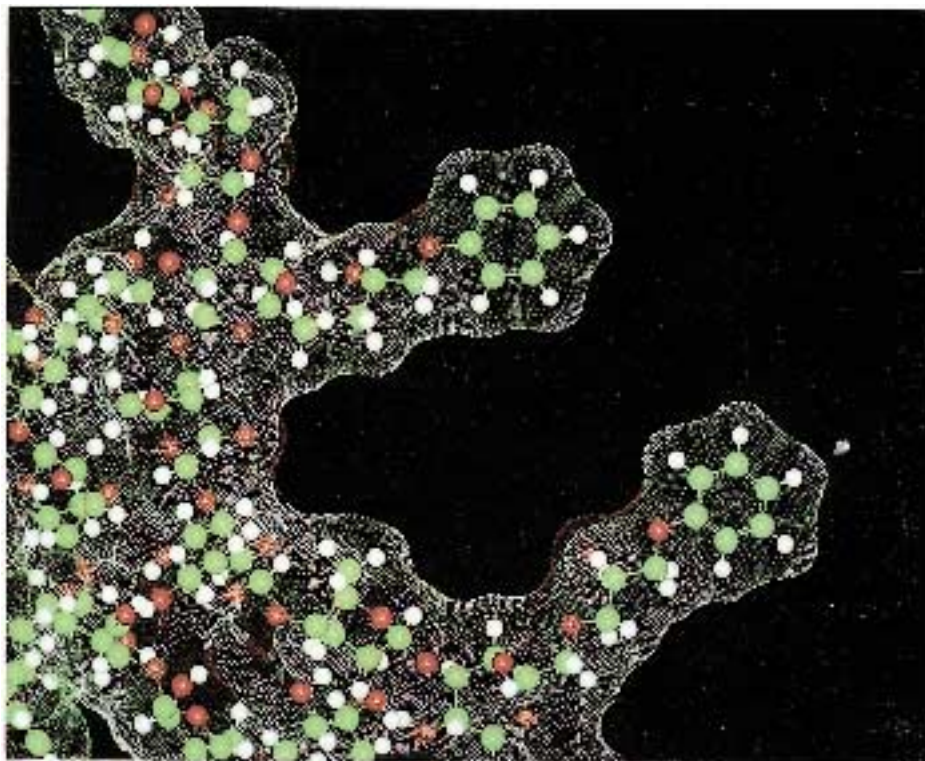

PRINCIPLES AND METHODS

18-1020-90

Edition AB



amersham pharmacia biotech

to order:

Asia Pacific Tel: +852 2811 8693 Fax: +852 2811 5251 **Australasia** Tel: +61 2 9894 5152 Fax: +61 2 9899 7511 **Austria** Tel: 01 576 0616 20 Fax: 01 576 0616 2
Belgium Tel: 0800 73 888 Fax: 03 272 1637 **Canada** Tel: 1 800 463 5800 Fax: 1 800 567 1008 **Central, East, South East Europe** Tel: +43 1 982 3826 Fax: +43 1 985 8327 **Denmark** Tel: 45 16 2400 Fax: 45 16 2424 **Finland** Tel: 09 512 3940 Fax: 09 512 1710 **France** Tel: 0169 35 67 00 Fax: 0169 41 9677 **Germany** Tel: 0761 4903
Fax: 0761 4903 405 **Italy** Tel: 02 27322 1 Fax: 02 27302 212 **Japan** Tel: 81 3 5331 9336 Fax: 81 3 5331 9370 **Latin America** Tel: +55 11 3667 5700 Fax: +55 11 3667 87 99 **Middle East and Africa** Tel: +30 (1) 96 00 687 Fax: +30 (1) 96 00 693 **Netherlands** Tel: 0165 580 410 Fax: 0165 580 401 **Norway** Tel: 2318 5800
Fax: 2318 6800
Portugal Tel: 01 417 7035 Fax: 01 417 3184 **Russian Federation** Tel: +7 (095) 232 0250,956 1137 Fax: +7 (095) 230 6377 **South East Asia** Tel: 60 3 724 2080
Fax: 60 3 724 2090 **Spain** Tel: 93 594 49 50 Fax: 93 594 49 55 **Sweden** Tel: 018 612 19 00 Fax: 018 612 19 10 **Switzerland** Tel: 01 802 81 50 Fax: 01 802 81 5
UK Tel: 0800 616 928 Fax: 0800 616 927 **USA** Tel: +1 800 526 3593 Fax: +1 877 295 8102

Sephadex, Sepharose, Superose, BioProcess, FPLC, SMART, Mono Q, SOURCE, HiTrap, HiLoad, BPG, Superloop, Superdex, Ultrosan, PhastSystem, and RESOURCE are trademarks of Amersham Pharmacia Biotech Limited or its subsidiaries. Amersham is a trademark of Nycomed Amersham plc. Pharmacia and Drop Design are trademarks of Pharmacia & Upjohn. **Amersham Pharmacia Biotech AB** Björkgatan 30, SE-751 84 Uppsala, Sweden. **Amersham Pharmacia Biotech UK Limited** Amersham Place, Little Chalfont, Buckinghamshire HP7 9NA, England. **Amersham Pharmacia Biotech Inc** 800 Centennial Avenue, PO Box 1327, Piscataway, NJ 08855 USA. **Amersham Pharmacia Biotech Europe GmbH** Munzinger Strasse 9, D-79111 Freiburg, Germany. **Amersham Pharmacia Biotech K.K.** Sanken Building, 3-25-1, Hyakunincho, Shinjuku-ku, Tokyo 169-0073, Japan. All goods and services are sold subject to the terms and conditions of sale of the company within the Amersham Pharmacia Biotech group that supplies them. A copy of these terms and conditions is available on request. © Amersham Pharmacia Biotech AB 2000 – All rights reserved.

Hydrophobic Interaction Chromatography

PRINCIPLES AND METHODS



amersham pharmacia biotech

Foreword

Many biotechnologists began their careers in chromatography reading *Gel Filtration: Theory and Practice*. First published in 1966, this monograph has had over 250,000 copies printed in five languages. It was soon followed by another helpful monograph from Amersham Pharmacia Biotech on ion exchange. About 15 years ago, *Affinity Chromatography: Principles and Methods* was published describing the emergence of this powerful separating method for macromolecules. In some ways this monograph series has defined the critical methods in the field at the time of publication and has been both good business and a public service for over 25 years.

With the rise of the modern biotechnology industry and its requirement for highly purified pharmaceutical proteins, a further emphasis has been placed on entire processes with respect to their economy, capacity and resultant product quality. Often the extent of separation power required is defined by the need to resolve the product not only from the background impurities derived from the fermentation but also from degradation products and analogues of the drug itself. For many cases, hydrophobic interaction chromatography (HIC) is an ideal separation method.

In my experience, HIC is finding dramatically increased use both in laboratory and production processes. Since the molecular mechanism of HIC relies on unique structural features, it serves as an orthogonal method to ion exchange, gel filtration and affinity chromatography. It is very generic, yet capable of powerful resolution. Usually media have high capacity and are economical and stable. Adsorption takes place in high salt and desorption in low salt concentrations. These special properties make HIC very useful in whole processes for bridging or transitioning between other steps in addition to the separation which is effected.

This book can serve as an excellent introduction to the subject of HIC for those new to this method of separation. More experienced chromatographers can also benefit from the useful review. Topics include the molecular mechanism of separation by HIC in contrast to reversed phase chromatography, a helpful section on strategies for rapid method development, as well as a wide selection of examples. Practical aspects such as packing, use and sanitization of columns are discussed. There are many tricks, techniques and insights to be gained in a complete reading.

I recommend it be read and kept handy on your personal book shelf and I predict that you will find HIC a surprisingly helpful technique both alone and especially in combination with other modes of separation.

Stuart E. Builder
So. San Francisco
January 15, 1993

Contents

1. Introduction to HIC	9
2. Principles of HIC	11
Theory	11
HIC vs RPC	12
Factors affecting HIC	13
Type of ligand	13
Degree of substitution	14
Type of base matrix	14
Type and concentration of salt	15
Effect of pH	16
Effect of temperature	17
Additives	18
3. Product Guide	19
BioProcess Media	20
Base matrices	20
Coupling	21
Chemical stability	21
Physical stability	22
Binding capacity	22
Phenyl Sepharose 6 Fast Flow (low sub) and Phenyl Sepharose 6 Fast Flow (high sub)	23
Butyl Sepharose 4 Fast Flow	24
Phenyl Sepharose High Performance	25
Custom Designed HIC Media	26
HIC Media Test Kit	26

Contents

Phenyl Sepharose CL-4B and Octyl Sepharose CL-4B	27
Phenyl Superose and Alkyl Superose	27
4. Experimental Design	29
Hydrophobicity of proteins	29
Multivariate mapping	29
Strategic considerations	30
Choice of HIC media	31
General considerations	31
Screening experiments	32
Optimizing a HIC step	39
The solute	39
The solvent	41
Elution	42
Sample load and flow rate	45
Regeneration	45
Process considerations	46
Method optimization in process	
chromatography	46
Scaleability	49
Regulatory considerations	50
5. Experimental Technique	53
Choice of column	53
Column dimensions	53
Packing the column	53
Packing Sepharose Fast Flow based HIC gels	54
Packing Phenyl Sepharose High Performance	55
Packing Sepharose CL-4B based HIC gels	55

Contents

Use of an adaptor	55
Checking the packed bed	56
Prepacked HIC media	58
Sample preparation	59
Sample composition	59
Sample volume	59
Sample viscosity	60
Particle content	60
Sample application	61
Sample reservoir	61
Sample applicators	61
Sample loops with valves LV-4 or SRV-4	62
Sample loops or Superloop with valves V-7 or MV-7	62
Batch separation	63
Cleaning, sanitization and sterilization procedures	63
Storage of gels and columns	65
Prevention of microbial growth	65
Antimicrobial agents	65
Storage of unused media	67
Storage of used media	67
Storage of packed columns	67
Process considerations	68
Selecting a column	68
Aspects of column design	69
Packing large scale columns	71
Scale-up	74

Contents

6. Applications	77
Preparative and analytical HIC applications in the research laboratory	77
HIC in combination with ammonium sulphate precipitation	77
HIC in combination with ion exchange chromatography	78
HIC in combination with gel filtration	80
HIC as a "single step" purification technique	81
Analysis of conformational changes with HIC	84
Other HIC application areas in the research laboratory	84
Preparative, large scale applications	85
Purification of a monoclonal antibody for clinical studies of passive immunotherapy of HIV-1	85
Purification of recombinant human Epidermal Growth Factor (h-EGF) from yeast	87
Purification of a monoclonal antibody for in vitro diagnostic use	90
Purification of a recombinant Pseudomonas aeruginosa exotoxin, produced in E. Coli	92
7. References	97
Order from	102

Introduction to HIC

In a classical paper published in 1948 and entitled: “Adsorption Separation by Salting Out”, Tiselius [1] laid down the foundation for a separation method which is now popularly known as hydrophobic interaction chromatography (HIC). He noted that, “...proteins and other substances which are precipitated at high concentrations of neutral salts (salting out), often are adsorbed quite strongly already in salt solutions of lower concentration than is required for their precipitation, and that some adsorbents which in salt-free solutions show no or only slight affinity for proteins, at moderately high salt concentrations become excellent adsorbents”. Since then, great strides have been made in developing almost ideal stationary phases for chromatography (such as cellulose, cross-linked dextran (Sephadex™), cross-linked agarose (Sephacrose™ CL, Sepharose High Performance and Sepharose Fast Flow), and in developing coupling methods for immobilizing ligands of choice [2,3] to such matrices. It was a combination of these two events which, in the beginning of 1970's, led to the synthesis of a variety of hydrophobic adsorbents for biopolymer separations based on this previously rarely exploited principle.

The first attempt at synthesizing such adsorbents was made by Yon [4] followed by Er-el *et al.* [5], Hofstee [6] and Shaltiel & Er-el [7]. Characteristically, these early adsorbents showed a mixed ionic-hydrophobic character [8]. Despite this, Halperin *et al.* [9] claimed that protein binding to such adsorbents was predominantly of a hydrophobic character. Porath *et al.* [10] and Hjertén *et al.* [11] later synthesized charge-free hydrophobic adsorbents and demonstrated that the binding of proteins was enhanced by high concentrations of neutral salts, as previously observed by Tiselius [1], and that elution of the bound proteins was achieved simply by washing the column with salt-free buffer or by decreasing the polarity of the eluent [6, 10, 11]. Amersham Pharmacia Biotech was first in producing commercial HIC adsorbents (Phenyl and Octyl Sepharose CL-4B [12]) of the charge-free type and has continuously followed this up with new developments in agarose matrix design by introducing new stable HIC media based on Superose™, Sepharose Fast Flow and Sepharose High Performance, meeting various demands on chromatographic productivity, selectivity and efficiency.

The commercial availability of well-characterized HIC adsorbents opened new possibilities for purifying a variety of biomolecules such as serum proteins [12, 13], membrane-bound proteins [14], nuclear proteins [15], receptors [16], cells [17], and recombinant proteins [18, 19] in research and industrial laboratories. These adsorbents were also used for the reversible immobilization of enzymes [20] and liposomes [21].

The principle for protein adsorption to HIC media is complementary to ion exchange chromatography and gel filtration. HIC is even sensitive enough to be influenced by non-polar groups normally buried within the tertiary structure of proteins but exposed if the polypeptide chain is incorrectly folded or damaged (e.g. by proteases). This sensitivity can be useful for separating the pure native protein from other forms.

Altogether this makes HIC a versatile liquid chromatography technique, being a logical part of any rational purification strategy, often in combination with ion exchange chromatography and gel filtration. HIC has also found use as an analytical tool to detect protein conformational changes.

HIC requires a minimum of sample pre-treatment and can thus be used effectively in combination with traditional protein precipitation techniques.

Protein binding to HIC adsorbents is promoted by moderately high concentrations of anti-chaotropic salts, which also have a stabilizing influence on protein structure. Elution is achieved by a linear or stepwise decrease in the concentration of salt in the adsorption buffer. Recoveries are often very satisfactory.

A number of mechanisms have been proposed for HIC over the years and factors that affect the binding of proteins to such adsorbents have been investigated. These aspects will be briefly outlined in this handbook. Greater emphasis has been given to practical considerations on how to make optimal use of Amersham Pharmacia Biotech range of HIC products.

Principles of HIC

Theory

The discussions that follow in this chapter will be limited to the non-charged type of HIC adsorbents.

The many theories that have been proposed for HIC are essentially based upon those derived for interactions between hydrophobic solutes and water (22,23), but none of them has enjoyed universal acceptance. What is common to all is the central role played by the structure-forming salts and the effects they exert on the individual components (i.e., solute, solvent and adsorbent) of the chromatographic system to bring about the binding of solute to adsorbent. In view of this, Porath (24) proposed “salt-promoted adsorption” as a general concept for HIC and other types of solute-adsorbent interactions occurring in the presence of moderately high concentrations of neutral salts.

Hofstee (6) and later Shaltiel (7) proposed “hydrophobic chromatography” with the implicit assumption that the mode of interaction between proteins and the immobilized hydrophobic ligands is similar to the self association of small aliphatic organic molecules in water. Porath *et al.* (10) suggested a salting-out effect in hydrophobic adsorption, thus extending the earlier observations of Tiselius (1). They also suggested that “. . .the driving force is the entropy gain arising from structure changes in the water surrounding the interacting hydrophobic groups”. This concept was later extended and formalized by Hjertén (25) who based his theory on the well known thermodynamic relationship: $\Delta G = \Delta H - T\Delta S$. He proposed that the displacement of the ordered water molecules surrounding the hydrophobic ligands and the proteins leads to an increase in entropy (ΔS) resulting in a negative value for the change in free energy (ΔG) of the system. This implies that the hydrophobic ligand-protein interaction is thermodynamically favourable, as is illustrated in Fig. 1.

An alternative theory is based on the parallelism between the effect of neutral salts in salting out (precipitation) and HIC (26,27). According to Melander and Horvath (27), hydrophobic interaction is accounted for by increase in the surface tension of water arising from the structure – forming salts dissolved in it. In fact, a combination of these two mechanisms seems to be an obvious extension and has been exploited long

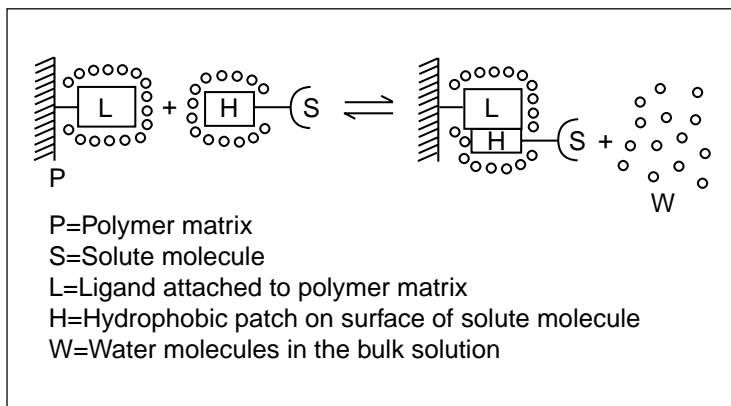

Fig. 1. Close to the surface of the hydrophobic ligand and solute (L and H), the water molecules are more highly ordered than in the bulk water and appear to “shield off” the hydrophobic ligand and solute molecules. Added salt interacts strongly with the water molecules leaving less water available for the “shielding off” effect, which is the driving force for L and H to interact with each other.

before HIC adsorbents were synthesized (28). Finally, Srinivasan and Ruckenstein (29) have proposed that HIC is due to van der Waals attraction forces between proteins and immobilized ligands. The basis for this theory is that the van der Waals attraction forces between protein and ligand increase as the ordered structure of water increases in the presence of salting out salts.

HIC vs RPC

In theory, HIC and reverse-phase chromatography (RPC) are closely related LC techniques. Both are based upon interactions between solvent-accessible non-polar groups (hydrophobic patches) on the surface of biomolecules and the hydrophobic ligands (alkyl or aryl groups) covalently attached to the gel matrix. In practice, however, they are different. Adsorbents for RPC are more highly substituted with hydrophobic ligands than HIC adsorbents. The degree of substitution of HIC adsorbents is usually in the range of 10–50 $\mu\text{moles/ml}$ gel of C_2 – C_8 alkyl or simple aryl ligands, compared with several hundred $\mu\text{moles/ml}$ gel of C_4 – C_{18} alkyl ligands usually used for RPC adsorbents. Consequently, protein binding to RPC adsorbents is usually very strong, which requires the use of non-polar solvents for their elution. RPC has found extensive applications in analytical and preparative separations of mainly peptides and low molecular weight proteins that are stable in aqueous-organic solvents.

In summary, HIC is an alternative way of exploiting the hydrophobic properties of proteins, working in a more polar and less denaturing environment.

Compared with RPC, the polarity of the complete system of HIC is increased by decreased ligand density on the stationary phase and by adding salt to the mobile phase.

Factors affecting HIC

The main parameters to consider when selecting HIC media and optimizing separation processes on HIC media are:

- Ligand type and degree of substitution
- Type of base matrix
- Type and concentration of salt
- pH
- Temperature
- Additives

Type of ligand

The type of immobilized ligand (alkyl or aryl) determines primarily the protein adsorption selectivity of the HIC adsorbent (6,7,30). In general, straight chain alkyl (hydrocarbon) ligands show “pure” hydrophobic character while aryl ligands show a mixed mode behaviour where both aromatic and hydrophobic interactions are possible (30). It is also established that, at a constant degree of substitution, the protein binding capacities of HIC adsorbents increase with increased alkyl chain length (Fig. 2A) (30,31). The charged type HIC adsorbents (6,7) show an additional mode of interaction, which will not be discussed here. The choice between alkyl or aryl ligands is empirical and must be established by screening experiments for each individual separation problem.

Fig. 2.
The effect of alkyl chain length and degree of substitution on binding capacity in HIC. In Fig. 2A it is assumed that the degree of substitution is the same for each alkyl chain length shown.

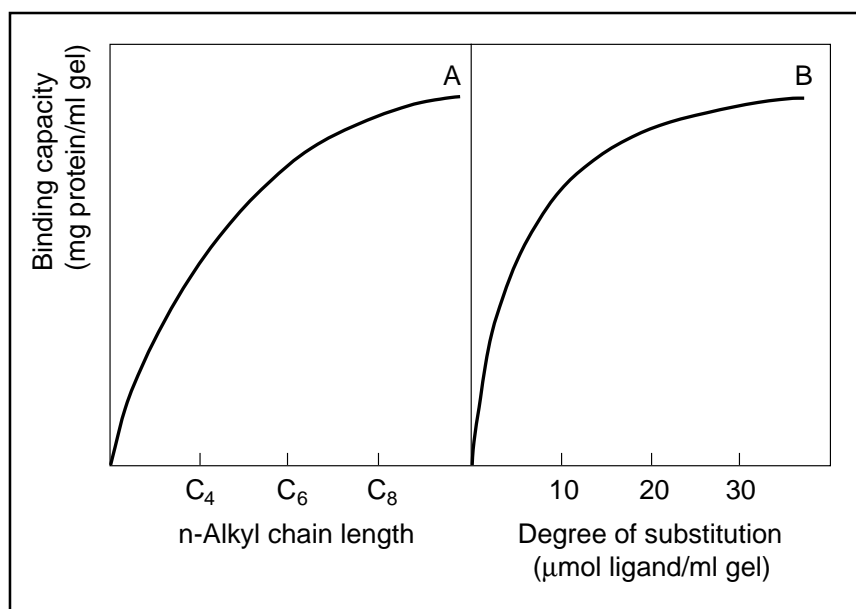

HIC media shown in Fig. 3 are all based on the glycidyl ether coupling procedure, which produces gels that are charge free and that should thus only have hydrophobic interactions with proteins. The phenyl group shown in Fig. 3-C also has a potential for π - π interactions. The glycidyl-ether coupling technique will introduce a short spacer but the effect of this will be very limited since the short hydrophobic chain is “neutralized” with the hydrophilic OH-group.

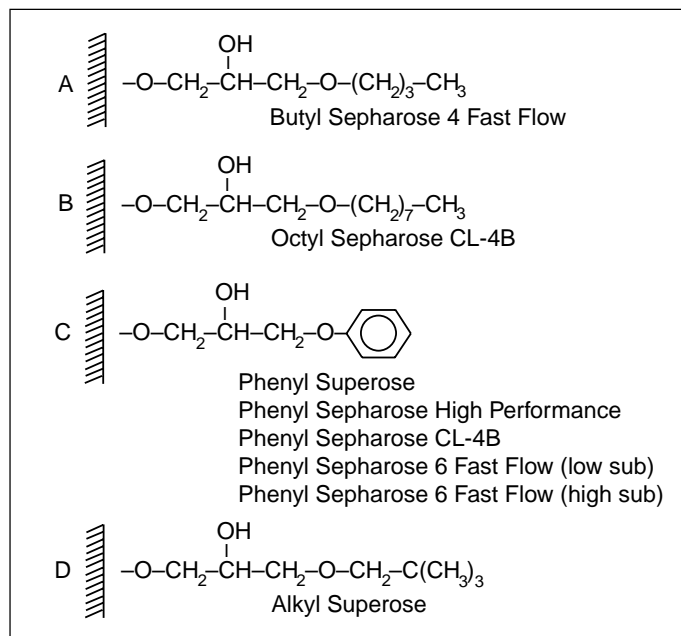

Fig. 3.
Different hydrophobic ligands coupled to cross-linked agarose matrices.

Degree of substitution

The protein binding capacities of HIC adsorbents increase with increased degree of substitution of immobilized ligand. At a sufficiently high degree of ligand substitution, the apparent binding capacity of the adsorbent remains constant (plateau is reached) but the strength of the interaction increases (31–33, 35) (Fig. 2B). Solutes bound under such circumstances are difficult to elute due to multi-point attachment (34).

Type of base matrix

It is important not to overlook the contribution of the base matrix. The two most widely used types of support are strongly hydrophilic carbohydrates, e.g. cross-linked agarose, or synthetic copolymer materials. The selectivity of a copolymer support will not be exactly the same as for an agarose based support substituted with the same type of ligand.

To achieve the same type of results on an agarose-based matrix as on a copolymer support, it may be necessary to modify adsorption and elution conditions.

Type and concentration of salt

The addition of various structure-forming (“salting out”) salts to the equilibration buffer and sample solution promotes ligand-protein interactions in HIC (10, 12, 36, 65, 66). As the concentration of such salts is increased, the amount of proteins bound also increases almost linearly up to a specific salt concentration and continues to increase in an exponential manner at still higher concentrations.

This latter phenomenon is demonstrated in Fig. 4 where total binding capacity of Phenyl Sepharose High Performance for α -chymotrypsinogen and RNase was examined at gradually increasing salt concentrations.

Fig. 4.
Protein binding capacity on Phenyl Sepharose High Performance as a function of salt concentration in the column equilibration buffer (Work from Amersham Pharmacia Biotech, Uppsala, Sweden).

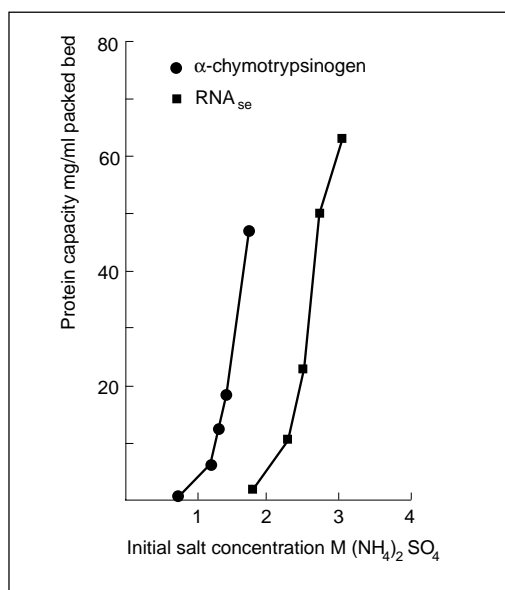

In this experiment, the column was first equilibrated with buffer containing varying concentrations of salt as indicated in the Figure. The sample was dissolved in buffer including this initial salt concentration prior to application to the column. However, in those experiments where the protein begins to precipitate at high salt concentration (1.3 M and 2.3 M ammonium sulphate for α -chymotrypsinogen and RNase respectively) the sample was dissolved at a slightly lower salt concentration.

The samples were loaded on the column until breakthrough could be observed at the column outlet. Then start buffer with initial salt concentration was run through the column until UV-absorption in the eluent returned to the baseline. Finally, the bound proteins were eluted with a decreasing salt gradient.

A significant increase in adsorption capacity can be seen when the salt concentration is increased above the precipitation point.

This phenomenon is probably due to the precipitation of proteins on the column. It has a concomitant negative effect on the selectivity of the HIC adsorbent.

The effects of salts in HIC can be accounted for by reference to the Hofmeister series for the precipitation of proteins or for their positive influence in increasing the molal surface tension of water (for extensive review, see refs. 27,29). These effects are summarized in Tables 1 and 2.

<p>← Increasing precipitation (“salting -out”) effect</p> <p>Anions: PO_4^{3-}, SO_4^{2-}, $\text{CH}_3 \bullet \text{COO}^-$, Cl^-, Br^-, NO_3^-, ClO_4^-, I^-, SCN^-</p> <p>Cations: NH_4^+, Rb^+, K^+, Na^+, Cs^+, Li^+, Mg^{2+}, Ca^{2+}, Ba^{2+}</p> <p>Increasing chaotropic (“salting-in”) effect →</p>

Table 1.
The Hofmeister series on the effect of some anions and cations in precipitating proteins.

<p>$\text{Na}_2\text{SO}_4 > \text{K}_2\text{SO}_4 > (\text{NH}_4)_2\text{SO}_4 > \text{Na}_2\text{HPO}_4 > \text{NaCl} > \text{LiCl} \dots > \text{KSCN}$</p>

Table 2.
Relative effects of some salts on the molal surface tension of water.

In both instances, sodium, potassium or ammonium sulphates produce relatively higher “salting-out” (precipitation) or molal surface tension increment effects. It is also these salts that effectively promote ligand-protein interactions in HIC. Most of the bound proteins are effectively desorbed by simply washing the HIC adsorbent with water or dilute buffer solutions at near neutral pH.

Effect of pH

The effect of pH in HIC is also not straightforward. In general, an increase in pH weakens hydrophobic interactions (10,41), probably as a result of increased titration of charged groups, thereby leading to an increase in the hydrophilicity of the proteins. On the other hand, a decrease in pH results in an apparent increase in hydrophobic interactions. Thus, proteins which do not bind to a HIC adsorbent at neutral pH bind at acidic pH (9). Hjertén *et al.* (42) found that the retention of proteins changed more drastically at pH values above 8.5 and/or below 5 than in the range pH 5–8.5 (Fig 5).

These findings suggest that pH is an important separation parameter in the optimization of hydrophobic interaction chromatography and it is advisable to check the applicability of these observations to the particular separation problem at hand.

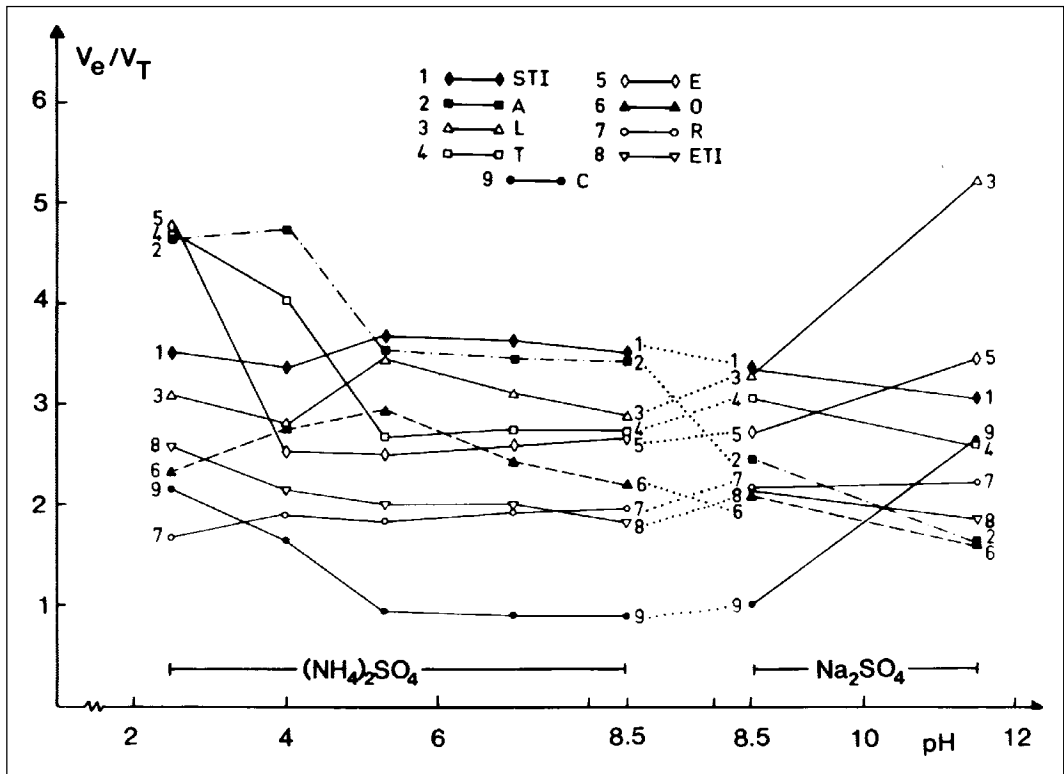

Fig. 5. The pH dependence of the interaction between proteins and an octyl agarose gel expressed as V_e/V_T (V_e is the elution volume of the different proteins and V_T is the elution volume of a non-retarded solute). Elution was by a negative linear gradient of salt. The model proteins used were STI=soy trypsin inhibitor, A=human serum albumin, L=lysozyme, T=transferrin, E=enolase, O=ovalbumin, R=ribonuclease, ETI=egg trypsin inhibitor and C=cytochrome c. (Reproduced with permission, from ref. 42).

Effect of temperature

Based on theories developed for the interaction of hydrophobic solutes in water (22,37), Hjertén (38) proposed that the binding of proteins to HIC adsorbents is entropy driven [$\Delta G = (\Delta H - T\Delta S) \sim -T\Delta S$], which implies that the interaction increases with an increase in temperature. Experimental evidence to this effect has been presented by Hjertén (25) and Jennissen (34). It is interesting to note that the van der Waals attraction forces, which operate in hydrophobic interactions (29), also increase with increase in temperature (39). However, an opposite effect was reported by Visser & Strating (40) indicating that the role of temperature in HIC is of a complex nature. This apparent discrepancy is probably due to the differential effects exerted by temperature on the conformational state of different proteins and their solubilities in aqueous solutions.

In practical terms, one should thus be aware that a downstream purification process developed at room temperature might not be reproduced in the cold room, or *vice versa*.

Additives

Low concentrations of water-miscible alcohols, detergents and aqueous solutions of chaotropic (“salting-in”) salts result in a weakening of the protein-ligand interactions in HIC leading to the desorption of the bound solutes. The non-polar parts of alcohols and detergents compete effectively with the bound proteins for the adsorption sites on the HIC media resulting in the displacement of the latter. Chaotropic salts affect the ordered structure of water and/or that of the bound proteins. Both types of additives also decrease the surface tension of water (see Table 3) thus weakening the hydrophobic interactions to give a subsequent dissociation of the ligand-solute complex.

Although additives can be used in the elution buffer to affect selectivity during desorption, there is a risk that proteins could be denatured or inactivated by exposure to high concentrations of such chemicals. However, additives can be very effective in cleaning up HIC columns that have strongly hydrophobic proteins bound to the gel medium.

Solvent	Viscosity (centipoise)	Dielectric constant	Surface tension (dynes/cm)
Water	0.89	78.3	72.00
Ethylene glycol	16.90	40.7	46.70
Dimethyl Sulphoxide	1.96	46.7	43.54
Dimethyl Formamide	0.796	36.71	36.76
n-propanol	2.00	20.33	23.71

Table 3.
Physical properties of some
solvents used in HIC (data at 25 °C).

Product Guide

Amersham Pharmacia Biotech manufactures a wide range of HIC media suitable for analytical, small scale preparative and process scale applications. The HIC product range is summarized in Table 4.

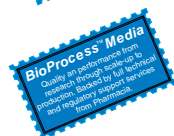

Phenyl Sepharose 6 Fast Flow (low sub) Phenyl Sepharose 6 Fast Flow (high sub) Butyl Sepharose 4 Fast Flow Octyl Sepharose 4 Fast Flow*	Suitable for all initial and intermediate step purifications. Available in laboratory pack sizes and bulk quantities.
Phenyl Sepharose High Performance	Suitable for all high resolution purifications. Available in laboratory pack sizes, bulk quantities and as prepacked columns.
Phenyl Sepharose CL-4B Octyl Sepharose CL-4B	Traditional medium for all applications. Available in laboratory pack sizes and bulk quantities.
Alkyl Superose and Phenyl Superose	For analytical and small scale preparative applications. Available as prepacked columns.
HIC Media Test Kit	For screening different types of ligands and for method development work at small scale. Five different HIC media as prepacked 1 ml columns.

Table 4.
HIC products available from Amersham Pharmacia Biotech.

* Octyl Sepharose 4 Fast Flow is currently (December 1992) only available as a CDM product (see p. 17), but will later be available as a standard catalogue product.

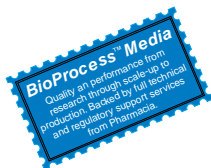

BioProcess Media

BioProcess™ Media form a full range of separation media especially designed to meet the demands of today's industrial production of biomolecules.

- Productive:** High flow rates, high capacity and high recovery lead to good process economy.
- Validated:** Manufactured according to fully validated process with strict quality standards and complete documentation.
- Scaleable:** Work equally well in laboratory and pilot production systems as well as in industrial operation.
- Cleanable:** Very high chemical stability enables thorough cleaning and sanitization treatments that reduce the risk of contamination of the end product and increase the media lifetime.
- Documented:** Regulatory Support Files give full details of approval support data such as performance, stability (including leakage data), extractable compounds and analytical methods. A Regulatory Support File is an invaluable starting point, especially for pharmaceutical process validations.
- Guaranteed supply:** Large production capacity and guaranteed future supply.

Base matrices

The BioProcess HIC media range is based on the highly cross-linked beaded agarose matrices Sepharose Fast Flow and Sepharose High Performance. Their macrostructures containing polysaccharide chains arranged in bundles (Fig. 6) are further strengthened by different degrees of inter-chain cross-linking. The resulting macroporous structures combine good capacities for molecules up to 4×10^6 (6% agarose) and 2.7×10^7 (4% agarose) in molecular mass with excellent flow properties and high physical and chemical stability.

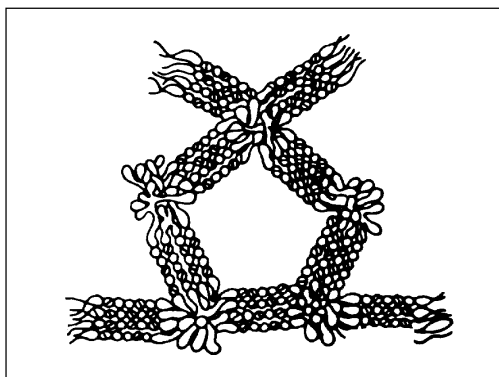

Fig. 6.
Structure of cross-linked agarose gels.

All Sepharose based matrices have virtually no non-specific adsorption properties and are also resistant to microbial degradation due to the presence of the unusual sugar 3,6-anhydro-L-galactose.

Coupling

The HIC ligands are coupled to the monosaccharide units by stable ether linkages. The structures of the coupled ligands are shown in Fig. 3.

Chemical stability

BioProcess HIC Media are stable in all commonly used aqueous buffers and solvents in the pH range 2-14. When these media were challenged by storage for 7 days at 40°C in the solutions listed in Table 5, no significant change in chromatographic function was seen.

Of special interest is their stability in alkaline solutions, as cleaning and sanitization with NaOH solutions are preferred in process applications. The functional stability and recommended pH ranges are summarized in Table 6.

The ligand leakage of BioProcess HIC Media at different pH values has been tested and generally found to be extremely low (43). The pH range 2–14 can be used for cleaning-in-place (CIP) and sanitization-in-place (SIP), see “Cleaning, sanitization and sterilization procedures”, page 63. BioProcess HIC Media are stable at high temperatures and can be sterilized by autoclaving at 120°C for 20 min.

Table 5. Chemical stability test of BioProcess HIC Media.

Tested media	Test solutions							
	1 M NaOH	1 M acetic acid	1 mM HCL	3 M (NH ₄) ₂ SO ₄	70% ethanol	30% isopropanol	6 M GuHCl	8 M Urea
Phenyl Sepharose 6 Fast Flow (low sub)	X	(n. t.)	(n. t.)	X	X	X	X	X
Phenyl Sepharose 6 Fast Flow (high sub)	X	(n. t.)	(n. t.)	X	X	X	X	X
Butyl Sepharose 4 Fast Flow	X	(n. t.)	X	(n. t.)	X	X	X	(n. t.)
Phenyl Sepharose High Performance	X	X	(n. t.)	(n. t.)	X	X	X	X

X = Functionally stable when tested for 7 days at +40°C
(n. t.) = Not tested

Table 6. Stability and recommended pH ranges for BioProcess HIC Media.

Long term stability and recommended working pH range:	3–13
Short term stability and recommended CIP and SIP pH range:	2–14
Recommended long term storage:	0.01 M NaOH or 20% ethanol.

Physical stability

The highly cross-linked structures of Sepharose Fast Flow and Sepharose High Performance matrices are physically stable resulting in very good flow properties. This is illustrated by the pressure-flow rate curves for Phenyl Sepharose 6 Fast Flow shown in Fig. 7. In columns with 5 cm inner diameter and a bed height of 15 cm, flow rates up to 500 cm/h can be used without exceeding a back pressure of 1 bar. The optimal working flow rate during elution is normally 50–150 cm/h but during equilibration, regeneration, and also often during sample application, higher flow rates of 200–300 cm/h can be used. These higher flow rates reduce cycle times.

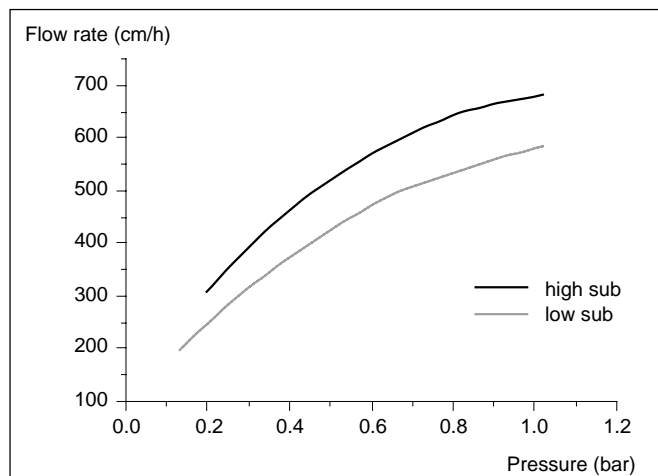

Fig. 7. Typical pressure/flow rate curves for Phenyl Sepharose 6 Fast Flow (low sub) and Phenyl Sepharose 6 Fast Flow (high sub) in an XK 50/30 Column, bed height 15 cm, mobile phase 0.1 M NaCl. (Work from Amersham Pharmacia Biotech, Uppsala, Sweden).

Binding capacity

One of the major features of BioProcess HIC Media is the high binding capacity, which results in high throughput and productivity even at relatively low salt concentrations. Fig. 8 shows the total dynamic binding capacities of human serum albumin and human IgG at different concentrations of ammonium sulphate as determined by frontal analysis. Phenyl Sepharose 6 Fast Flow (high sub) showed the highest capacities for both hIgG and HSA. Phenyl Sepharose High Performance had higher capacity for hIgG compared with HSA while Butyl Sepharose 4 Fast Flow showed the reverse, indicating the difference in selectivity. The protein recoveries when eluting with low salt buffer were all 80% or more.

The dynamic binding capacity will decrease with increasing linear flow rates. This is especially important to consider when optimizing initial separation steps where large volumes need to be processed. Productivity may be higher at high flow rates even though the binding capacity is decreased.

Fig. 8.
Total adsorption capacities of Phenyl and Butyl Sepharose media for human IgG and HSA as a function of the concentration of ammonium sulphate in the equilibration buffer. 1=Phenyl Sepharose 6 Fast Flow (high sub), 2=Phenyl Sepharose High Performance, 3=Phenyl Sepharose 6 Fast Flow (low sub), 4=Butyl Sepharose 4 Fast Flow. (Work from Amersham Pharmacia Biotech, Uppsala, Sweden).

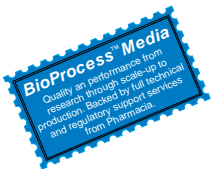
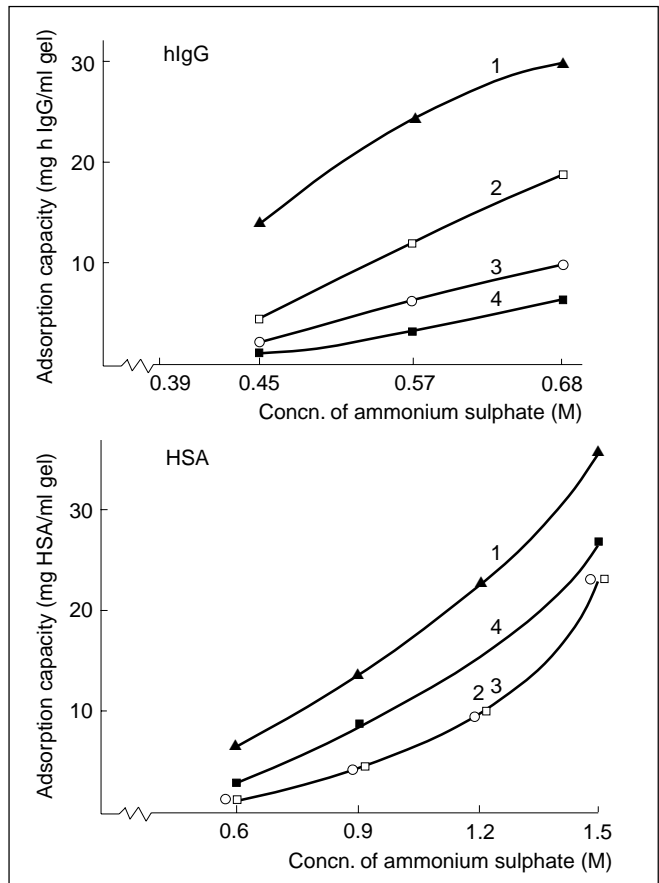

Phenyl Sepharose 6 Fast Flow (low sub) Phenyl Sepharose 6 Fast Flow (high sub)

Phenyl Sepharose 6 Fast Flow (low sub) and Phenyl Sepharose 6 Fast Flow (high sub) are based on highly cross-linked 6% agarose with phenyl ligands coupled via stable ether linkages. The media characteristics are summarized in Table 7.

Phenyl Sepharose 6 Fast Flow (low sub) and Phenyl Sepharose 6 Fast Flow (high sub) were initially developed and tested in cooperation with leading pharmaceutical manufacturers. They are ideal for initial or intermediate step purification of proteins

Table 7.
Characteristics of Phenyl Sepharose 6 Fast Flow (low sub) and Phenyl Sepharose 6 Fast Flow (high sub).

Bead structure	cross-linked agarose, 6%, spherical
Mean particle size	90 µm
Particle size range	45–165 µm
Degree of substitution	approx. 20 (low sub) and 40 (high sub) µmol phenyl groups/ml gel

Further information is available in Data File 2040 (Code No. 18-1020-53).

and peptides with a low to medium degree of hydrophobicity. The availability of two degrees of substitution increases the possibility of finding the best selectivity and capacity for a given application.

Phenyl Sepharose 6 Fast Flow (high sub) has been used as an effective capture step in methods for the purification of recombinant human Epidermal Growth Factor (h-EGF) and recombinant *Pseudomonas aeruginosa* exotoxin. These applications are presented in chapter 6, pages 87 and 92 respectively.

Product availability

Phenyl Sepharose 6 Fast Flow (low sub) and Phenyl Sepharose 6 Fast Flow (high sub) are supplied as suspensions in 20% ethanol in packs of 200 ml, 1 litre and 5 litres.

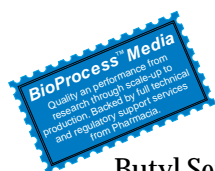

Butyl Sepharose 4 Fast Flow

Butyl Sepharose 4 Fast Flow is based on highly cross-linked 4% agarose with butyl ligands coupled via stable ether linkages. The characteristics of this medium are summarized in Table 8.

Bead structure	cross-linked agarose, 4%, spherical
Mean particle size	90 µm
Particle size range	45–165 µm
Degree of substitution	approx. 50 µmol butyl groups/ml gel

Table 8.
Characteristics of Butyl Sepharose 4 Fast Flow.

Further information is available in Data File 3300 (Code No. 18-1020-70).

Butyl Sepharose 4 Fast Flow was initially developed and tested in cooperation with leading pharmaceutical manufacturers. It is intended for the initial or intermediate step purification of proteins and peptides with a low to medium degree of hydrophobicity and often works efficiently with rather low salt concentrations.

For the butyl ligand, the mechanism of adsorption and desorption is different than for the phenyl ligand, which gives a difference in selectivity. This was illustrated in an application where recombinant human Annexin V, expressed in *E. coli*, was purified using HIC after an initial capture step on a cation exchanger. A comparison of the chromatograms in Fig. 9 shows that the elution position of Annexin V and the main impurities interchanged when changing from Butyl Sepharose 4 Fast Flow to Phenyl Sepharose 6 Fast Flow (high sub).

Product availability

Butyl Sepharose 4 Fast Flow is supplied as suspension in 20% ethanol in packs of 200 ml, 500 ml and 5 litres.

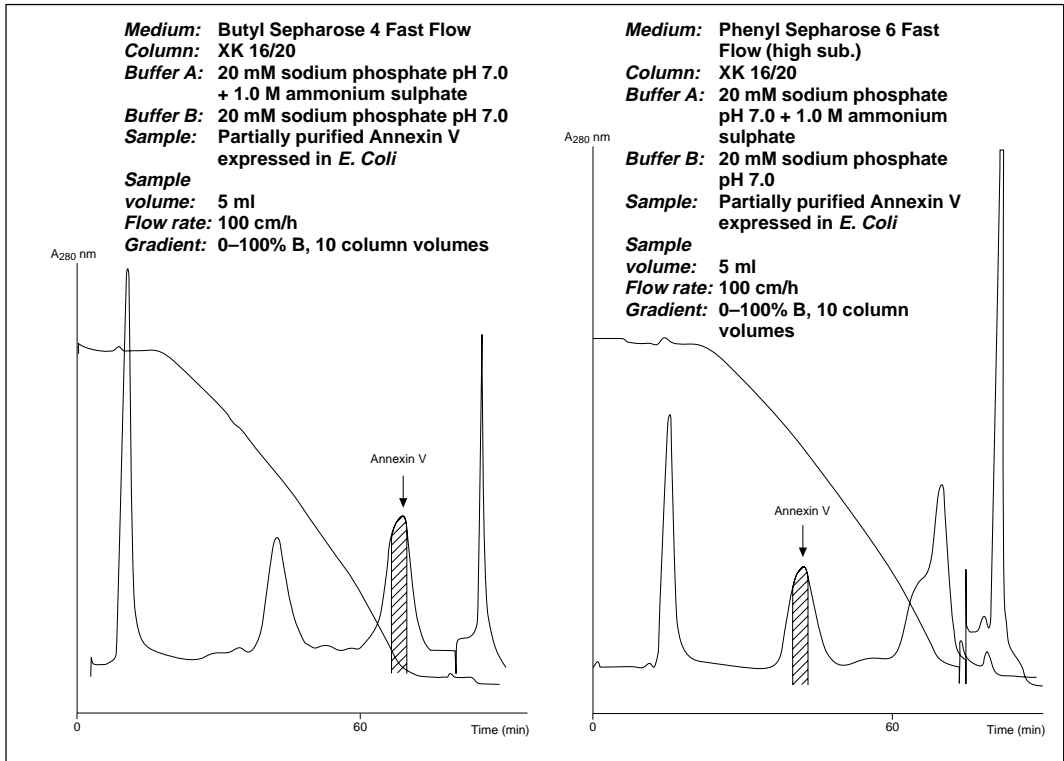
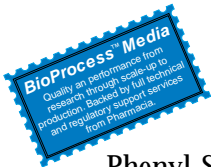

Fig. 9. Purification of Annexin V on Butyl Sepharose 4 Fast Flow and Phenyl Sepharose 6 Fast Flow (high sub). (Work from Amersham Pharmacia Biotech, Uppsala, Sweden).



Phenyl Sepharose High Performance

Phenyl Sepharose High Performance is based on very highly cross-linked 6% agarose with phenyl ligands coupled via stable ether linkages. The characteristics of this medium are summarized in Table 9.

Table 9.
Characteristics of Phenyl Sepharose High Performance.

Bead structure	cross-linked agarose, 6%, spherical
Mean particle size	34 μm
Particle size range	24–44 μm
Degree of substitution	approx. 25 $\mu\text{mol phenyl/ml gel}$

Further information is available in Data File 2050 (Code No. 18-1020-56).

Phenyl Sepharose High Performance is ideal for laboratory and process scale intermediate step purifications where high resolution is needed. The separation of slightly modified variants, clipped forms etc., of a recombinant protein from the native protein is a typical application example. It has also proven to be very efficient for the purification of monoclonal antibodies. Two large scale applications on monoclonal

antibodies, one for the purification of anti-gp120, which is in clinical trials for treatment of AIDS, the other for the purification of an antibody used in diagnostic tests, are presented in Chapter 6, pages 85 and 90 respectively.

Product availability

Phenyl Sepharose High Performance is supplied as a suspension in 20% ethanol in packs of 75 ml, 1 litre and 5 litres and prepacked in HiLoad™ 16/10 and 26/10 columns.

Custom Designed HIC Media

Custom Designed Media (CDM) meet the needs of specific industrial process separations where chromatography media from our standard range are not suitable. CDM can be made to meet BioProcess Media specifications if required.

The CDM group at Amersham Pharmacia Biotech works in close collaboration with the customer to design, manufacture, test and deliver media for specialized separation requirements. Several CDM products are also available to the general market. Some HIC media first produced as Custom Designed Media have proven so successful that they have subsequently been introduced as standard products, e.g. Phenyl Sepharose 6 Fast Flow (low sub), Phenyl Sepharose 6 Fast Flow (high sub) and Butyl Sepharose 4 Fast Flow.

Product availability

Please contact your local Amersham Pharmacia Biotech representative for further details of CDM products and services.

HIC Media Test Kit

HIC Media Test Kit consists of five ready-to-use 1 ml plastic columns for screening different types of ligands and for method development work at small scale.

The kit contains the following HIC media:

- **Phenyl Sepharose High Performance**
- **Phenyl Sepharose 6 Fast Flow (low sub)**
- **Phenyl Sepharose 6 Fast Flow (high sub)**
- **Butyl Sepharose 4 Fast Flow**
- **Octyl Sepharose 4 Fast Flow**

Product availability

Please contact your local Amersham Pharmacia Biotech representative for further information.

Phenyl Sepharose CL-4B and Octyl Sepharose CL-4B

Phenyl Sepharose CL-4B and Octyl Sepharose CL-4B are produced in large quantities with high and consistent quality. Their performance has been demonstrated in hundreds of applications and they have been approved by regulatory authorities for use in many pharmaceutical production processes.

Phenyl Sepharose CL-4B and Octyl Sepharose CL-4B are based on cross-linked 4% agarose matrices with ligands coupled via stable ether linkages. The media characteristics are summarized in Table 10.

Table 10.
Characteristics of Phenyl Sepharose CL-4B and Octyl Sepharose CL-4B.

Bead structure	cross-linked agarose, 4%, spherical
Mean particle size	90 µm
Particle size range	45-165 µm
Degree of substitution	approx. 40 µmol phenyl or octyl groups/ml gel

Phenyl Sepharose CL-4B and Octyl Sepharose CL-4B are stable in all commonly used aqueous buffers. Long term stability and recommended working pH range is 3–12. 1 M NaOH can be used for short term exposure in cleaning and sanitization procedures, see “Cleaning, sanitization and sterilization procedures”, page 63. Short term stability and recommended CIP and SIP pH range is 2–14.

Maximum flow rate for a laboratory-scale column with an internal diameter of up to 5 cm and a bed height of up to 15 cm is 150 cm/h.

Product availability

Phenyl Sepharose CL-4B and Octyl Sepharose CL-4B are supplied as suspensions in 20% ethanol in packs of 50 ml, 200 ml and 10 litres.

Phenyl Superose and Alkyl Superose

Phenyl Superose and Alkyl Superose are media for high performance HIC, available in prepacked columns for use in FPLC™, SMART™ System (Phenyl Superose only) or HPLC systems.

Phenyl and neopentyl groups respectively are attached to the matrix via a stable ether linkage. The characteristics of these media and columns are summarized in Table 11.

Bead structure	cross-linked agarose, 12%, spherical
Mean particle size	13 μm
Column sizes	5x50 mm (HR 5/5) 10x100 mm (HR 10/10) 1.6x50 mm (Phenyl Superose, PC 1.6/5 for SMART System)

Table 11.
Characteristics of Phenyl Superose and Alkyl Superose.

Further information is available in Data File for prepacked HR columns (Code No. 18-1009-26) and in Data File for prepacked PC columns (Code No. 18-1009-02).

Phenyl Superose and Alkyl Superose are stable in all commonly used aqueous buffers. Long term stability and recommended working pH range is 2–13. 1 M NaOH can be used for cleaning and sanitization, see “Cleaning, sanitization and sterilization procedures”, page 63. Short term stability and recommended CIP and SIP pH range is 2–14.

The columns are typically used in laboratory scale protein purification schemes or as an analytical tool, as a complement to e.g. ion exchange chromatography and gel filtration. Examples of applications are shown in chapter 6, page 79–83. Suitable protein loads are in the mg range (HR columns) or, for micropurification, in the ng- μg range (Phenyl Superose, PC 1.6/5). Alkyl Superose is less hydrophobic than Phenyl Superose and is therefore particularly suitable for high performance HIC with retained biological activities of labile proteins and of proteins which bind very tightly to media with higher hydrophobicities.

Experimental Design

This chapter will deal with experimental methods of HIC which are applicable in the majority of cases. Since the factors which influence HIC are numerous, the relevant chromatographic parameters that lead to the selective purification of the protein(s) of interest should be optimized on a case to case basis.

Hydrophobicity of proteins

It is estimated that as much as 40–50% of the accessible surface area of proteins is non-polar (44, 45). These areas are responsible for the binding of proteins to HIC adsorbents in the presence of moderate to high concentrations of salting-out salts. The strength of this salt-promoted interaction may be predicted from the close relationship between precipitation data for proteins and their relative retention on HIC adsorbents (27). Since such retention data are not readily available for the large majority of proteins, they must be established from case to case for the protein(s) of interest in a biological sample.

Multivariate mapping

This is a useful method for:

- i. Characterizing hydrophobic media on the basis of their selectivity (46).
- ii. Choosing the most suitable medium for the optimum resolution of two closely related proteins.
- iii. Determining the adsorption behaviour of proteins on HIC media and thereby establishing a “practical hydrophobic scale” for the proteins in question.

The results obtained in our laboratories (46) suggest that:

- i. The adsorption selectivity of Octyl Sepharose CL-4B is related to the fraction of hydrophobic amino acids in the model proteins examined.
- ii. The retention of proteins on alkyl Superose and Pyridine sulphide-Sepharose 6 Fast Flow is proportional to a parameter best described as “absence of surface charge” on the sample molecules.
- iii. The phenyl- and butyl-based media separated proteins according to a combination of the above two mechanisms.
- iv. Different hydrophobicity coefficients co-vary with the retention data established for the various hydrophobic media examined.

Multivariate analysis thus opens new possibilities in the design of HIC and other chromatography-based separations by using a minimum number of experimental data.

Strategic considerations

One of the most important aspects of developing a complete purification scheme is to keep the number of unit operations to a minimum. A logical approach to reach the highest possible purity with the smallest number of individual chromatographic steps is to combine techniques based on different principles and thus exploit different surface properties of the substances to be separated. However, the sequence in which the chosen techniques are used must be carefully planned. In many applications HIC is useful especially in combination with techniques such as ion exchange chromatography and gel filtration. As an example, hydrophobic interaction chromatography is a logical choice when the sample already has a high ionic strength. The conductivity of most biological starting materials is typically in the range of 15–30 mS/cm, which makes HIC an attractive alternative to ion exchange chromatography (IEX) in the first step of a downstream purification scheme. High conductivity in the starting material will reduce the binding capacity of ion exchange media and some type of conditioning such as desalting, diafiltration or dilution has to be included before an ion exchange step. In contrast, the only conditioning needed if HIC is used, is to add enough salt to promote the proper binding to the medium. Used in the first step HIC, like IEX and other adsorption techniques, will serve as an effective means of concentrating a dilute sample.

Other typical points in a purification scheme where HIC fits in naturally are after an ammonium sulphate precipitation, which often comes in the beginning of a downstream process, and after an ion exchange step where the sample is eluted with a rather high ionic strength. The further addition of salt that might be needed to retard the components in a desired way on the HIC medium is thus a very simple linking step.

In a similar way, a sample eluted from a HIC step in a low ionic strength buffer can often be directly applied to an ion exchange column without an extra dialysis or desalting step.

Choice of HIC media

The type of immobilized ligand, the degree of substitution and the type and concentration of salt and pH used during the adsorption stage have a profound effect on the overall performance (i.e., selectivity and capacity) of a HIC medium [see Chapter 2]. Moreover, the type of matrix used and the coupling chemistry can also influence to a variable degree the binding and elution behaviour of many proteins. The practical implications of these effects are that different HIC media must be compared much more rigorously than ion exchange or affinity media, especially when the HIC step is part of a downstream purification process intended for an industrial scale operation.

General considerations

- i. The HIC medium should bind the protein of interest at a reasonably low concentration of salt. This is often dependent on the type of salt chosen, e.g. up to four times higher concentration of NaCl might be necessary to obtain a binding effect comparable to that obtained with ammonium or sodium sulphate. The salt concentration should be below the concentration that causes precipitation of different proteins in the crude feed stock. 1 M ammonium sulphate is a good starting point for screening experiments. If the substance does not bind in e.g. 1 M ammonium sulphate, then choose a more hydrophobic medium. The right choice of a suitable HIC medium can often lead to a lower consumption of salt in the binding buffer. This in turn has a direct bearing on the economic and environmental aspects of the purification process, especially for large-scale HIC applications.
- ii. The bound protein should be eluted from the column with salt-free buffer and with high recovery (75% or higher). If non-polar solvents are required for its elution, try a less hydrophobic medium.
- iii. The pH of the start buffer and the type of salt to use are both parameters that can be exploited to maximize selectivity during the adsorption phase. This is done by checking the adsorption properties of the media at different pH-values and with different types of salts during the screening of different ligands.
- iv. Since hydrophobic interaction is dependent on temperature, it is important that method development work is performed at the intended final working temperature.

Screening experiments

This section outlines a general procedure for performing HIC screening experiments where emphasis is laid on optimizing selectivity by proper choice of HIC medium and by roughly defining the most critical experimental parameters. It also presents some typical elution profiles that could be obtained in a variety of situations followed by relevant discussions of the results and recommendations for further experimental work.

- i. Pack the media in suitable columns according to our packing recommendations (a bed volume of 1–10 ml is adequate) or use the **HIC Media Test Kit** from Amersham Pharmacia Biotech. The HIC Media Test Kit consists of five 1 ml plastic columns prepacked with BioProcess HIC media. For more information about the HIC Media Test Kit, see Chapter 3, Selection Guide.
- ii. Equilibrate the column with 2 bed volumes of the equilibration Buffer A (50 mM sodium phosphate, 1.0 M ammonium sulphate, pH 7.0). Use a constant flow rate throughout (e.g. 100 cm/h).
- iii. Apply a suitable amount of sample, also containing 1.0 M ammonium sulphate (pH adjusted to 7.0), to the column and wash with 2–3 column volumes of Buffer A, or until the UV-trace of the effluent returns to near baseline.
- iv. Elute the bound fraction using a linear and descending salt gradient from 0 to 100% Buffer B (50 mM sodium phosphate buffer, pH 7.0). A total gradient volume of 10 bed volumes is usually sufficient.

Evaluation of results

Figs. 10 to 15 show some typical elution profiles that could be obtained from screening experiments. The shaded area shows the elution position of the protein of interest. Each chromatogram is accompanied by a general discussion of the results and suggestions for further experiments to optimize the separation of the protein of interest.

Fig. 10.

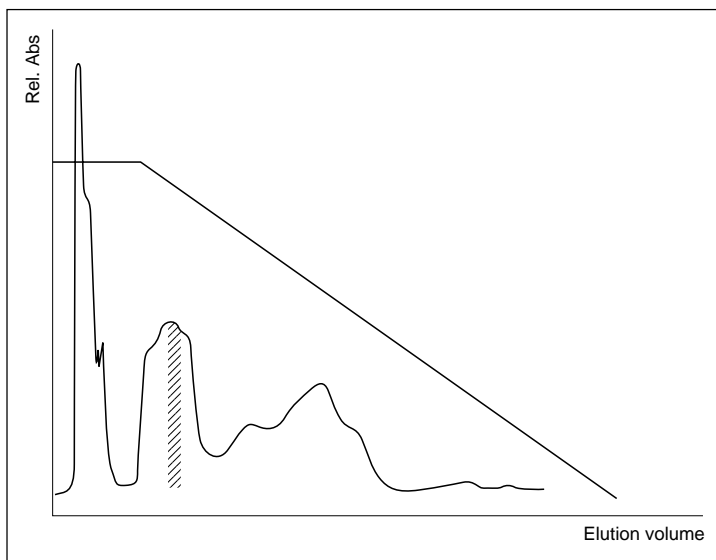

Result: Product is eluted early in gradient. Resolution is not satisfactory.

Discussion: Not much can be gained in this situation by changing salt concentration. Decreasing the salt concentration will decrease the binding capacity of the protein of interest and might even lead to its elution together with the unbound fraction.

Increasing the salt concentration might lead to the co-adsorption of unwanted impurities and thereby lead to a decrease in the selectivity of the adsorbent for the protein of interest.

Changing the pH of the equilibration buffer might result in stronger binding and higher selectivity for the protein of interest. The effect of pH is variable for different proteins and usually a lowering of the pH leads to increased binding of proteins. Increasing the pH usually leads to a decreased binding of proteins, which, in this particular case, might result in the elution of the protein of interest together with the unbound fraction.

Next step: Repeat the experiment at a lower and a higher pH. If no improvement in selectivity is obtained – TRY A MEDIUM WITH A DIFFERENT LIGAND or, if available, A MEDIUM WITH A HIGHER DEGREE OF LIGAND SUBSTITUTION.

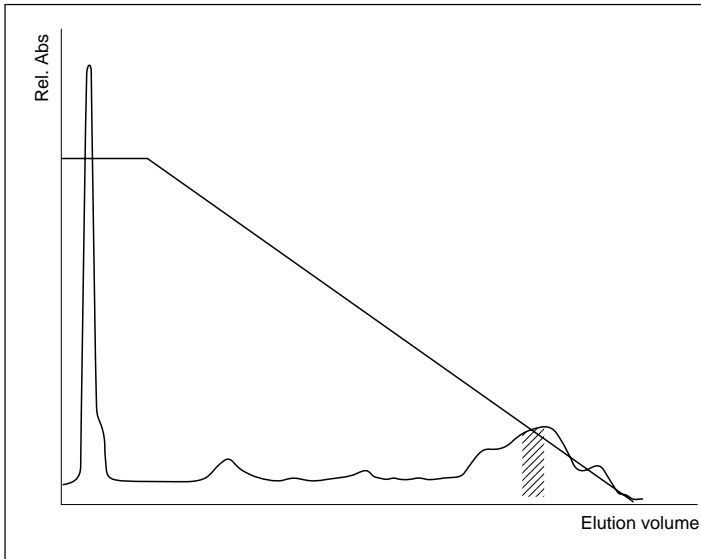

Fig. 11.

Result: Product is eluted near the end of the gradient.
Resolution is not satisfactory

Discussion: A decrease of the salt concentration will weaken the strength of binding resulting in the earlier elution of the protein of interest. It may also have a positive effect on selectivity since more of the less hydrophobic substances will be eluted together with the unbound fraction. However, the effect of this approach on the resolution is marginal since the contaminants are eluted very close to the protein of interest, both before and after. Changing the pH of the equilibration buffer may have a positive effect on resolution and should be tried.

Next step: Repeat the experiment at a higher and a lower pH of the equilibration buffer. If no improvement in resolution is obtained – TRY A MEDIUM WITH A DIFFERENT LIGAND or, if available, A MEDIUM WITH A LOWER DEGREE OF LIGAND SUBSTITUTION.

Fig. 12.

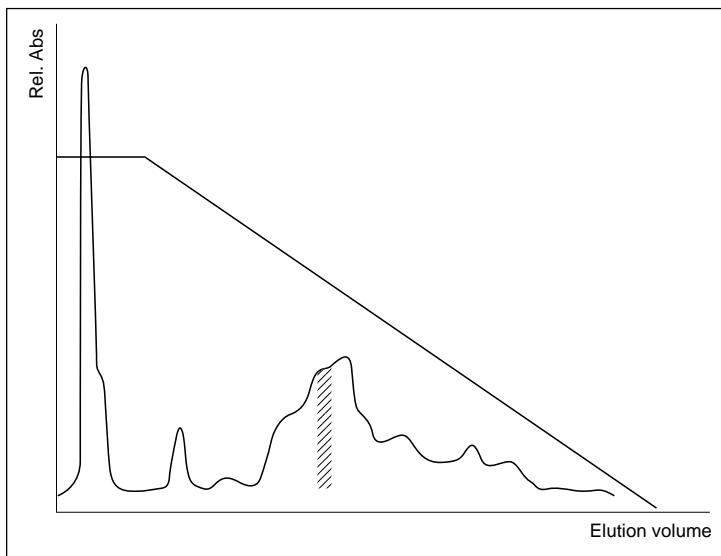

Result: Product is eluted in the middle of the gradient.
Resolution is not satisfactory.

Discussion: Changing the concentration of salt in the equilibration buffer will have a limited effect on resolution. However, a change of pH of the equilibration buffer (both lower and higher pH values) might have a favourable effect.

Next step: Repeat the experiment at a higher and a lower pH value. If no improvement in resolution is obtained – TRY A MEDIUM WITH A DIFFERENT LIGAND or, if available, A MEDIUM WITH A HIGHER DEGREE OF LIGAND SUBSTITUTION.

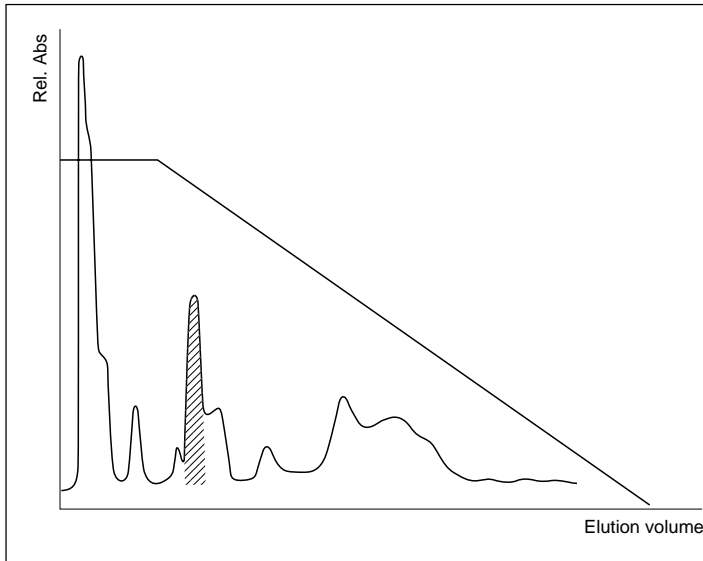

Fig. 13.

Result: Product is eluted early in gradient. Resolution is satisfactory.

Discussion: In principle, this can be a good choice of medium. However, the fact that the protein of interest is eluted very early in the gradient indicates that the binding capacity may be low. This might be compensated for, if necessary, by a moderate increase of the salt in the equilibration buffer. This in turn may lead to a decrease in the selectivity of the adsorbent since some of the unbound proteins might be adsorbed together with the protein of interest. Another negative effect of increased salt concentration may be a decrease in resolution caused by the increase in gradient slope if the total gradient volume, or the cycle time, is kept constant. Increased salt concentration will also give increased costs which may be of importance if the HIC step is to be a part of a manufacturing process. Finally, not much can be gained by changing the pH of the equilibration buffer since the resolution obtained was considered to be satisfactory.

Next step: Continue with method development as outlined under “Optimizing a HIC step”.

If low binding capacity is a problem and problems with increased salt concentration as outlined above are encountered – TRY A MEDIUM WITH A DIFFERENT LIGAND or, if available, A MEDIUM WITH A HIGHER DEGREE OF LIGAND SUBSTITUTION.

Fig. 14.

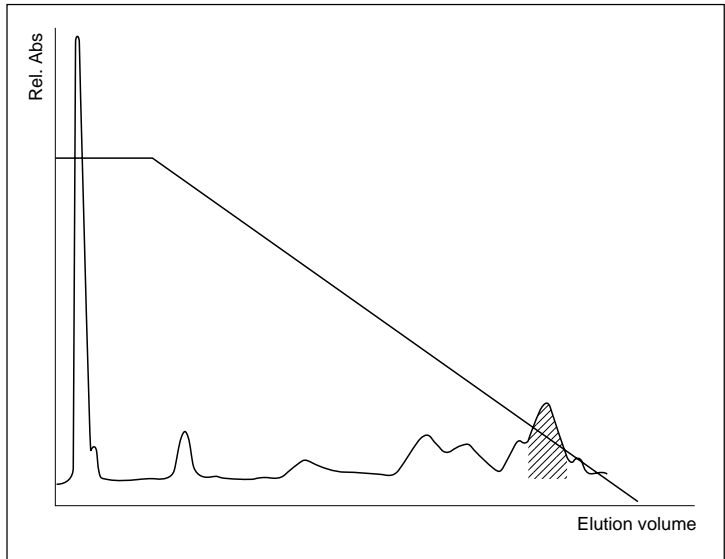

Result: Product is eluted near the end of the gradient. Resolution is satisfactory.

Discussion: This can also be a good choice of medium. Decreasing the concentration of salt in the equilibration buffer will give earlier elution of the protein of interest, reduced cycle time and decreased cost for salt.

A disadvantage in this situation might be that some of the most hydrophobic contaminating substances bind so strongly that some organic solvent or chaotropic agent has to be used for their removal.

Not much can be gained by changing pH since the selectivity is already good.

Next step: Continue with method development as outlined under “Optimizing a HIC step”. If problems with very strong binding of hydrophobic contaminants are encountered – TRY A MEDIUM WITH A DIFFERENT LIGAND or, if available, A MEDIUM WITH A LOWER DEGREE OF LIGAND SUBSTITUTION.

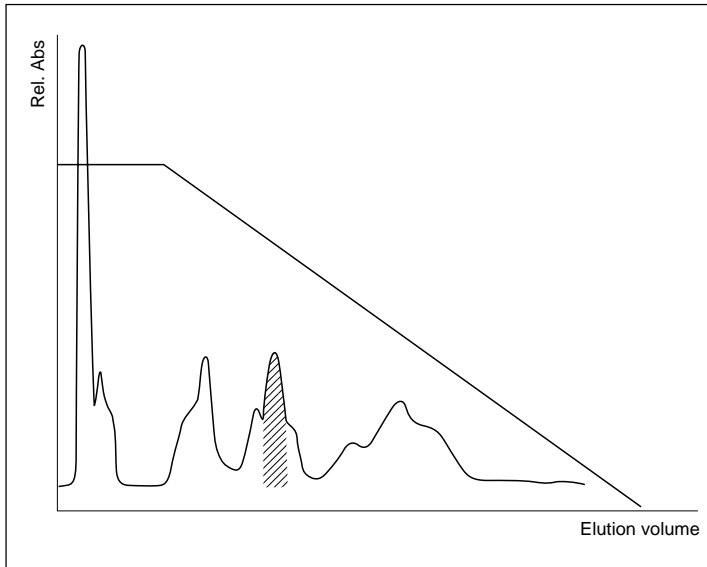

Fig. 15.

Result: Product is eluted in the middle of the gradient. Resolution is satisfactory.

Discussion: The choice of ligand is very good and there is less risk of strong binding of the most hydrophobic contaminants.

Next step: Continue with method development as outlined under “Optimizing a HIC step”.

The examples presented above do not cover two extreme cases that may arise, i.e. the situation in which the protein of interest is either not bound to the HIC medium or that it binds so strongly that it is difficult to elute it without using denaturing solvents. In both instances, one should try to use a different HIC medium or use another medium which operates on a different separation principle.

In some of the examples above it is assumed that resolution is inadequate. The requirements for resolution in any particular chromatographic step must be stipulated on a case-by-case basis. What sometimes seems to be fairly bad resolution can often be good enough if it is an initial capture step where the main objective is reduction of volume, removal of critical contaminants and preparation for higher resolution chromatography.

Optimizing a HIC step

The main purpose of optimizing a chromatographic step is to reach the pre-defined purity level with highest possible recovery by choosing the most suitable combination of the critical chromatographic parameters. In process applications there is also a need to reach the highest possible throughput. The screening experiments outlined previously will mainly help in establishing the most suitable medium to use. The sections below will deal with some important guidelines for optimizing the critical operational parameters which affect the maximum utilization of the HIC step. These parameters include: type of buffer salt, salt concentration, buffer pH, temperature, bed height, flow rate, gradient shape and gradient slope.

The solute

As in other adsorption chromatography techniques, the way HIC is used depends on the size of the solute molecule.

Small molecules such as small peptides interact with the medium by single point attachment. Their migration velocity depends directly on the binding constant of a single bond and can vary over a wide interval depending on the ionic strength of the mobile phase. Larger molecules such as proteins and nucleic acids interact with the medium by multi-point attachment. Their migration velocity depends on the sum of several bonds. Thus their velocity is extremely low at all ionic strengths over a certain value. The protein is more or less stuck to the column. Below this ionic strength, the protein is practically not retarded at all (47).

The interval of eluting strength where a large molecule is partly retarded on the column is thus much smaller than for a small molecule. This means that purifying large molecules on HIC is a typical on-off technique where the difference in retention for the molecules to be separated can be substantial at any specific ionic strength. In other words, separation of large molecules on HIC is a high selectivity technique. The separation should be optimized by manipulating the parameters affecting the selectivity of the system, i.e. optimizing the chemistry of the system by means of salt concentration, type of salt, pH, gradient slopes or stepwise elution schemes. By effecting relatively small changes in selectivity, large changes in resolution can occur.

When purifying small molecules on the other hand, the selectivity of the system is usually much lower and the requirements for purity might not be met by working on the selectivity alone.

The efficiency parameters such as bed height, bead size, theoretical plates, linear flow rate and sample volume may also have to be optimized.

In this handbook however, the focus will be on large molecules such as proteins and large peptides.

In conclusion, when purifying large molecules such as proteins, relatively short columns can be used if the selectivity of the adsorbent is exploited in an optimal way. The linear flow rate should, if required, be sufficiently reduced in order to optimize the kinetics of the adsorption and desorption process. This can also be further enhanced by choosing a smaller bead size. Smaller beads will also provide the necessary increase in efficiency when more difficult separation problems are encountered.

The solvent

This is one of the most important parameters to have a significant influence on the binding capacity and selectivity of a HIC medium. In general, the adsorption process is often more selective than the desorption process and it is therefore important to optimize the starting “binding” buffer conditions with respect to critical parameters such as pH, type of salt, concentration of salt and temperature. The combination of salt and pH can be manipulated to give optimum selectivity during purification by HIC. Optimal conditions differ from application to application and are best established by running linear gradients and varying the parameters in a controlled way (for example by using Factorial design). Changes of temperature and pH are sometimes restricted by the stability of the substance of interest or by system constraints etc. but may often be of interest to evaluate. The Hofmeister series (Table 1) gives important guidelines in choosing the type of salt to use. The most efficient salts are normally ammonium sulphate and sodium sulphate but also “weaker” salts such as sodium chloride should be considered. In an ideal situation, the correct choice of salt and salt concentration will result in the selective binding of the protein of interest while the majority of the impurities pass through the column unretarded. If the protein of interest binds weakly to the column, an alternative approach is to choose the starting buffer conditions which will result in the maximum binding of a large proportion of the contaminating proteins but allowing the protein of interest to pass through unretarded. An extension of this strategy is to increase the salt concentration in the unbound fraction to such an extent that the protein of interest binds to the same column in a second run while most of the impurities pass through the column unretarded.

The effect of varying the concentration of salt in the binding buffer on the purification of a monoclonal antibody (IgG₁) from mouse ascites fluid is shown in Fig. 16. The column of Alkyl Superose was equilibrated with varying concentrations of ammonium sulphate (2 M to 0.8 M) and its selectivity for the IgG₁ investigated. The results show that high selectivity for IgG₁ is obtained using 1 M ammonium sulphate in the binding buffer.

It should be pointed out that the higher the salt concentration in the equilibration buffer, the greater the risk that some of the proteins in the sample will precipitate. Since such precipitates can clog tubings and column filters, the sample must be filtered or centrifuged. This extra step can be avoided by equilibrating the sample in a lower salt concentration than is required for its precipitation and then applying it to a column which is equilibrated with a higher salt concentration (48). Some of the proteins will precipitate on the column (zone precipitation) but they redissolve upon reduction of the salt concentration during stepwise or gradient elution.

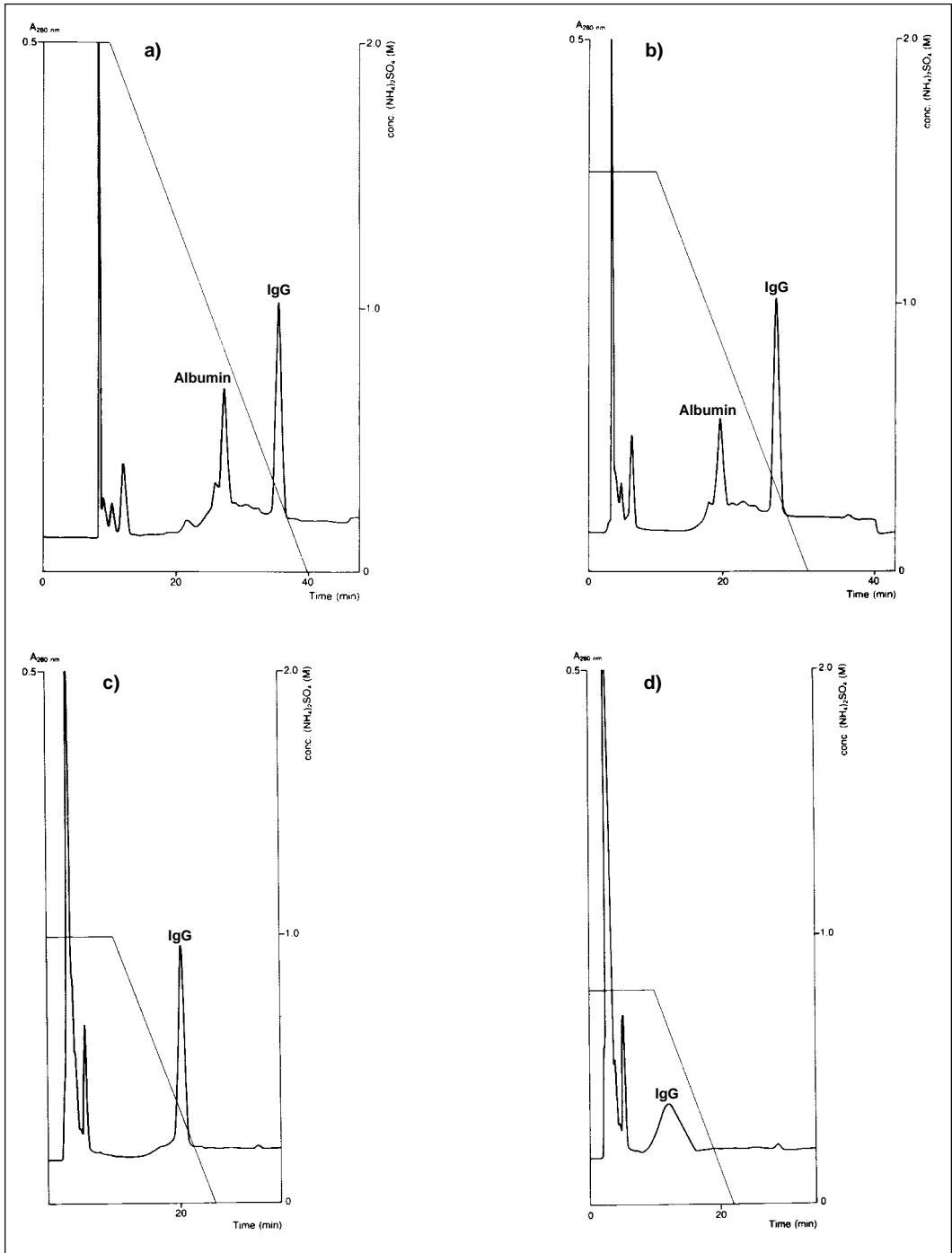

Fig. 16. The effect of starting conditions in HIC. Sample, 100 μ l anti-CEA MAB (-Ig₁) from mouse ascites fluid in 0.8 M (NH₄)₂SO₄ (corresponding to 20 μ l ascites); column, Alkyl Superose HR 5/5; flow rate, 0.5 min⁻¹; buffer A, 0.1 M sodium phosphate, pH 7.0, (NH₄)₂SO₄. (a) Sample applied in 2 M (NH₄)₂SO₄: both albumin and IgG are absorbed. (b) Sample applied in 1.5 M (NH₄)₂SO₄: less albumin binds and IgG elutes earlier in the gradient. (c) Sample applied in 1.0 M (NH₄)₂SO₄: albumin does not bind and, therefore, the column has a greater capacity for binding IgG. (d) Sample applied in 0.8 M (NH₄)₂SO₄: albumin does not bind; IgG is retarded, but elutes in a broad peak. (Work from Amersham Pharmacia Biotech, Uppsala, Sweden).

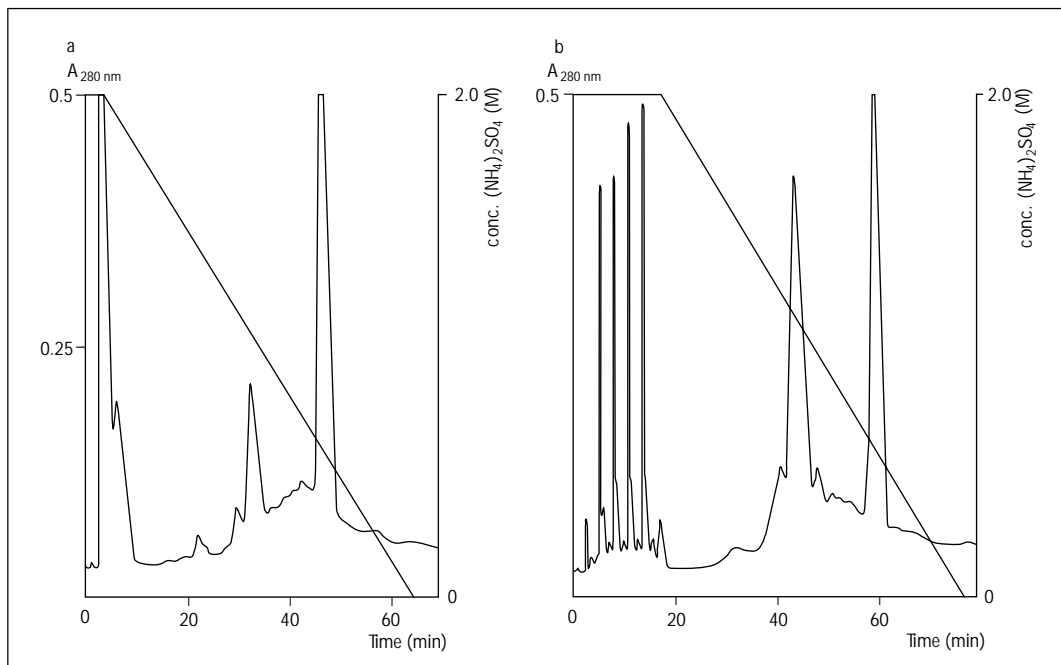

Fig. 17. The effect of loading conditions in HIC. Column, Alkyl Superose HR 5/5; flow rate, 0.5 ml min^{-1} ; buffer A, 0.1 M sodium phosphate, $\text{pH } 7.0$, $2 \text{ M } (\text{NH}_4)_2\text{SO}_4$. (a) Sample ($500 \mu\text{l}$ anti-CEA MAB (IgG_1) from mouse ascites fluid in $0.9 \text{ M } (\text{NH}_4)_2\text{SO}_4$ (corresponding to $115 \mu\text{l}$ ascites) applied in one injection. (b) Sample as (a) applied in five $100 \mu\text{l}$ injections with $1.3 \text{ ml } 2.0 \text{ M } (\text{NH}_4)_2\text{SO}_4$ after each portion. (Work from Amersham Pharmacia Biotech, Uppsala, Sweden).

When sample is applied at a salt concentration lower than that used for equilibration of the column, the sample volume becomes important. This is demonstrated in Fig. 17. When a $500 \mu\text{l}$ sample of ascites fluid was applied to a 1 ml column of Alkyl Superose, albumin, the weakest interacting substance, started to elute during sample application (Fig. 17 a). Dividing the sample into portions, e.g. five $100 \mu\text{l}$ samples and adding equilibration buffer (1.3 ml) after each sample application to enhance the hydrophobic interaction prevented early elution of albumin (Fig. 17 b).

Elution

This can be achieved by:

- i. A linear or step-wise decrease of the concentration of salt.
- ii. Adding various proportions of organic solvents to the elution buffer (see Chapter 2) provided that the protein of interest is stable upon exposure to such solvents. These additives decrease the polarity or surface tension of the eluent resulting in a reduction in the binding strength and the elution of the bound proteins from the column. Usually, 40% ethylene glycol or 30% iso-propanol, dissolved in salt-free buffer, is used. In some applications, it can be advantageous to linearly increase the concentration of such additives as the salt concentration of the elution buffer is simultaneously decreased by a linear gradient. The latter procedure can sometimes lead to increased resolution of the bound proteins.

- iii. Adding neutral detergents (usually 1%) to the elution buffer. However, some detergents are bound so strongly that they are difficult to wash out completely with common organic solvents (e.g. ethanol). In the worst case, this might lead to a decrease in the capacity of the HIC medium for subsequent applications. These additives must therefore be used with care.

The preferred method of elution is a linear or step-wise decrease of the salt concentration in the elution buffer. Some typical examples are presented below.

Gradient elution

Simple linear gradients are the first choice for screening experiments, but when more experience is at hand it might be advantageous to make a gradient more shallow in areas where resolution is inadequate. Consequently, areas where resolution is good can be covered by a steep gradient (Fig. 18). Such complex gradients offer maximum flexibility in terms of combining resolution with speed during the same separation.

By increasing the total gradient volume (i.e. decreasing gradient slope) of a linear gradient, resolution will be improved in all parts of the chromatogram (Fig. 19). This is usually not the best approach in preparative mode where the prime issue is not to resolve as many peaks as possible but to separate the compound of interest from the rest of the compounds in the feed material. Increased gradient volume will also give increased cycle time and the separated fractions will also be more diluted.

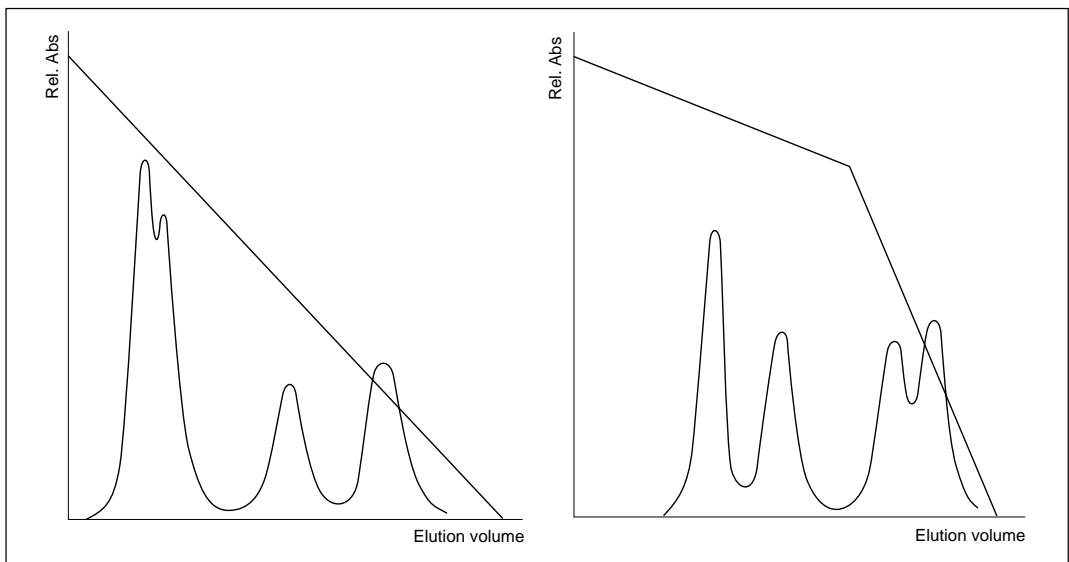

Fig. 18. Effect of a complex gradient on resolution.

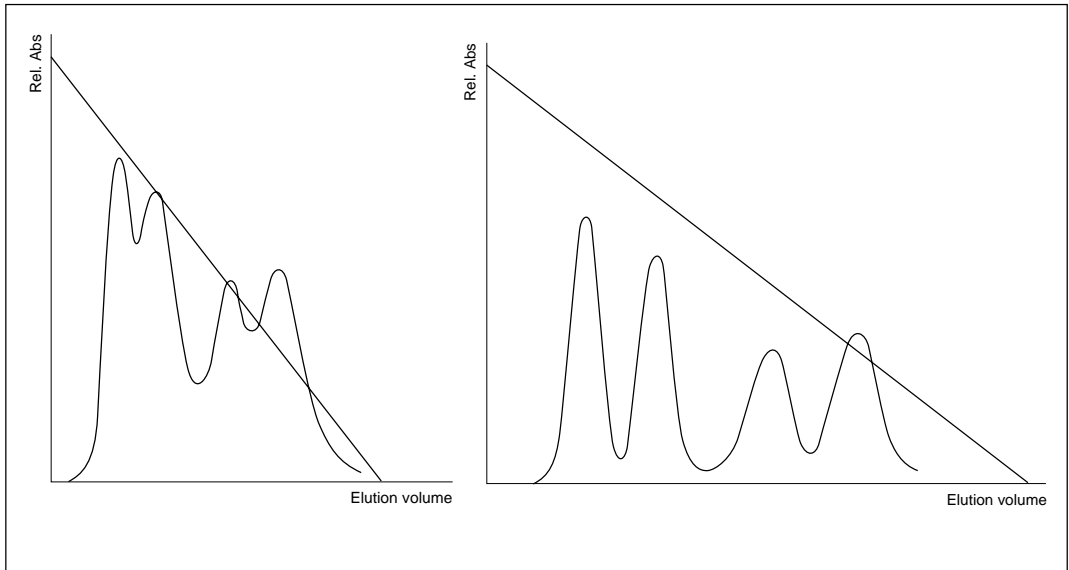

Fig. 19. Effect of gradient slope on resolution.

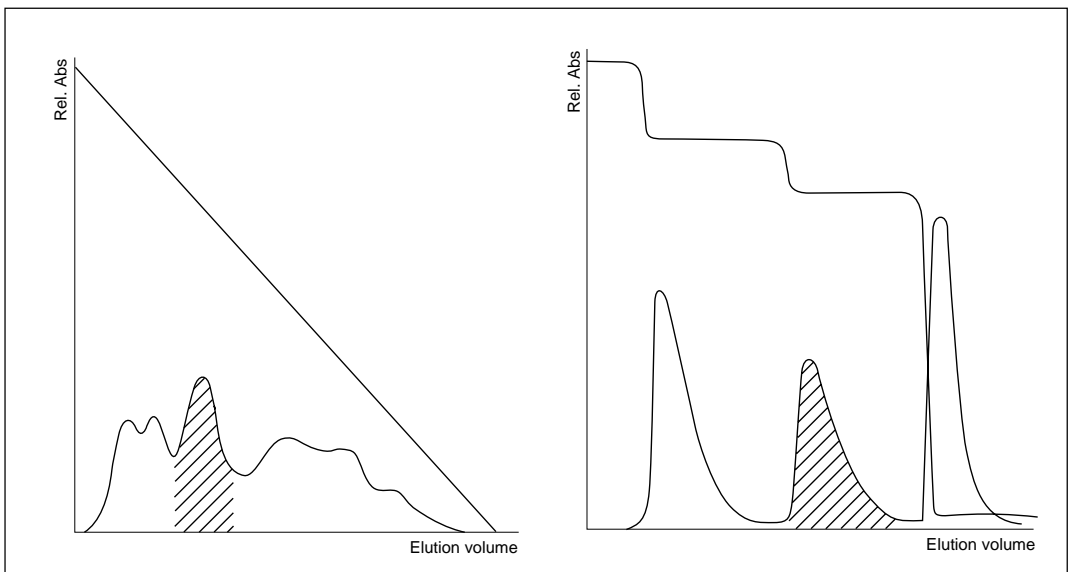

Fig. 20. Switching from a continuous gradient to step-wise elution.

Step-wise elution

Step-wise elution is often preferred in large scale preparative applications since it is technically more simple and reproducible than gradient elution.

Step-wise elution can sometimes be advantageous also in small scale applications since the compound of interest can be eluted in a more concentrated form if the eluting strength of the buffer can be kept high enough without causing co-elution of more strongly bound compounds.

The principle of step-wise elution is to increase resolution in the area where the peak of interest elutes. Fig. 20 illustrates how a three step increase in eluting strength can be used to obtain maximum resolution of the fraction of interest (shaded peak).

In the first step, the strength and the volume of the elution buffer is optimized to elute all compounds binding less strongly to the gel than the compound of interest. The elution strength and volume of buffer should be large enough to elute these contaminating weaker binding substances, but it must not exceed that level where the peak of interest starts to co-elute with the contaminating compounds.

In the second step the elution strength is increased to the point where the compound of interest elutes. The elution strength should be large enough to elute the compound of interest without excessive dilution, but must be kept below the level where the more strongly bound contaminating compounds start to co-elute.

In the final step, the elution strength is further increased to elute all of the remaining contaminating compounds. This step can be a very short one with high elution strength.

When step-wise elution is applied, one has to keep in mind the danger of getting artefact peaks when a subsequent step is administered too early after a tailing peak. For this reason it is recommended to use continuous gradients in the initial experiments to characterize the sample and its chromatographic behaviour.

Sample load and flow rate

The through-put of the method can be increased by increasing sample load and flow rate. However, this has to be traded off against decreased resolution (efficiency). The effects of sample load and flow rate are further discussed below under “Process considerations”.

Regeneration

After each cycle, bound substances must be washed out from the column to restore the original function of the medium. HIC adsorbents can normally be regenerated by washing with distilled water after each run. To prevent a slow build up of contaminants on the column over time, more rigorous cleaning protocols may have to be applied on a regular basis. (See page 63, “Cleaning, sanitization and sterilization procedures”).

Process considerations

In contrast to analytical chromatography or small scale preparative chromatography in research and development, process chromatography is used as part of a manufacturing process. Method development work has to focus on purifying the product of interest to the highest yield and the required purity as quickly, cheaply and easily as possible, i. e. to find the conditions that give the highest possible productivity (amount of product produced per volume of media and unit time) and process economy.

Method optimization in process chromatography

Firstly, selectivity for the substance of interest is maximized by choosing the proper type of media, pH, type of salt, salt concentration and temperature, as has already been outlined above.

In HIC, as for most other adsorption techniques, there are then basically two alternative routes to follow:

- i. If HIC is used in an intermediate or final step where the need for resolution is high in order to meet purity requirements for the final product, the resolution is maximized by working on the eluting conditions such as gradient shape, gradient slope or concentration and volume of steps in a step-wise elution procedure. Resolution should be the highest possible while still keeping separation time reasonably short and avoiding excessive dilution of eluted product. From this point, flow rate and sample load are optimized to find highest possible productivity where resolution is still high enough to meet the predefined purity requirements.

In HIC, as in ion exchange chromatography, sample load, flow rate and gradient volume are interrelated. Increased flow rate will give a decrease in resolution, but this decrease will not be very significant at high sample loadings. This means that under process conditions, where maximum sample load is applied to achieve maximum throughput, the flow rate is limited primarily by the rigidity of chromatography media and by system constraints. The effect on resolution of increased gradient volume is usually more significant than the effect of flow rate. This means that when increasing gradient volume to increase resolution, flow rate can also be increased accordingly to compensate for loss in separation speed. The result is an increase in resolution that may be traded off for increased sample loading and thereby increased productivity.

In other words, in process chromatography the best result will be obtained by using the maximum flow with the gradient volume that provides the best resolution, which is demonstrated in Fig. 21 for a model experiment on Phenyl Sepharose High Performance.

The flow rate in each experiment is shown in the bottom square. The largest increase in resolution was seen when going diagonally from A to C, i.e. increasing gradient volume at a constant flow rate. Even when going from AD to BC, i.e. increasing gradient volume and flow rate in the same order and thereby keeping a

Fig. 21.
The effect of gradient volume
and flow rate on resolution and
cycle time. (Work from
Amersham Pharmacia Biotech,
Uppsala, Sweden.)

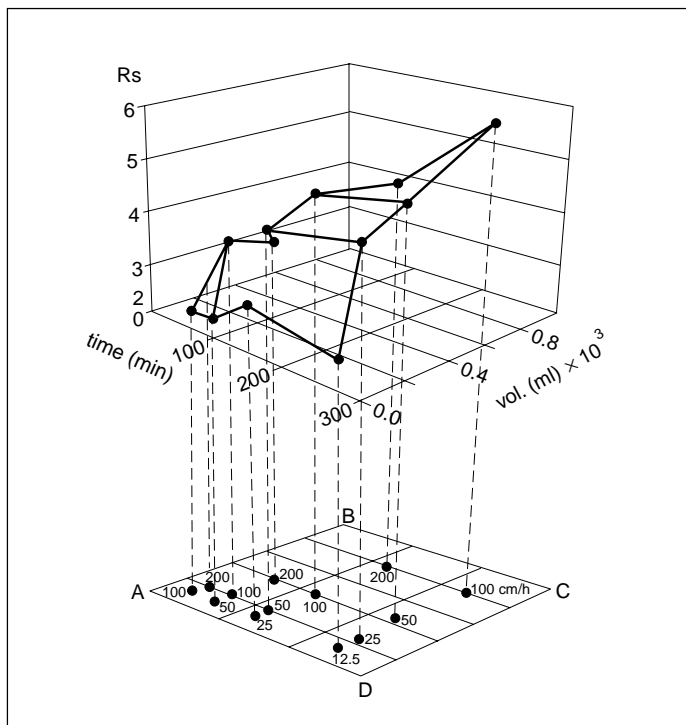

constant separation time, an increase in resolution could be observed. Going diagonally from D to B, i.e. increasing the gradient volume 2-fold while increasing the flow rate 4-fold, demonstrates how the separation time can be cut without losing resolution. As the resolution increases with increased gradient volume, however, dilution of each peak occurs, which also has to be taken into consideration.

- ii. If HIC, on the other hand, is used as an initial product capture step where the major concern is to remove critical contaminants and reduce volume, selectivity during desorption is not a prime issue.

After having washed out the non-bound substances, the compound of interest is eluted with a single-step procedure.

In this mode, the entire bed volume is utilized for sample binding and the prime consideration when optimizing for highest possible productivity is to find the highest possible sample load over the shortest possible sample application time with acceptable loss in yield. In this situation, more emphasis should be given to the binding strength of the compound of interest than to selectivity during sample application. This means that the salt concentration during sample application should not be too low since this will have a negative effect on dynamic binding capacity. Note also that less hydrophobic contaminating substances will not have any dramatic effect on the binding capacity for the compound of interest since they will be displaced by the latter.

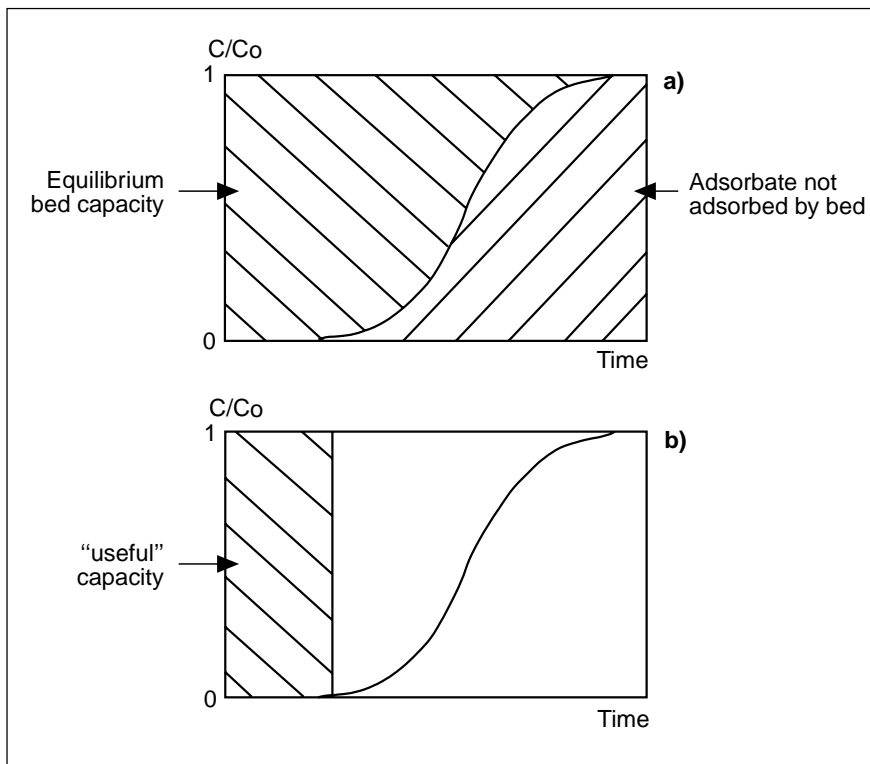

Fig. 22. Breakthrough curves for determination of dynamic capacity.

The dynamic binding capacity for the protein of interest should be determined by frontal analysis using real process feedstock. PAGE, ELISA or other appropriate techniques are used for the determination of the breakthrough profile of the actual protein (Fig. 22).

The curve in Fig. 22 a) and b) shows the ratio of the concentration of product at the outlet of the bed (C) to the concentration of product at the inlet (C_0) as more and more sample is applied to the column.

When the ratio has risen to 1, the bed is at equilibrium with the inlet stream and no further adsorption occurs.

Fig. 22 a) Here the equilibrium bed capacity is reached only after a considerable amount of adsorbate has passed through the bed without being adsorbed.

Fig. 22 b) This shows the “useful” binding capacity of the bed if the loading is terminated when breakthrough of the protein of interest is detected. The actual loading capacity may have to be reduced even further to compensate for the unbound fraction still being present in the void volume of the column when breakthrough is detected.

Since the dynamic capacity of a chromatographic adsorbent is a function of the linear flow rate used during sample application, sample loading capacity must be checked at different flow rates to reveal the optimum level that gives highest productivity without excessive leakage of product at the column outlet.

Significant increase in flow rate during sample application will always give a decrease in dynamic binding capacity. Even if dynamic capacity will be significantly lower at a higher flow rate it can still be advantageous from a productivity point of view to use a higher flow rate.

To process a specific batch size, the process can be run in a cycling mode with a lower sample loading at a higher flow rate. The lower sample loading capacity per cycle may be compensated for by the decrease in cycle time caused by decreased sample volume and increased flow rate. The usefulness of this approach depends on how many cycles have to be run for a specific batch size and on how large the sample application time is in relation to the rest of the cycle time.

Scaleability

Scaling-up a chromatographic process is discussed in Chapter 5, “Experimental Technique”. Scaling-up is usually not a major concern if scaleability has been considered from the very beginning and built into the process during the method development stage.

One important aspect of scaleability common to all types of chromatography is selection of chromatographic media. Important properties of media that should be considered during the initial media screening phase are physical and chemical stability.

Physical stability (rigidity) is important in reaching the same high flow rates in the large production column as were achieved in the small column during method development. When column diameter is increased, the support from the column wall is decreased and if the media are not rigid enough bed compression will occur. This compression will increase back pressure and reduce flow rate.

Chemical stability of the media is important for applying efficient regeneration, cleaning-in-place and sanitization-in-place protocols. Cleaning and sanitization are a vital part of any chromatographic process. They assure product integrity and maximize media life time. Often harsh chemicals, e.g. 1 M NaOH, are used in such procedures and the chromatographic media have to withstand exposure to such conditions without their chromatographic properties being adversely affected. Recommendations for cleaning, sanitization, and sterilization procedures are given in Chapter 5, “Experimental Technique”.

Another aspect of media selection and scaleability is bead size. Smaller beads give less peak broadening (higher efficiency) due to decreased diffusion distances (reducing non-equilibrium zone broadening) and decrease of eddy diffusion. However, smaller beads also give increased backpressure and more problems with fouling of the chromatographic bed, especially when crude feed material is applied to the column in the first chromatographic step.

As has been discussed earlier, HIC is a high selectivity technique where efficiency usually is of minor importance for the resolution achieved. In consequence, a moderate bead size (e.g. 90 μm) should always be used in initial steps. In intermediate and final steps, smaller beads (e.g. 34 μm) can be used if requirements for resolution cannot be met by selectivity alone.

In addition, the type of salt used, salt concentration and gradient volume are all important aspects of scalability which have to be considered early in the method development stage.

Different types of salt, as well as the amount of salt consumed in the process, offer different degrees of environmental and waste disposal problems, and will also affect the overall cost of the process. Such problems can be overcome by minimizing initial salt concentration as discussed earlier in this chapter under “Choice of HIC media” and “Optimizing a HIC step”. The effect of excessive gradient volumes on the consumption of salt should also be considered.

The waste water treatment cost varies between different countries but according to Swedish conditions, where legislation in this area is very rigorous, the cost for ammonium sulphate (1 M) is approximately 300 USD per 1000 l and for sodium sulphate (1 M) approximately 200 USD per 1000 l (December 1992). Sodium chloride (4 M) has to be diluted 50 times before it can be fed into the municipal sewage system.

Regulatory considerations

Regulatory considerations are often as critical to the successful development and implementation of a chromatographic process as the purification scheme itself. This is particularly true when producing biologicals to be used as therapeutics. Licensing authorities look upon chromatography media as raw material used in the process. New batches of chromatography media have to be placed in quarantine and can be released for production only when they have been tested and found to be in compliance with established acceptance criteria. Generally, identity tests also have to be performed on each new lot to be brought into production.

When selecting media for development of a production process, it is therefore of utmost importance that documentation needed to set up analytical test procedures is available from the media vendor. Part of the testing needed for acceptance of new batches of media, such as particle size distribution, total capacity, flow properties and microbial contamination, is normally provided by the vendor through a Certificate of Analysis. Some of the tests may have to be repeated as part of the acceptance routines at the production site and analytical methods and identity tests provided by the vendor can then be of great help.

Besides the documentation needed for setting up acceptance criteria, extensive documentation about the chemical stability of the medium is also needed to define optimal conditions for regeneration, cleaning, sanitization and storage.

Another important aspect that has to be investigated during process development is whether any extractable compounds or leakage products from the medium can be potential contaminants in the end product. To be able to test for absence of such compounds, information should be available from the vendor on possible extractable compounds and leakage products and on the kind of methods to use to quantify these compounds in the column eluate. In this connection, it must be made clear that there is no such thing as “leakage-free” chromatography media. Whether leakage in the eluent stream will be detected or not is solely a question of the detection limit of the analytical method used. The leakage levels in product stream that may be accepted by different licensing authorities will be stipulated on a case-by-case basis depending on the application area of the final product, the form of administration, the life time dosage and the toxicity of the leakage product.

A regulatory concern specific for HIC is the different additives such as chaotropic substances, organic solvents and detergents that can be used to modulate the separation behaviour. Such additives also may have to be proved absent from the final product.

Experimental Technique

Choice of column

The material of a chromatographic column should be chosen to prevent denaturation of labile biological substances and minimize non-specific binding to exposed surfaces. The nets or frits used to retain the media should be easily exchangeable to restore column performance whenever contamination and/or blockage in the column occurs.

It is also important that all dead volumes, i.e. the volume of the distribution system and tubing, is kept to a minimum to prevent band spreading through dilution or re-mixing.

The pressure specification of the column has to match the back pressure generated in the packed bed when run at optimal flow rate. This is particularly important when using high performance media with small bead sizes.

Amersham Pharmacia Biotech has developed a series of standard laboratory chromatography columns (XK columns) suitable for HIC. Further information on the full range of laboratory chromatography columns can be found in the Amersham Pharmacia Biotech catalogue which is available upon request.

Column dimensions

As for most adsorptive, high selectivity techniques, HIC is normally carried out in short columns. A typical HIC column is packed to a bed height of 5-15 cm. Once the separation parameters have been determined, scale-up is easily achieved by increasing the column diameter.

Packing the column

As with any other chromatographic technique, packing is a very important step in a HIC experiment. A poorly packed column gives rise to poor and uneven flow, zone broadening, and loss of resolution. Packing a HIC column with a modern, highly cross-linked agarose-based gel such as Sepharose Fast Flow is however easier than packing a gel filtration column since the bed height required is much smaller.

Packing Sepharose Fast Flow based HIC gels

Preparation of the gel

The gel is supplied pre-swollen in 20% ethanol. Prepare a slurry by decanting the 20% ethanol solution and replace it with packing solution in a ratio of 50–70% settled gel to 50–30% packing solution. The packing solution should not contain agents which significantly increase the viscosity. Distilled water or a low ionic strength buffer are suitable packing solutions.

Packing

1. Equilibrate all materials to the temperature at which the chromatography will be performed.
2. De-gas the gel slurry to minimize the risk of air bubbles in the packed bed.
3. Eliminate air from the column dead spaces by flushing the end pieces with packing solution (or 20% ethanol). Make sure no air has been trapped under the column net. Close the column outlet. Leave a few centimeters of packing solution remaining in the column.
4. Pour the slurry into the column in one continuous motion. Pouring the slurry down a glass rod held against the wall of the column will minimize the introduction of air bubbles.
5. Immediately fill the remainder of the column with packing solution, mount the column top piece onto the column and connect the column to a pump.
6. Open the bottom outlet of the column and set the pump to run at the desired flow rate. Ideally, Sepharose 6 Fast Flow matrices are packed at a constant pressure of 0.15 MPa (1.5 bar) and Sepharose 4 Fast Flow matrices at a constant pressure of 0.10 MPa (1.0 bar). If the packing equipment does not include a pressure gauge, use a packing flow rate of 400 cm/h (15 cm bed height, 25°C, low viscosity buffer). If the recommended pressure or flow rate cannot be obtained, use the maximum flow rate the pump can deliver. This should also give a reasonably well-packed bed.

Note: Do not exceed 70% of the packing flow rate in subsequent chromatographic procedures.

7. Maintain the packing flow rate for 3 bed volumes after a constant bed height is reached.
8. After packing is completed, the level of the packed bed is marked on the column tube before the pump is stopped. Next, the outlet is closed, the pump is stopped and the inlet tubing is disconnected from the pump. Then the adaptor O-ring is slackened and the adaptor is lowered down until it reaches the surface of the packed bed. The O-ring is then tightened sufficiently for the adaptor to slide when pushed. Finally, the adaptor is lowered down until it is 3 mm below the mark on the column tube.

Packing Phenyl Sepharose High Performance

Preparation of the gel

The gel is prepared in the same way as has been described previously for Sepharose Fast Flow based HIC gels.

Packing

Sepharose High Performance media are packed by a two-step technique using a low settling flow rate in the first step and then compressing the bed with a high constant back pressure in the second step.

STEP 1: Pack with a flow rate of 10–30 cm/h for 20–60 min or until the packed bed has reached a constant height.

STEP 2: Lower the adaptor to approximately 1 cm above the surface of the bed. Increase the flow rate until a pressure of 5.0 bar is reached and maintain this pressure for 30–60 minutes.

Points 1–5 and point 8 in the packing instruction for Sepharose Fast Flow based HIC gels also apply to the packing of Sepharose High Performance based gels.

Note: There could be some resistance from the packed bed when pushing the adaptor down the last 3 mm, but it is important to fix the adaptor at this level. The packing procedure described above has been developed for the XK 16 and XK 26 columns.

Packing Sepharose CL-4B based HIC gels

Sepharose CL-4B based HIC gels are packed using a procedure similar to the method for Sepharose Fast Flow media.

The maximum flow rate for a laboratory scale column with an internal diameter of up to 5 cm and a bed height of up to 15 cm is 150 cm/h. Do not exceed a maximum back pressure of 0.04 MPa (0.4 bar).

Use of an adaptor

If an adaptor has not been used during column packing it should be fitted as follows:

1. After the gel has been packed as described above, close the column outlet and remove the top piece from the column. Carefully fill the rest of the column with buffer to form an upward meniscus at the top.
2. Slacken the adaptor tightening mechanism and insert the adaptor at an angle into the column, ensuring that no air is trapped under the net.

3. Adjust the tightening mechanism to give a sliding seal between the column wall and the O-ring. Screw the adaptor end-piece on to the column.
4. Make all tubing connections at this stage. There must be a bubble-free liquid connection between the column and the pump and the column and the sample application system.
5. Slide the plunger slowly down the column so that the air above the net and in the capillary tubing is displaced by eluent. Valves on the inlet side of the column should be turned in all directions during this step to ensure that all air is removed.
6. Lock the adaptor in position with the tightening mechanism, open the column outlet and start the eluent flow. Pass eluent through the column at the packing flow rate until the gel bed is stable.
7. Mark the column tube at the level of the packed bed before the pump is stopped.
8. Close the outlet, stop the pump and disconnect the inlet tubing from the pump.
9. Slacken the adaptor O-ring and push the adaptor down until it reaches the surface of the packed bed.
10. Tighten the O-ring so the adaptor is still able to slide and push the adaptor down until it is 3–5 mm below the mark on the column tube.

Checking the packed bed

Testing the bed is easily done by injecting a test substance on the column and calculating the number of theoretical plates (N) or the height equivalent to a theoretical plate (HETP).

Choose a test substance which shows no interaction with the media and which has a low molecular weight to give full access to the interior of the beads.

Acetone at a concentration of 1% (v/v) can be used with all kinds of chromatographic media and is easily detected by UV-absorption. Keep the sample volume small to have a narrow zone when the sample enters the top of the column. For optimal results, the sample volume should be - 0.5% of the column volume for a column packed with a medium of approximately 30 µm bead diameter, and - 2% of the column volume for a column packed with a medium of approximately 100 µm bead diameter. Keep the linear flow rate low to reduce that part of the zone spreading which is an effect of non-equilibrium at the front and rear of the zone. For 30 µm media the flow rate should be between 30–60 cm/h and for 100 µm media, 15–30 cm/h. Use the following equations to calculate the number of theoretical plates (N) and HETP.

$$N = 5.54 \left(\frac{V_e}{W_{1/2}} \right)^2 \quad \text{HETP} = \frac{L}{N}$$

where,

V_e is the volume eluted from the start of sample application to the peak maximum and $W_{1/2}$ is the peak width measured as the width of the recorded peak at half of the peak height (see Fig. 23). L is the height of the packed bed.

Measurements of V_e and $W_{1/2}$ can be taken in distance (mm) or volume (ml). The plate count will be the same as the resulting ratio is dimensionless. The unit of measurement should be the most convenient available but both parameters must be expressed in the same units.

Fig. 23.

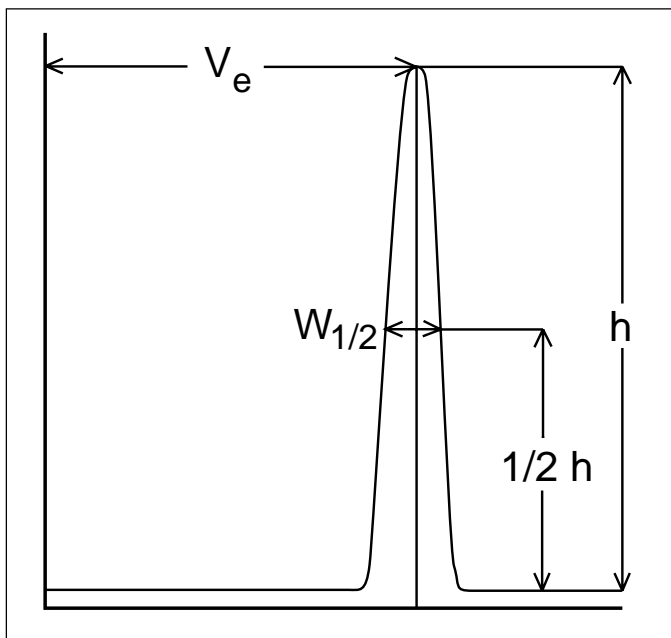

As a general rule of thumb, a good HETP value is about two to three times the mean bead diameter of the gel being packed. For a $90 \mu\text{m}$ particle packing, this means an HETP value of 0.018–0.027 cm.

Another useful parameter for testing the packed bed is the Asymmetry factor (A_p).

$$A_f = \frac{b}{a}$$

where,

a = 1st half peak width at 10% of peak height

b = 2nd half peak width at 10% at peak height (see Fig. 24)

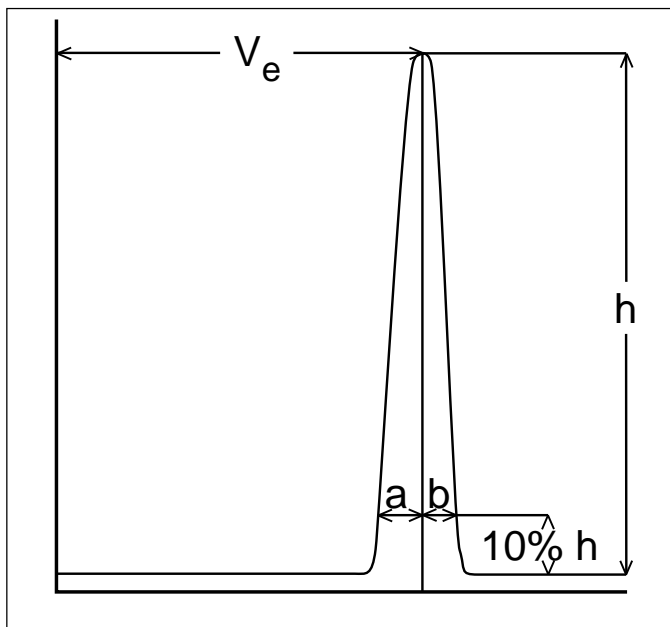

Fig. 24.

A_f should be as close as possible to 1. A reasonable A_f value for a short column such as a HIC column is 0.80–1.80. (For longer gel filtration columns it will probably fall within 0.70–1.30).

An extensive leading edge is usually a sign of the gel being packed too tightly and extensive tailing is usually a sign of the gel being packed too loosely.

Prepacked HIC Media

Sepharose High Performance and Superose based HIC media are available in prepacked HiLoad, HR or PC columns. (See Product Guide, Chapter 3).

After connecting the column to the chromatography system, column preparation simply consists of washing out the 20% ethanol solution with start buffer and bringing the column to equilibrium.

Details of the installation and use of these columns are available in their respective instructions.

Sample preparation

Sample composition

HIC requires a minimum of sample preparation work. Since adsorption is carried out at high salt concentration, it is not necessary to change the buffer of a sample before applying it to a HIC column. The only action to be taken is to add sufficient salt and adjust the pH if necessary to ensure that the component of interest binds.

If the salt is added in solid form, some precipitation may occur due to high local salt concentration. This can be avoided if the salt is added as a high concentration stock solution. If chaotropic agents such as guanidine hydrochloride and urea are present in the start material, they have to be removed prior to sample application since their influence on binding to the HIC medium will be opposite to that of the salt used for promoting hydrophobic interaction.

Sometimes lipids or other very hydrophobic substances are present in the sample. These may interact very strongly with a HIC column, blocking capacity and being very difficult to remove from the column after the purification cycle. In such cases, using a slightly less hydrophobic column as a pre-column can prove to be very efficient in removing such substances before the sample enters the actual chromatographic column. The pre-column should be chosen to bind the most hydrophobic material and allow the substance of interest to pass through under equilibration conditions.

Sample volume

HIC is an adsorption technique and starting conditions are normally chosen so that all important substances are adsorbed at the top of the bed. As such, sample mass applied is of far greater importance than the sample volume. This means that large volumes of dilute solutions, such as cell culture supernatants, can be applied directly to a HIC column without prior concentration. HIC thus serves as a useful means of concentrating a sample, in addition to fractionating it.

However, sample volume becomes important when the salt concentration in the sample is lower than in the buffer used for equilibration. This can be the case if the salt concentration in the sample has to be decreased to avoid precipitation as has been discussed in Chapter 4, “Experimental Design”. When a large sample volume is applied under such conditions, the weakest interacting substances may start to elute during sample application. This can be avoided by dividing the sample into portions and adding equilibration buffer between each sample application to enhance the hydrophobic interaction and prevent early elution (see Fig. 17).

Sample viscosity

The viscosity may limit the quantity of sample that can be applied to a column. A high sample viscosity causes instability of the zone and an irregular flow pattern. High viscosity can also create problems with high back pressure, in particular if the medium used has a small bead size, e.g. 10 or 34 μm . A rule of thumb is to use 4 cP (centipoise) as the maximum sample viscosity. This corresponds to a protein concentration of approximately 5% in water. Approximate relative viscosities can be quickly estimated by comparing emptying times from a pipette.

If the sample is too viscous due to high solute concentration, it can be diluted with start buffer. High viscosity due to nucleic acid contaminants can be alleviated by precipitation by forming an aggregate with a poly-cationic macromolecule such as polyethyleneimine or protamine sulphate. Nucleic acid viscosity can also be reduced by digestion with endonucleases. Such additives may however be less attractive in an industrial process since they will have to be proven absent from the final product.

Particle content

In all forms of chromatography, good resolution and maximum column life time depend on the sample being free from particulate matter. It is important that “dirty” samples are cleaned by filtration or centrifugation before being applied to the column. This requirement is particularly crucial when working with small particle media, e.g. 10 or 34 μm bead size.

The filter required for sample preparation depends on the particle size of the HIC matrix which will be used. Samples to be separated on a 90 μm medium can be filtered using a 1 μm filter. For 34 μm and 10 μm media, samples should be filtered through a 0.45 μm filter. When sterile filtration or extra clean samples are required, a 0.22 μm filter is appropriate.

Samples should be clear after filtration and free from visible contamination. If turbid solutions are injected onto the column, the column lifetime, resolution and capacity can be reduced. Centrifugation at 10 000 g for 15 minutes can also be used to prepare samples. This is not the ideal method of sample preparation but may be appropriate if samples are of very small volume or adsorb non-specifically to filters.

Sample application

Sample reservoir (Fig. 25)

Samples can be applied by connecting a sample reservoir (e.g. RK or R) to the valves LV-3 and LV-4 or SRV-3 and SRV-4. With this method, the sample is allowed to run onto the column by gravity. Small samples can be applied via a syringe using the valve as a syringe holder.

Sample applicators (Fig. 26)

Sample applicators SA-5 and SA-50 are reservoirs which, when used in combination with a suitable valve e.g. SRV-4, allow the sample to be applied via a closed sample loop system using a pump. Sample can be introduced into the sample applicator as a layer below the eluent using a syringe and needle. As well as their large capacity (up to 5 ml for the SA-5 and 45 ml for the SA-50) the sample applicator offers the additional advantage of serving as a bubble trap.

Fig. 25.
Sample application using a reservoir.

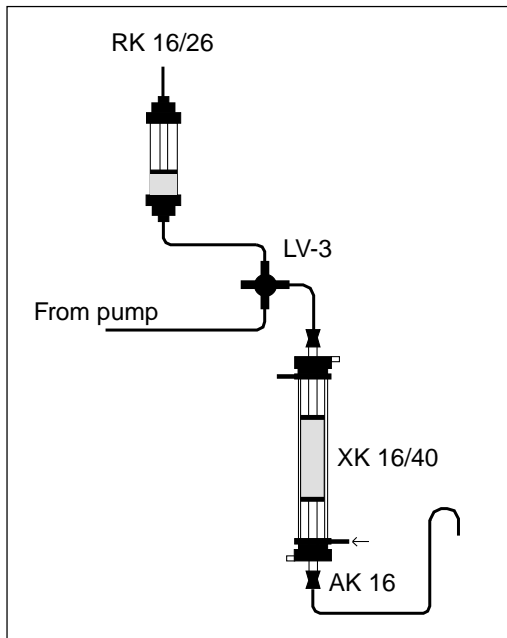
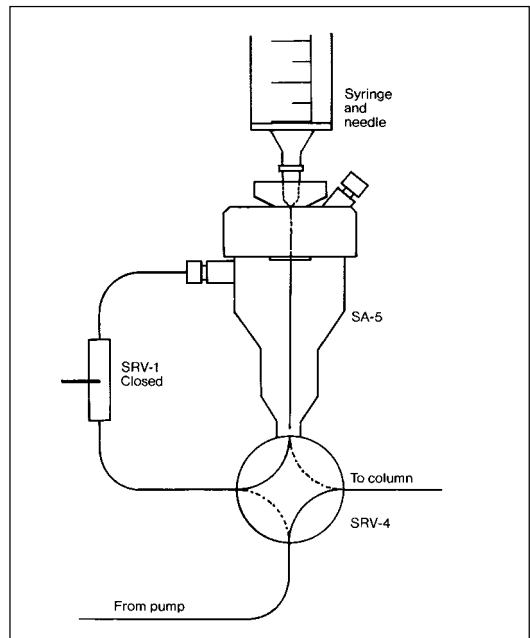

Fig. 26.
Sample application using a SA-5 in a sample loop system.



Sample loops with valves LV-4 or SRV-4 (Fig. 27)

This method is convenient for applying small samples. By using the same sample loop, very reproducible sample volumes can be applied, although exact knowledge of the applied volume requires calibration of the capillary tubing loop.

Sample loops or Superloop with valves V-7 or MV-7 (Fig. 28).

This method is used for sample application when using high performance columns and other columns in FPLC System or BioPilot™ System. Superloop is a unique sample application device from which a sample of any volume up to the capacity of the Superloop (10, 50 or 150 ml) can be applied to a column without tailing. A movable seal separates the sample from the eluent. As eluent is pumped into the Superloop, the sample moves ahead of the seal and onto the column. When nearly all the sample has been applied, eluent flows round the seal to wash the remainder of the sample quantitatively onto the column. Superloop should be used for applying sample volumes larger than 1 ml.

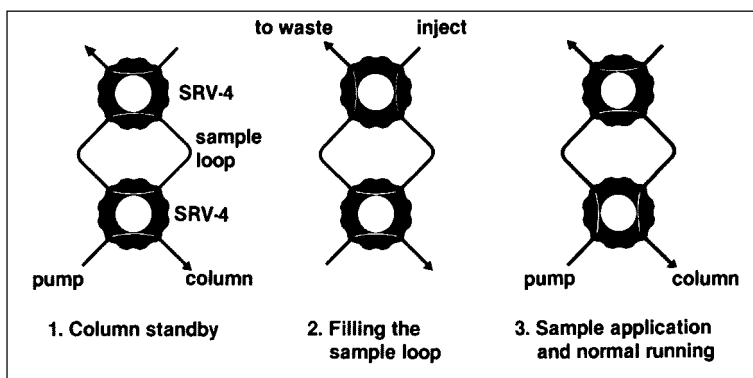

Fig. 27. Sample application with a sample loop and two SRV-4 valves.

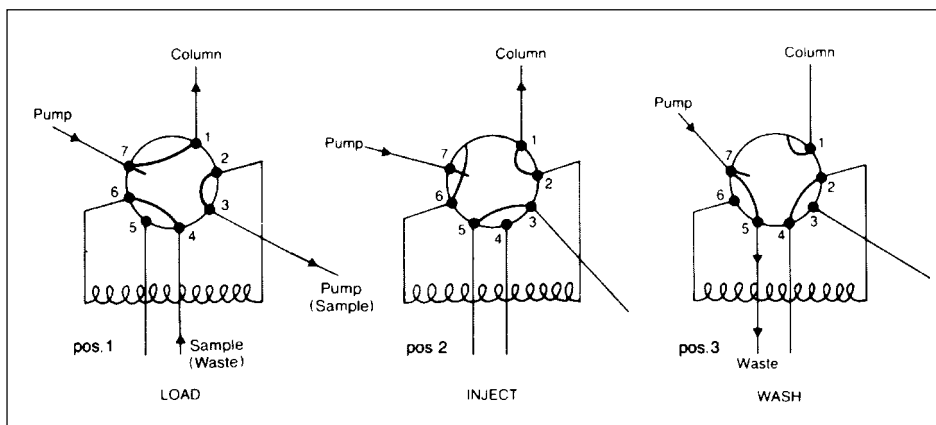

Fig. 28. Seven-port valves, V-7 and MV-7 have three operating positions which make sample application and changing eluents particularly convenient.

Batch separation

For an initial capturing step on a HIC medium in process scale, a batch separation procedure can sometimes be worthwhile considering instead of a more traditional column separation procedure. Although the resolution of batch separation is lower than in column chromatography, it may offer advantages in particular cases. When very large sample volumes with low protein concentration have to be processed, the sample application time on a column can be very long and filtration of such a large sample can also be rather difficult to perform. Binding the sample in batch mode will be much quicker and there will be no need to remove particulate matter.

A batch procedure can also be an attractive approach if high sample viscosity generates high back pressure in a column procedure or if high back pressure is generated by contaminants such as lipids which may cause severe fouling and clogging of the column.

When working with HIC in batch mode starting conditions should be selected in the same way as in column chromatography, i.e. to bind the substance of interest but to prevent as many contaminants as possible from binding.

When starting conditions have been selected, the amount of adsorbent needed and the time to reach equilibrium should be determined at small scale in a beaker.

Adsorbent is added to the sample and stirred until binding is complete. The gel slurry should not be stirred too rigorously since this will generate fines. Then the gel is allowed to settle and filtered by suction until the adsorbent is damp but not dry. The sedimented adsorbent is washed with buffer to remove non-adsorbed unwanted material. Then elution buffer is added (1–2 times the volume of the sedimented gel) and stirred until desorption is complete, which can take up to 30 minutes or more. Finally, suction is used to filter the buffer containing the desolved product of interest from the adsorbent. The gel can also be packed in a column after the washing step and be eluted stepwise in the same way as during normal column chromatography. Resolution will however be lower for such a combined batch and column procedure compared with a normal column procedure, since the sample is bound uniformly throughout the gel slurry and the subsequent chromatographic bed.

At process scale, the complete procedure of adsorption, washing and desorption is most conveniently carried out in a batch application tank equipped with a stirrer and an outlet with a filter at the bottom of the tank.

Cleaning, sanitization and sterilization procedures

Cleaning-in-place (CIP) is the removal from the purification system of very tightly bound, precipitated or denatured substances generated in previous purification cycles. In some applications, substances such as lipids or denatured proteins may remain in the column bed instead being eluted by the regeneration procedure. If such contaminants

accumulate on the column for a number of purification cycles, they may affect the chromatographic properties of the column. If the fouling is severe, it may also block the column, increasing back pressure and reducing flow rate.

A specific CIP protocol should be designed according to the type of contaminants that are known to be present in the feed stream.

NaOH is a very efficient cleaning agent that can be used for solubilizing irreversibly precipitated protein and lipid material and in HIC it can be effectively combined with solvent or detergent based cleaning methods.

Sanitization is the inactivation of microbial populations. When a packed column is washed with a sanitizing agent, the risk of contaminating the purified product with viable microorganisms is reduced. The most commonly used sanitization method in chromatography today is to wash the column with NaOH. NaOH has a very good sanitizing effect and also has the additional advantage of cleaning the column.

Sterilization, which is not synonymous with sanitization, is the destruction or elimination of all forms of microbial life in the system.

Suggested protocols for cleaning-in-place (CIP), sanitization-in-place (SIP) and sterilization that can be applied to the full range of HIC products outlined in Chapter 3, “Product Guide”, are summarized in Table 12.

The CIP protocols should be used as guidelines to formulate a cleaning protocol specific for the raw material to be applied. The frequency of use will depend on the raw material applied to the column but it is recommended to use a CIP procedure at least every 5 cycles during normal use. Depending on the nature of the contaminants, different protocols may have to be used in combination. If fouling is severe the protocols may have to be further optimized. During CIP the flow direction through the column should be reversed.

Table 12. Suggested CIP, SIP and sterilization protocols for HIC media from Amersham Pharmacia Biotech.

Purpose	Procedure
<i>Removal of precipitated proteins</i>	4 bed volumes of 0.5 –1.0 M NaOH at 40 cm/h followed by 2–3 bed volumes of water
<i>Removal of strongly bound hydrophobic proteins, lipoproteins and lipids</i>	4–10 bed volumes of up to 70% ethanol or 30% isopropanol followed by 3–4 bed volumes of water. (Removal of 20% ethanol from Phenyl Sepharose Fast Flow (high sub) is shown in Fig. 29)
	or
	1–2 bed volumes of 0.5% non-ionic detergent (e.g. in 1 M acetic acid) followed by 5 bed volumes of 70% ethanol, to remove the detergent, and 3–4 bed volumes of water
<i>Sanitization</i>	0.5–1.0 M NaOH with a contact time of 30–60 min
<i>Sterilization</i>	autoclave the medium at 120°C for 20 min.

Note: Detergents should be used with care since they work as displacers and may sometimes bind so hard to the gel that it affects the binding capacity during subsequent purification cycles.

Fig. 29. Removal of 20% ethanol from Phenyl Sepharose 6 Fast Flow (high sub) in an HR 10/10 Column, bed volume 8 ml; mobile phase H₂O; flow rate 1 ml/min. (Work from Amersham Pharmacia Biotech, Uppsala, Sweden).

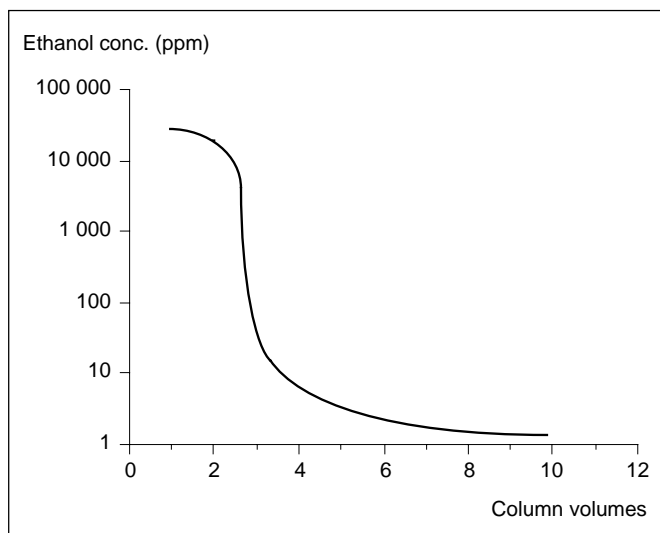

Storage of gels and columns

Prevention of microbial growth

Steps should always be taken to prevent bacterial growth in columns during storage. Microbial growth can seriously interfere with the chromatographic properties of the column and contaminate the purified product with microorganisms and endotoxins or other pyrogenic material. During storage, an antimicrobial agent should always be added to the chromatographic media. Antimicrobial agents may be eluted from columns before chromatographic runs or they may be present in the eluent during chromatography. Antimicrobial agents which interact with sample substances must be avoided if they are to be used in eluents, otherwise any agent which does not interact with the gel may be used. Some of the more commonly used antimicrobial agents are described below.

Antimicrobial agents

Sodium hydroxide

Sodium hydroxide, 0.01 M, is an effective bacteriostatic agent and is, besides 20% ethanol, the main recommendation for storage of HIC media from Amersham Pharmacia Biotech. At higher concentrations (0.5–1.0 M) it is an effective sanitizer for contaminated columns. For the most frequent contaminants in chromatographic systems, such as gram-negative bacteria, a good bactericidal effect is reached even at such low concentrations as 0.01 M NaOH.

NaOH is a widely accepted agent for maintaining chromatographic columns and systems since it not only gives efficient sanitization but also effectively destroys endotoxin (LPS) and solubilizes precipitated and denatured substances that have accumulated on the column. An additional advantage is the lack of toxicity as a contaminant in the end product.

Ethanol 20%

Chromatography media from Amersham Pharmacia Biotech are supplied as a suspension containing 20% ethanol. 20% ethanol can also be used as an alternative to NaOH for storing chromatography media under bacteriostatic conditions.

Chlorhexidine

Chlorhexidine (e.g. Hibitane™) is a very efficient bacteriostatic agent that inhibits the growth of many bacteria at a concentration of 0.002%. The effect against fungi is less pronounced, but the growth of many types can be inhibited by concentrations between 0.01% and 0.1%. Hibitane is incompatible with only a very few substances. Precipitation may occur on storage of Hibitane in solutions with appreciable concentrations of chloride or sulphate ions.

Phenyl mercuric salts ¹

Phenyl mercuric salts (acetate, nitrate, borate) are most efficient as bacteriostatics in weakly alkaline solutions. Concentrations recommended are from 0.001% to 0.01%.

Thimerosal ¹

Thimerosal (ethylmercuric thiosalicylate e.g. Merthiolate™) is a bacteriostatic most efficient in weakly acidic solutions. Concentrations recommended are from 0.005% to 0.01%. It is bound to and inactivated by substances containing thiol groups.

Trichlorobutanol

Trichlorobutanol (e.g. Chloretone™) is another bacteriostatic showing highest efficiency in weakly acidic solutions. Concentrations recommended are from 0.01% to 0.05%.

¹ The use of mercury containing antimicrobial agents is on the decline because of their toxicity. When used in a manufacturing process they may have to be proved absent in the end product.

Sodium azide

Sodium azide is a very widely used bacteriostatic agent giving a high bacteriostatic effect at a concentration of 0.02%–0.05%.

Note: The use of sodium azide is discouraged in many countries since it forms explosive insoluble salts with heavy metals and it is believed to be a mutagen.

Storage of unused media

Unused media should be stored in closed containers at a temperature of +4°C to +25°C. Note that it is important that the media are not allowed to freeze as the structure of the beads may be disrupted by ice crystals. This disruption will generate fines.

Storage of used media

Used media should be stored at a temperature of +4°C to +8°C in the presence of a suitable bacteriostatic agent, e.g. 0.01 M NaOH or 20% ethanol. Note that it is important that the media are not allowed to freeze as the structure of the beads may be disrupted by ice crystals. This disruption will generate fines.

Storage of packed columns

Packed columns should be stored at a temperature of +4°C to +8°C in the presence of a suitable bacterostatic agent, e.g. 0.01 M NaOH or 20% ethanol.

For long-term storage, the packed column should be thoroughly cleaned (CIP) before equilibration with the storage solution.

Recycling the storage solution through the column or flushing the column once a week with fresh storage solution is recommended to prevent bacterial growth.

Process considerations

Selecting a column

When a chromatographic step is being developed to be a part of a manufacturing process and the time has come for scaling-up, the next crucial step in ensuring a reliable product quality and maximum production economy is the decision about which column to use. Large scale columns offered by Amersham Pharmacia Biotech are described in the “Process Column Selection Guide”, which is available upon request.

Different demands are put on a column for production compared with one used for the initial R&D and scale-up experiments. Flexibility, which is needed in R&D and scale up, is achieved by using a column with a movable adaptor. In production, consistency in performance and safety of the end product are the main concerns. Here the column packing has to be reproducible, materials of construction have to be well characterised for leakage and the design mechanically stable.

A number of criteria have to be considered. These criteria are more dependent on the scale of operation than on the media and are thus very similar in their importance for HIC, ion exchange, gel filtration and affinity chromatography. Their ranking and importance change when moving through a chromatographic process (Fig. 30).

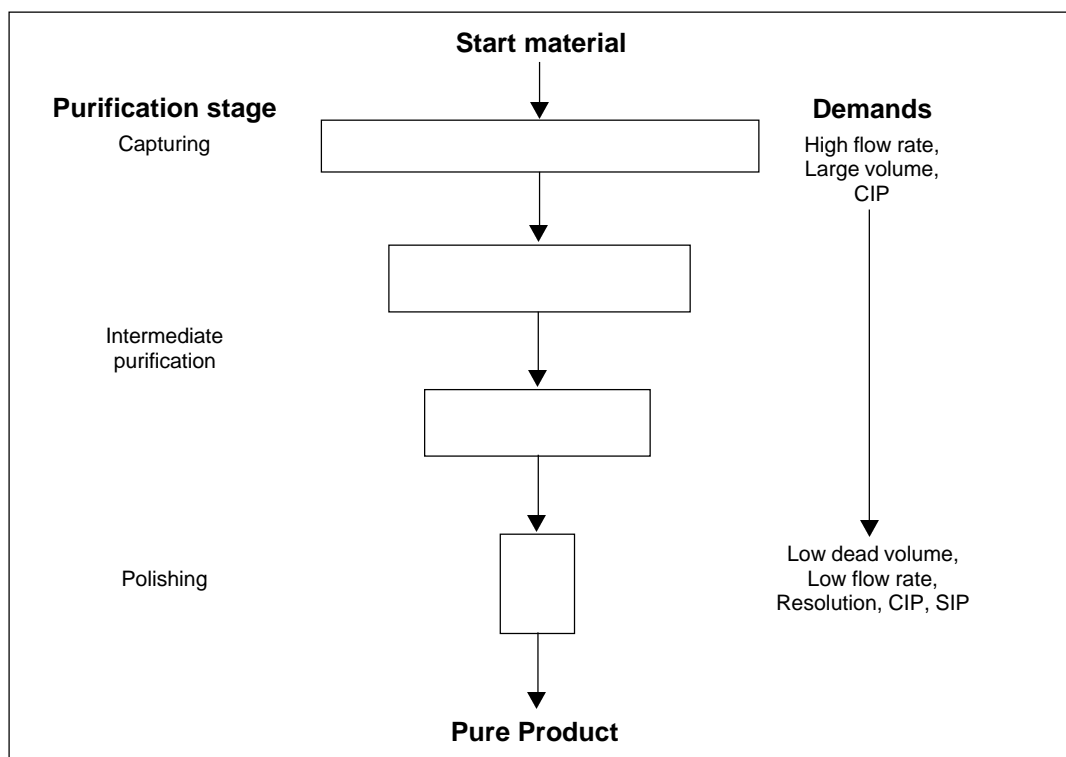

Fig. 30. In the initial capturing, handling large volumes at high flow rates is important. When moving towards the final steps, usually gel filtration, the demand for high resolution and thus low dead volume becomes more and more important. As noted earlier, HIC is mainly used for intermediate purification but can also be applied as an initial capturing step.

Aspects of column design

Flow distribution system

The single most important factor in process column construction is that the packed column will give a low and consistent HETP value of the same order as previously established in the small scale column during method development. To achieve this, the flow distribution system has to be designed to make flow distribution as even as possible at the column inlet and outlet.

Technically, the construction can vary but all columns showing an even flow distribution have a radial pressure drop that is negligible in relation to the axial pressure drop at the inlet (Fig. 31).

The simplest design to assist radial distribution consists of a coarse mesh net positioned between the column end piece and the finer mesh net retaining the bed. The coarse mesh net acts to provide channels for radial distribution. Single or multiple inlet/outlet ports are used depending on the column diameter.

Depth filters have a disadvantage compared with nets since the relatively large filter surface can become blocked due to adherence of molecules in the feed to the filter material. In continuous production situations, this drawback of depth filters might create serious problems.

Fig. 31.
Radial and axial back pressure in a column distribution system.

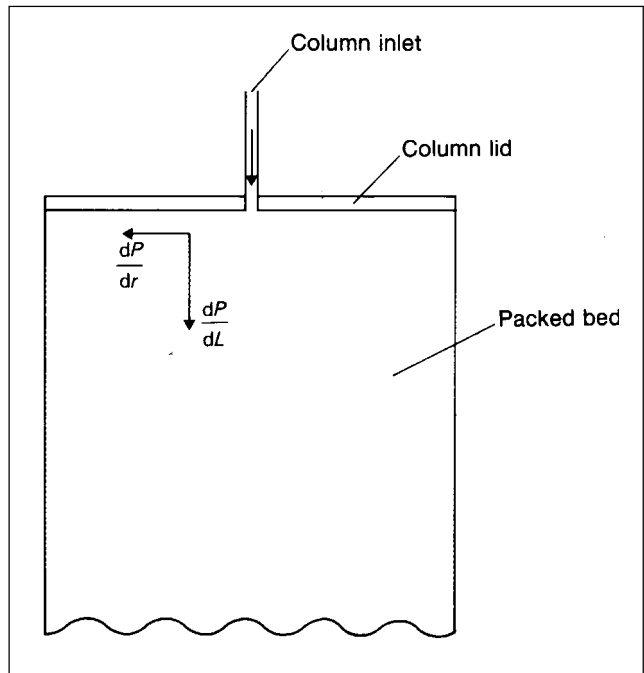

Material resistance and durability

Wetted components of the column must be constructed from materials having high chemical resistance towards harsh chemicals such as 1 M NaOH, which is frequently used in regular cleaning-in-place (CIP) and sanitization procedures.

Very large columns have to be constructed from stainless steel. Occasionally, a normal stainless steel column might not be compatible with some chemicals used. For example, even common NaCl buffers at mildly acidic conditions can cause corrosion problems. In this case a fluoroplastic coated stainless steel construction is recommended. When using a stainless steel column in a HIC step, it is exposed to high salt concentrations. The steel type ASTM 316 L (DIN 1.4435, SS 2353), which is normally used in stainless steel constructions, can stand 0.5 M NaCl but only if the pH is kept at pH 6 or above.

Sanitary design

The possibility of effectively cleaning and sanitizing a packed column also depends on the smoothness of the wetted surfaces. Smooth surfaces hinder bacterial attachment and facilitate cleaning. The total column design, including the absence of threaded fittings, is important in eliminating dead volume in the column. Minimizing dead volumes will minimize trapping and growth of microorganisms and thus facilitate cleaning and sanitization of all wetted parts of the column.

Columns constructed from calibrated borosilicate glass allow the use of thin O-rings in the adaptor end-plate, which gives a minimum of dead volume in the column. Borosilicate glass will also provide a smooth and durable surface, minimizing bacterial attachment and facilitating the cleaning of the column. A plastic column is usually less expensive, but most plastics do not meet pharmaceutical industry requirements for chemical resistance, hygienic design and in-line cleaning. They might, however, be well suited for scale-up experiments.

Pressure vessel safety

When working with HIC, the pressure is usually kept low i.e. about 1 bar, but the volumes handled and the size of a process column can mean that it should be regarded as a pressure vessel. The design has then to conform to local regulations to be approved for use. Also, to facilitate a final regulatory approval, the whole column has to be produced under strict documentation routines where materials used and modifications made can be traced.

Ergonomics

Finally, for easy handling of a process column, it becomes important to have a column which is constructed in a stable way, which is easy to pack and to keep clean. If the column has an adaptor, it should be easy to move and lock in its new position. Valves should be easy to reach and the whole column should be possible to take apart for cleaning. Keeping all the above factors in mind will facilitate choosing the correct column for the specified need.

Packing large scale columns

Column configuration

Process columns with a moveable adaptor are essentially packed in the same way as laboratory columns with adaptors. In essence, this means that the gel slurry is compressed by a flowing liquid until the bed height has stabilized, at which point the flow is stopped and the adaptor is lowered onto the gel surface and secured in place.

Large scale columns are, however, frequently supplied with fixed end pieces. This calls for a different packing technique. Some kind of extension tube has to be fitted on top of the column as a reservoir for the gel slurry. When the bed has been packed and settled at the join between the extension tube and the column, the extension tube is removed and the top column lid is secured in place.

Pressurized systems (pressure packing)

Columns with moveable adaptors are packed in a pressurized system with a constant packing flow rate or a constant packing pressure. If constant flow rate is used, the pressure drop over the column will increase during packing as result of increased flow restriction from the packed bed. If constant pressure is used, the flow rate will be high in the beginning but decrease during packing for the same reason as above. Moderately sized columns with fixed end pieces can also be packed in a pressurized system. For such columns, two column tubes are fitted together to store the complete slurry volume before packing is started. When the bed has settled at the join between the two tubes, the upper tube is emptied of liquid by suction through the packed bed. At this stage the system is no longer pressurized but the bed is still kept compressed in the lower column tube by the liquid flow during the suction phase. When the upper tube is emptied the flow is stopped, the tube is quickly removed and the top lid is put in place and secured.

Non-pressurized systems (suction packing)

Columns with fixed end pieces, such as the BioProcess Stainless Steel Columns from Amersham Pharmacia Biotech, are packed in a non-pressurized system by sucking packing solution through the column. Pressure packing of such columns would require very heavy packing tubes, which would be impractical to work with. In suction packing, the pump is connected to the column outlet and the excess packing solution in the gel slurry is pumped out at a predetermined flow rate. Immediately after the last part of the slurry has been sucked into the packed bed (when the surface starts to be dry), the flow is stopped, the packing device is quickly removed and the column lid is put in place and secured. Very simple packing devices can be used to store the gel slurry since the system is not pressurized.

More detailed packing instructions are to be found in the instruction manual accompanying each column.

Irrespective of the packing technique, the most important parameter for an optimally packed bed is the linear packing flow rate (velocity of flow through the column). In general, the higher the flow rate the better the performance of the packed bed, as long as the flow rate does not cause extensive bed compression, which can lead to channelling and an irregular flow pattern through the bed. Modern rigid media such as Sepharose Fast Flow and Sepharose High Performance withstand very high flow rates. In such cases, the pressure specification of the column rather than the separation medium, often sets the upper flow rate limit. However, with less rigidly cross-linked media such as Sepharose and Sepharose CL, the bed is often compressed and maximum flow rate reached, before the pressure limit of the column is reached. Irrespective of gel type, bed compression is more pronounced in large diameter columns since support given by the inner column wall to the gel bed is reduced. Since the optimum packing flow rate and pressure is dependent on gel type, gel batch, gel quantity, temperature, packing solution and equipment, it must be determined empirically for each individual system by establishing a pressure/flow curve for each specific column/gel set up.

A pressure/flow curve is established in the following way:

- 1) Prepare the column in exactly the same way as for column packing
- 2) Pump buffer through the column at a low flow rate (e.g. 30% of the expected maximum flow rate). Record the flow rate and pressure when the bed is packed and the pressure has stabilized.
- 3) Slowly increase the flow rate in small steps and record the flow rate and pressure at each step after the pressure has stabilized.
- 4) Continue to increase the flow rate like this until the flow rate levels off at a plateau, indicating bed compression, or until the pressure reaches the pressure specification of the column.
- 5) Plot pressure against flow rate as indicated in Fig. 32. The optimal packing flow rate is the maximum flow rate, i.e. where the flow rate starts levelling off on the pressure/flow curve. If no plateau is reached, use the flow rate at the maximum pressure specification of the column.

Alternatively, use a constant pressure packing technique where the packing pressure is the pressure where flow rate starts levelling off, or if no plateau is reached, the specified maximum pressure for the column used.

The packed column should not be run at more than 70% of the final flow rate reached during packing. This precaution prevents further bed compression when, for instance, a viscous sample is applied.

Fig. 32.
Establishing a
pressure/flow rate
curve.

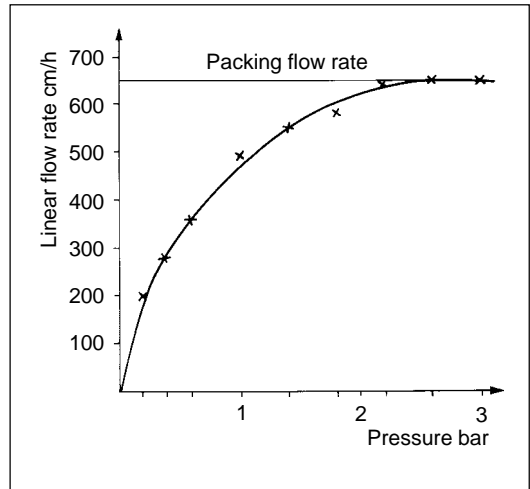

Packing buffer

The composition of the packing buffer can sometimes be critical for the performance of the packed bed. A packing solution frequently used is 0.1 M NaCl. For HIC media supplied by Amersham Pharmacia Biotech, water is equally effective.

Packing Sepharose CL and Sepharose Fast Flow based media

The first task when packing Sepharose CL and Sepharose Fast Flow based media in large scale columns is to determine the optimal packing flow rate (constant flow rate packing) or optimal packing pressure (constant pressure packing), by establishing a pressure/flow curve as outlined opposite.

For constant flow rate packing, the bed is packed by pumping packing solution through the column at the predetermined flow rate. The flow rate is checked at regular intervals and adjusted continuously since the increase in flow resistance from the packed bed will continuously reduce flow rate. The back pressure should be recorded with a manometer connected between the pump and the column to assure that maximum pressure for the gel or the column is not exceeded.

For a constant pressure packing technique, the packing solution is applied through the column at a constant pressure by using a pump and a manometer, or by using a pressure vessel, to deliver the flow through the column continuously at a preset back pressure.

The packing technique will differ in detail depending on which type of column is used. Detailed packing instructions for each type of column are included in the instruction manuals for large scale columns supplied by Amersham Pharmacia Biotech.

Packing Phenyl Sepharose High Performance in

Packing Phenyl Sepharose High Performance in BioProcess Glass Columns (BPG™) is performed with a two-step technique similar to that recommended for laboratory columns. The gel is packed with a low flow rate in the first step and then compressed with a high constant back pressure in the second step.

* **STEP 1:** Pack the gel at a constant flow rate of 20 cm/h for 60 minutes.

STEP 2: Lower the adaptor to approximately 1 cm above the surface of the bed. Increase the flow rate until a pressure of 3.0 bar is reached. Maintain this pressure for 30 minutes.

This packing technique has been developed to give maximum column efficiency and bed stability when packing Phenyl Sepharose High Performance in BPG Columns.

Scale-up

Once scalability has been considered from start and built into the process during the method development work (see Chapter 4, “Experimental design”), scaling up a chromatographic step is usually a straight-forward process.

One important aspect of scalability is the physical stability of the chromatography media. Scaling up to a larger diameter column means that most of the bed support from the friction against the column wall is lost. This loss can give increased bed compression and poorer flow/pressure characteristics. Using a highly cross-linked, rigid matrix during the method design work will ensure that the large scale column can be run at the same linear flow rate as the small scale column, without problems with increased back-pressure.

Another important aspect of scalability is the bead size. If a small bead (e.g. 10 µm) has been used during method development work in small scale, it is usually necessary to switch to a larger bead when scaling up to optimize throughput and reduce operating costs. In such cases, some re-optimization work has to be performed at the laboratory scale before the process can be scaled up.

* The recommendation for the first step is for BPG 100 and BPG 200 columns. For BPG 300 columns, a constant pressure of 0.5 bar should be applied for 30 minutes.

Some general guide-lines for scaling-up are outlined in Table 13.

Table 13. Scale up guidelines.

Maintain	Increase	Check system factors
Bed height	Sample load	Distribution system
Linear flow rate	Volumetric flow rate	Wall effects
Sample concentration	Column diameter	Extra column zone spreading
Gradient volume/bed volume		

Increasing the bed volume by increasing the column diameter and increasing volumetric flow and sample load accordingly, will ensure the same cycle time as in the laboratory scale method development. The column bed height, linear flow rate, sample concentration and ratio of sample to gel, all optimized on a laboratory scale, will be kept the same. If a gradient is used for elution, the ratio of gradient volume to bed volume will remain constant and, therefore, the time required for the gradient to develop and the effect on resolution, will remain the same on the larger column. The same principle is applied for the volume of each step in a step gradient.

Different system factors may affect performance after scale up. If the large scale column has a less efficient flow distribution system, peak broadening may occur due to increased axial dispersion in the bed and extra zone spreading in the end pieces. This will cause extra dilution of the product fraction or even loss of resolution.

Depending on the rigidity of the media, the loss of wall support in a large scale column will have a smaller or greater impact on bed compression, with accompanying deterioration of the flow/pressure properties of the packed bed. The effect of bed compression can be checked by running a pressure/flow rate curve such as outlined under “Packing large scale columns”.

Zone spreading can also be caused by non-column factors such as increased internal volumes of pumps, valves and monitoring cells and different lengths and diameters of pipes or tubing.

If all the above aspects of scaling up are taken into consideration, chromatographic variability is normally not a big issue when scaling-up.

Non-chromatographic factors may have a more significant effect on performance. These factors include: changes in sample composition and concentration that often occur as the fermentation scale increases, precipitation in the biological feedstock due to longer holding times when large volumes must be handled, non-reproducibility of the buffer quality due to inadequate equipment for consistently preparing large quantities of buffer solutions, and microbial growth in feed-stock or buffers due to increased handling and longer holding times.

The effects of these kinds of variabilities should be checked by challenging the chromatographic process during method development by running it under “worst-case” situations.

Applications

Preparative and analytical HIC applications in the research laboratory

HIC is widely used in protein purification in the research laboratory as a complement to other techniques that separate according to other parameters such as charge (ion exchange chromatography), size (gel filtration) or biospecific recognition (affinity chromatography). The outcome of a protein purification procedure is obviously dependent on the choice of separation equipment and techniques. The order in which the different techniques are combined is also of great importance. This chapter, emphasises different possibilities to combine HIC with other separation techniques in laboratory scale protein purification schemes. Analytical separations by HIC are also discussed.

HIC in combination with ammonium sulphate precipitation

When ammonium sulphate precipitation has been used early in a protein purification procedure to precipitate out contaminants, HIC is ideal as the next step. The protein of interest is present in the supernatant at a high ammonium sulphate concentration, and the sample can thus be directly applied to the HIC column. Purification occurs concomitant with a reduction in volume.

Crude purification of human autotaxin

HIC was used for initial purification of autotaxin, a human 125K protein which stimulates tumour cell motility (49). The supernatant from ammonium sulphate precipitation of concentrated cell culture medium was applied directly to a Phenyl Sepharose CL-4B column (Fig. 33). Elution was achieved with a double linear gradient with decreasing ammonium sulphate and increasing ethylene glycol. Autotaxin was then further purified to homogeneity using affinity chromatography, gel filtration and anion exchange chromatography.

Column: Phenyl Sepharose CL-4B, 200 ml
Sample: Supernatant from ammonium sulphate precipitation (1.2 M) of concentrated conditioned media (corresponding to 200 l of conditioned media) from A2058 melanoma cells
Buffer A: 50 mM Tris, pH 7.5, 5% (v/v) methanol, 1.2 M ammonium sulphate
Buffer B: 50 mM Tris, pH 7.5, 5% (v/v) methanol, 50% (v/v) ethylene glycol
Flow rate: 1 ml/min
Detection: A₂₈₀ (solid curve) and motility (circles).
 Chemotaxis was quantitated with a 2202 Ultrosan laser densitometer.

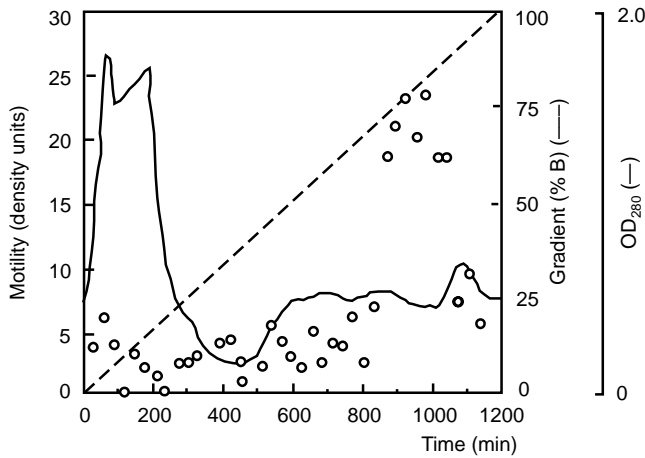

Fig. 33. HIC purification of human autotaxin from the supernatant from ammonium sulphate precipitation of conditioned melanoma cell culture medium (reproduced with permission, from ref. 49).

HIC in combination with ion exchange chromatography

HIC is often an excellent choice subsequent to ion exchange in a protein purification procedure. Both techniques have an extremely broad applicability, and are complementary (i.e. separation according to hydrophobicity and charge, respectively). Furthermore, material eluted with a salt gradient in an ion exchange separation requires a minimum of sample treatment before application to a HIC column. Usually sample treatment is limited to the addition of salt.

Purification of recombinant HIV reverse transcriptase

Recombinant HIV reverse transcriptase, expressed as a 66K/51K heterodimer in *E. coli*, was purified using a multi-step procedure involving ion exchange, ammonium sulphate precipitation and HIC (50). The second chromatography step was anion exchange with DEAE Sepharose CL-6B. Pooled active material was diluted with 3 M

Fig. 34. Purification of recombinant HIV reverse transcriptase, expressed in *E. coli*, using HIC (reproduced with permission, from ref. 50).

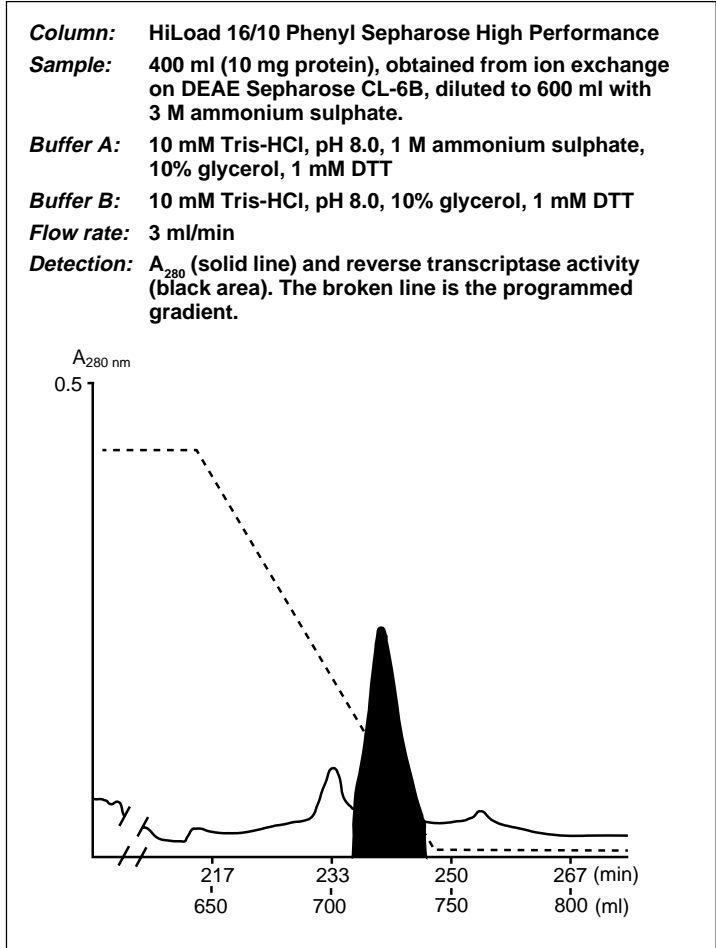

ammonium sulphate and applied to a column containing Phenyl Sepharose High Performance (Fig. 34). The HIC step was used both as a purification step and a concentration step and it reduced the volume 15 fold (from 600 to 40 ml). The final purification step was anion exchange with FPLC™ using a Mono Q™ column.

Purification of mammalian transcription factors

Transcription factors are present at extremely low levels in mammalian cell nuclei. A purification scheme was developed for µg amounts of six different transcription factors from an extract of 1012 HeLa cells (51). The complementary selectivities of HIC and ion exchange are well illustrated in this scheme. Transcription factors IIF and IIH co-purified in anion exchange (two different DEAE columns) and cation exchange (Phosphocellulose and Mono™ S), but were excellently separated on Phenyl Superose HR 10/10 (Fig. 35) with FPLC System. Further purification of the factors involved other chromatography steps. Final micropurification of transcription factor IIE was done on Phenyl Superose™ PC 1.6/5 with SMART™ System.

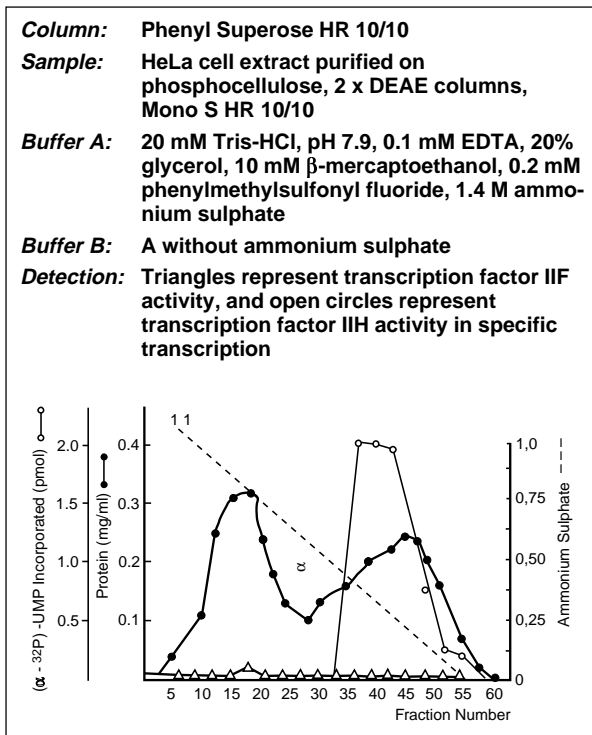

Fig. 35. HIC separation of mammalian transcription factors IIH and IIF (reproduced with permission, from ref. 51).

Micropurification of a GTPase activating protein

Final micropurification of a GTPase activating protein, GAP-3, from bovine brain was done with micropreparative columns for HIC and anion exchange chromatography (52). Prior purification steps were anion exchange chromatography, dye affinity chromatography, ammonium sulphate precipitation, gel filtration, hydroxyapatite, HIC and anion exchange. GAP-3 containing fractions from the latter step (Mono Q HR 5/5) were applied to the Phenyl Superose PC 1.6/5 column (Fig. 36). Active material from HIC was then applied to a second micropreparative column (Mono Q PC 1.6/5), and subjected to N-terminal sequence analysis. The overall recovery was 50 μ g GAP-3 from 1.6 kg of brain tissue, which corresponds to a purification factor of approximately 18000.

HIC in combination with gel filtration

A major advantage with adsorption chromatography is the possibility to achieve a decrease in sample volume concomitant with an increase in purity. In a purification scheme, HIC and other adsorption chromatography techniques are therefore frequently used prior to gel filtration, in which sample volume is limited.

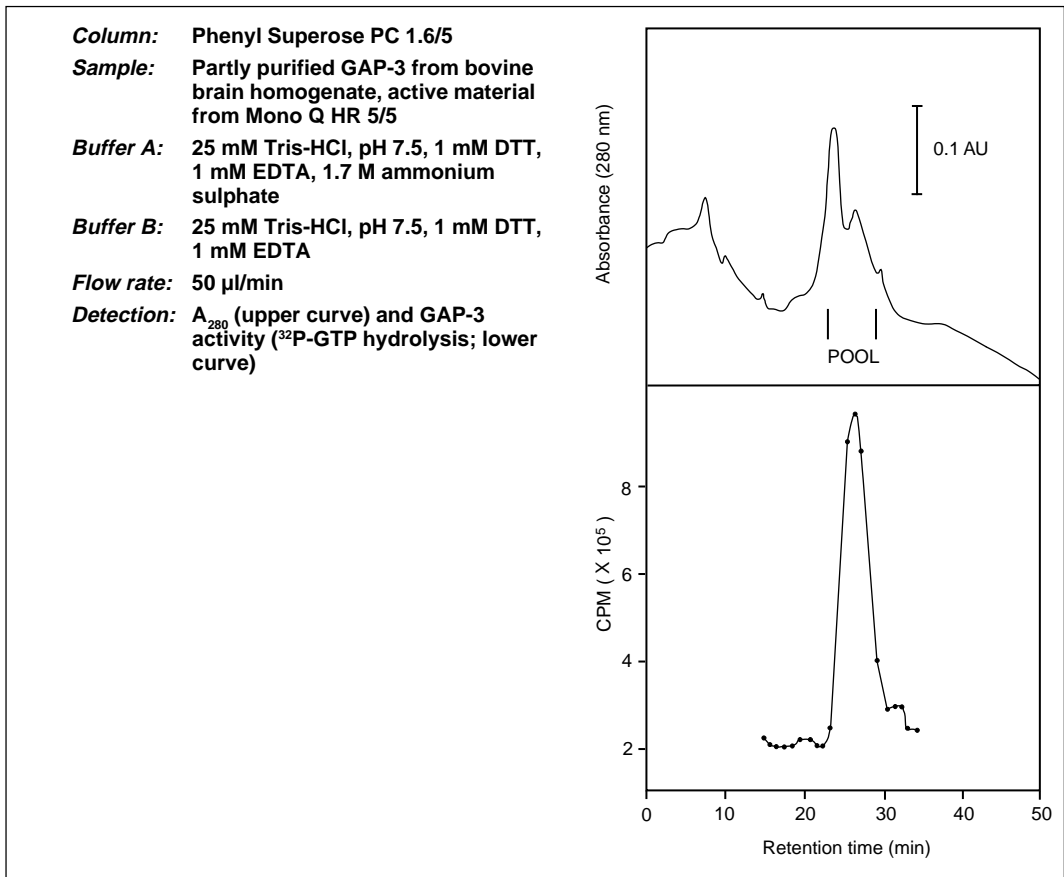

Fig. 36. Micropurification of GAP-3 (reproduced with permission, from ref. 52).

Human pituitary prolactin was purified on a Phenyl Sepharose CL-4B column (53) (Fig. 37). Elution was achieved stepwise, with 50% ethylene glycol. The sample volume was reduced in HIC from 300 ml to 45 ml, and the recovery of activity was 95%. The sample was applied to a gel filtration column (Sephadex G-100) for further purification.

HIC as a “single step” purification technique

In general, “single step” purification of a protein to homogeneity from a complex biological sample requires the use of highly specific affinity techniques. If general techniques are chosen, e.g. HIC, ion exchange and gel filtration, they usually have to be combined to obtain a homogeneous product. In some instances, however, a single chromatography step with a general technique may be sufficient to give a pure product.

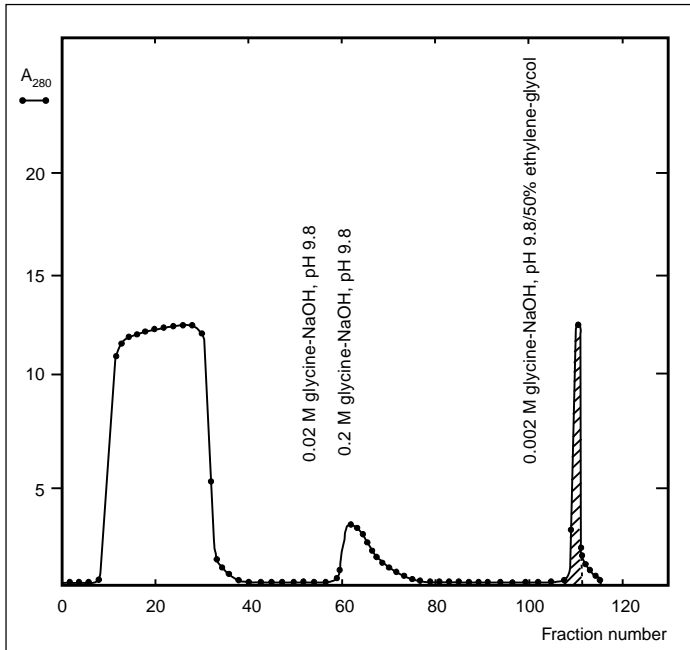
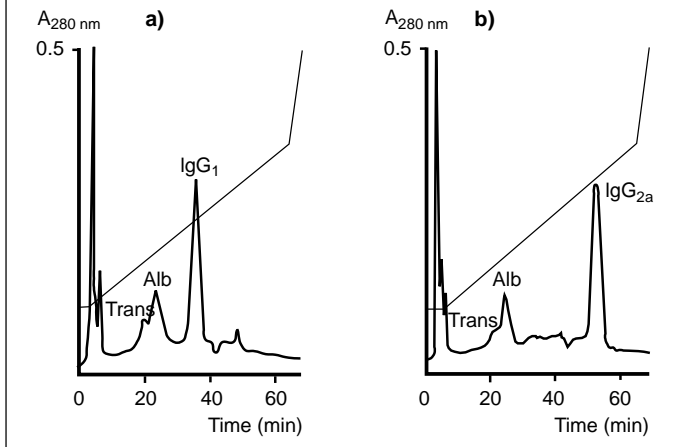

Fig. 37. Chromatography on Phenyl Sepharose CL-4B of a prolactin preparation. The hatched area represents the prolactin-containing fractions. (reproduced with permission, from ref. 53.)

Column: Alkyl Superose HR 5/5
Sample: 100 μ l mouse ascites containing monoclonal IgG₁ (a) or IgG_{2a} (b) + 100 μ l buffer A, centrifuged and filtered
Buffer A: 0.1 M phosphate, pH 7.0, 2.0 M ammonium sulphate
Buffer B: 0.1 M phosphate, pH 7.0
Detection: A_{280} . Proteins were identified by SDS-PAGE with PhastSystem. The programmed gradient (FPLC System) is also shown.

Fig. 38. "Single step" HIC purification of monoclonal antibodies from ascites. (Work by Amersham Pharmacia Biotech).



Column: Phenyl Sepharose High Performance, 5x10 mm.
Samples: a) 60 µg methylamine treated, inactive ("fast") α_2 -macroglobulin
 b) 60 µg active ("slow") α_2 -macroglobulin
 c) a + b
Buffer A: 20 mM sodium phosphate, pH 7.2, 1.0 M sodium sulphate
Buffer B: 0.25 mM sodium phosphate, pH 7.2
Flow rate: 0.5 ml/min
Detection: A_{280} . The programmed gradient (FPLC System) is also shown. "Slow" and "fast" α_2 -macroglobulins were identified by native PAGE with PhastSystem.

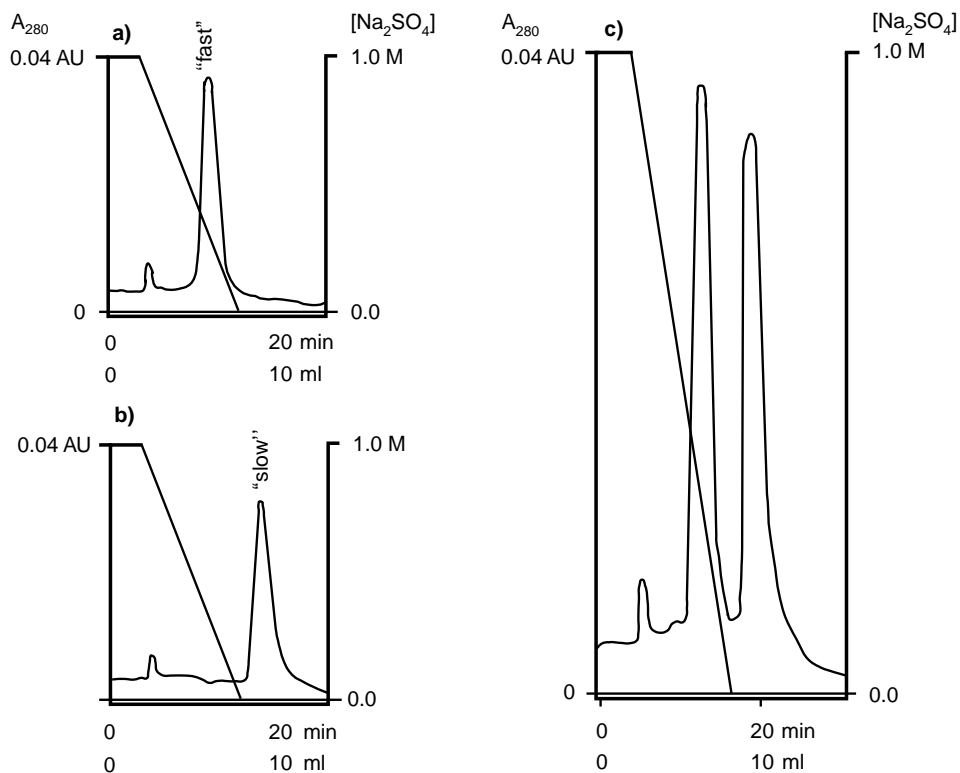

Fig. 39. Separation of conformational isomers of α_2 -macroglobulin using HIC. (Work by Amersham Pharmacia Biotech).

Small scale purification of monoclonal antibodies

Mouse monoclonal antibodies were purified from ascites on a milligram scale. IgG was the main protein in the sample and a single chromatography step with Alkyl Superose HR 5/5 was sufficient to obtain homogeneous IgG (Fig. 38). Purity was checked by SDS-PAGE and silver staining. Both IgG antibodies were well separated from the main contaminants albumin and transferrin. The two antibodies were eluted at clearly different positions (Fig. 38 a, b) in the gradient however, indicating that separation conditions may have to be modified for different antibodies.

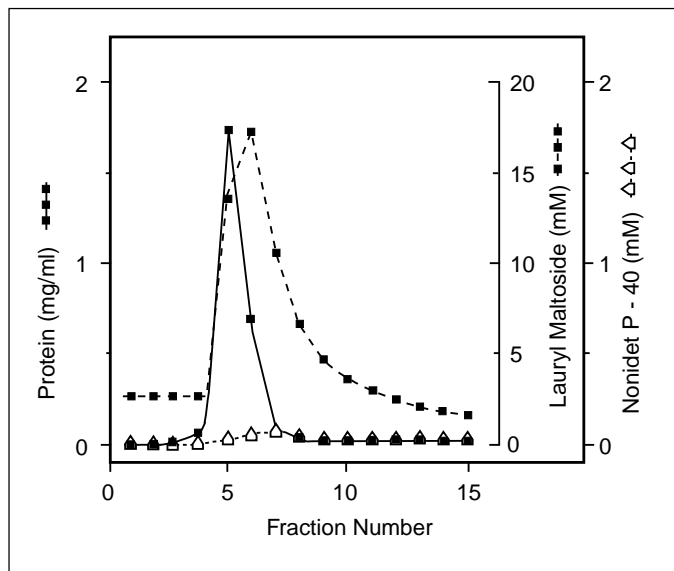

Fig. 40. Exchange of lauryl maltoside for protein-bound Nonidet P-40. (reproduced with permission, from ref. 54).

Analysis of conformational changes with HIC

A conformational change in a protein leads to a change in physico-chemical surface properties, e.g. hydrophobicity, of the molecule. Such changes can be exploited using HIC, offering exciting possibilities both in analytical and preparative applications.

Separation of conformational isomers of α_2 -macroglobulin with HIC

α_2 -macroglobulin, a tetrameric 720K plasma protein, undergoes a major, irreversible conformational change (without peptide bond cleavage) on treatment with methylamine. The two conformational isomers are referred to as ‘slow’ and ‘fast’ α_2 -macroglobulin, respectively, referring to their different mobilities in native PAGE. The two conformational isomers were clearly separated by HIC, using Phenyl Sepharose High Performance (Fig. 39). Ammonium sulphate was avoided, since ammonia mimicks the action of methylamine on the protein.

Other HIC application areas in the research laboratory

HIC using Phenyl Sepharose CL-4B has been used for exchange of protein-bound detergent (54) (Fig. 40). Octyl Sepharose CL-4B has been used for the separation of different forms of dermatan sulphate proteoglycans (55). HIC of nucleic acids, viruses and cells has also been described (17).

Preparative, large scale applications.

When chromatographic techniques are developed to be part of a manufacturing process for a pharmaceutical or a diagnostic for commercial application, they have to comply with special requirements.

As well as meeting demands for productivity and overall economy, the processes also have to fulfil different regulatory requirements regarding final product safety. Regulatory authority requirements are based on the concern that infectious, pyrogenic, immunogenic or tumourigenic agents may be present in the end product.

This section shows some large scale applications that demonstrate how HIC can be integrated into a logical sequence of chromatographic steps intended for a large scale downstream process.

Purification of a monoclonal antibody for clinical studies of passive immunotherapy of HIV-1.

In Sweden, scientists at the National Bacteriological Laboratory (SBL), Department of Virology, in collaboration with Amersham Pharmacia Biotech, have succeeded in developing a purification procedure for large scale production of a monoclonal IgG₁ (anti-gp120) intended for intravenous use for clinical studies on AIDS (56).

The specification for the purification was that the Mab could be used for *in vivo* therapy, which required steps to reduce endotoxins and DNA.

Phenyl Sepharose High Performance was selected for the initial step in a three step procedure that gave a product purity of 99% and an overall yield of 61% (Fig. 41). Phenyl Sepharose High Performance is known to be a good choice for initial purification of monoclonal antibodies. In this case it was compared with an alternative technique consisting of desalting on Sephadex G-25 Super Fine followed by ion exchange chromatography on S Sepharose High Performance. The HIC technique gave superior resolution - no albumin was detected by SDS-PAGE.

The second step on S Sepharose High Performance was included to reduce endotoxins by binding the Mab while allowing the endotoxins to pass unretarded through the column. In fact, it was the final gel filtration step on Superdex™ 200 prep grade that turned out to be the most efficient step for reduction of endotoxins in this case, but the cation step served as a concentration step, meeting the specification for protein concentration in the final product.

The microbiological contamination as well as the DNA and endotoxin levels were all judged to be within the specifications for parenteral use in clinical trials.

All chromatographic runs were performed on BioPilot System. The start material was hybridoma supernatant and the concentration of mouse IgG₁ (anti-gp 120), was 0.61 mg/ml. The method development work was performed on Pharmacia XK columns. Loading capacity for Phenyl Sepharose High Performance was tested by analysing the flow through fractions during sample application by SDS-PAGE and ELISA.

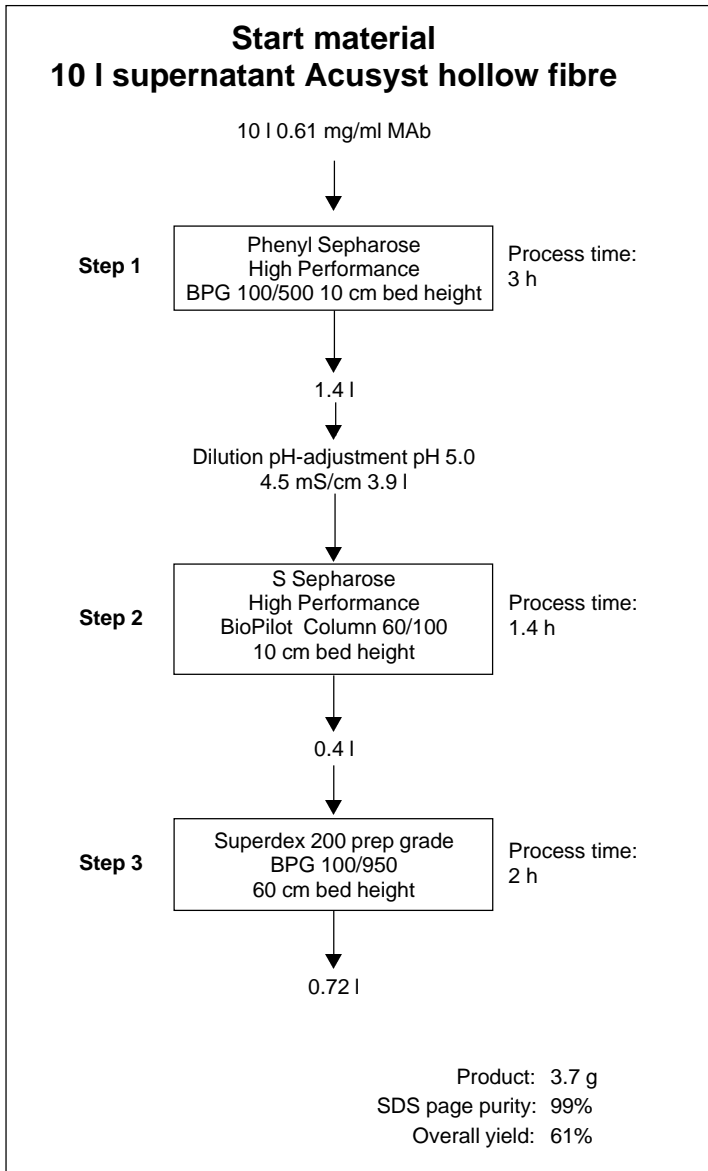

Fig. 41. Purification scheme for a large scale purification of mouse IgG₁ anti-gp120. (Two cycles were run, i.e. a total of 20 l of Mab supernatant).

Dynamic binding capacity was 9.1 mg/ml separation medium at a flow rate of 90 cm/h. As a safety measure only 75% of maximum loading was used. The Mab was eluted with a single step of low salt buffer. The chromatogram and SDS-PAGE showed good resolution and high concentration of the Mab (Fig. 42 a).

For large scale purification, 20 litres of supernatant were divided into 2 lots each containing an equal quantity of Mab. BioProcess Glass Columns were used for the first step on Phenyl Sepharose High Performance and for the final gel filtration step. A BioPilot Column was used for the intermediate step on S Sepharose High Performance. Both resolution and yield (Fig. 42b) were equally good as the small scale run.

Column: XK 16/20
Gel: Phenyl Sepharose High Performance, 10 cm bed height.
Sample: Hybridoma cell culture supernatant; mouse IgG₁ anti-gp120.
Sample volume: 222 ml
Sample load: 6.8 mg Mab/ml gel
Flow rate: 90 cm/h (3 ml/min)
Buffer A: 10 mM potassium phosphate pH 7.0 + 0.5 M ammonium sulphate
Buffer B: 10 mM potassium phosphate pH 7.0
Productivity: 2.32 mg Mab/ml gel · h

Column: BPG 100/500
Gel: Phenyl Sepharose High Performance, 10 cm bed height
Sample: Hybridoma cell culture supernatant; mouse IgG₁ anti-gp120.
Sample volume: 2 x 10 l
Sample load: 7.77 mg Mab/ml gel
Flow rate: 90 cm/h (7.1 l/h)
Buffer A: 10 mM potassium phosphate pH 7.0 + 0.5 M ammonium sulphate
Buffer B: 10 mM potassium phosphate pH 7.0
Productivity: 3.34 mg Mab/ml gel · h

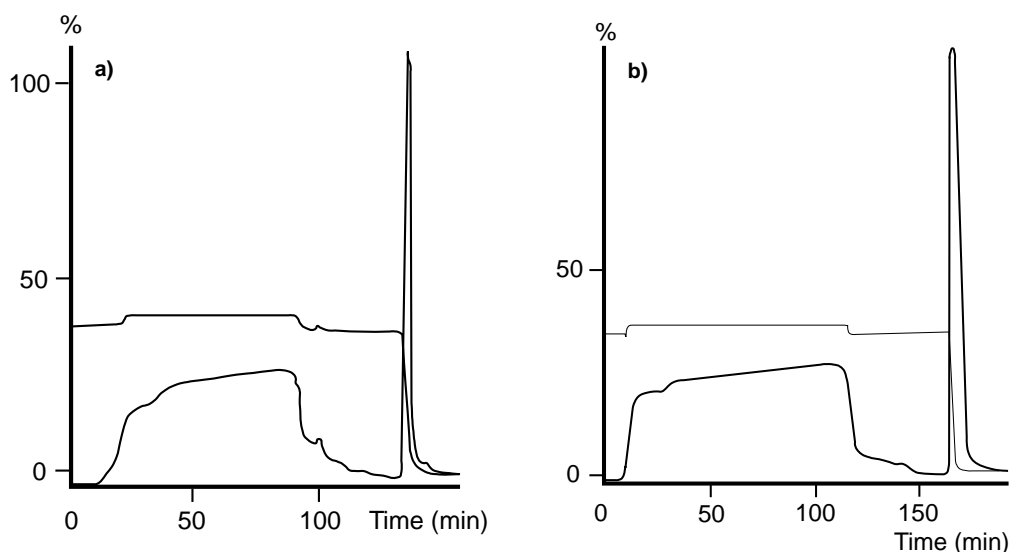

Fig. 42. Laboratory and production scale purification of mouse IgG₁ anti-gp120 on Phenyl Sepharose High Performance (Work from Amersham Pharmacia Biotech, Uppsala, Sweden).

Purification of recombinant human Epidermal Growth Factor (h-EGF) from yeast.

A chromatographic downstream process has been developed for the purification of human Epidermal Growth Factor (h-EGF) expressed as an extracellular product by *Saccharomyces cerevisiae* (57).

Phenyl Sepharose 6 Fast Flow (high sub) was selected for an initial capture step. This was followed by an intermediate anion exchange step on Q Sepharose High Performance and a final polishing gel filtration step on Superdex 75 prep grade.

This three step procedure gave a product purity of 99% as determined by RPC-HPLC, and an overall yield of 73% (Fig. 43).

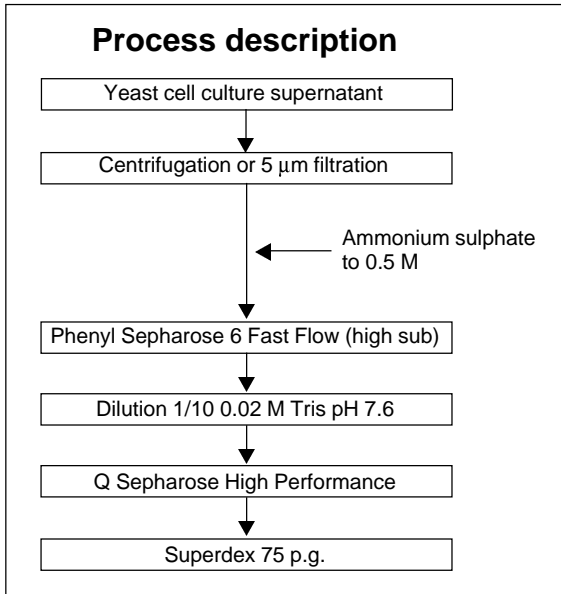

Fig. 43. Purification scheme for large scale purification of h-EGF from yeast cell culture supernatant.

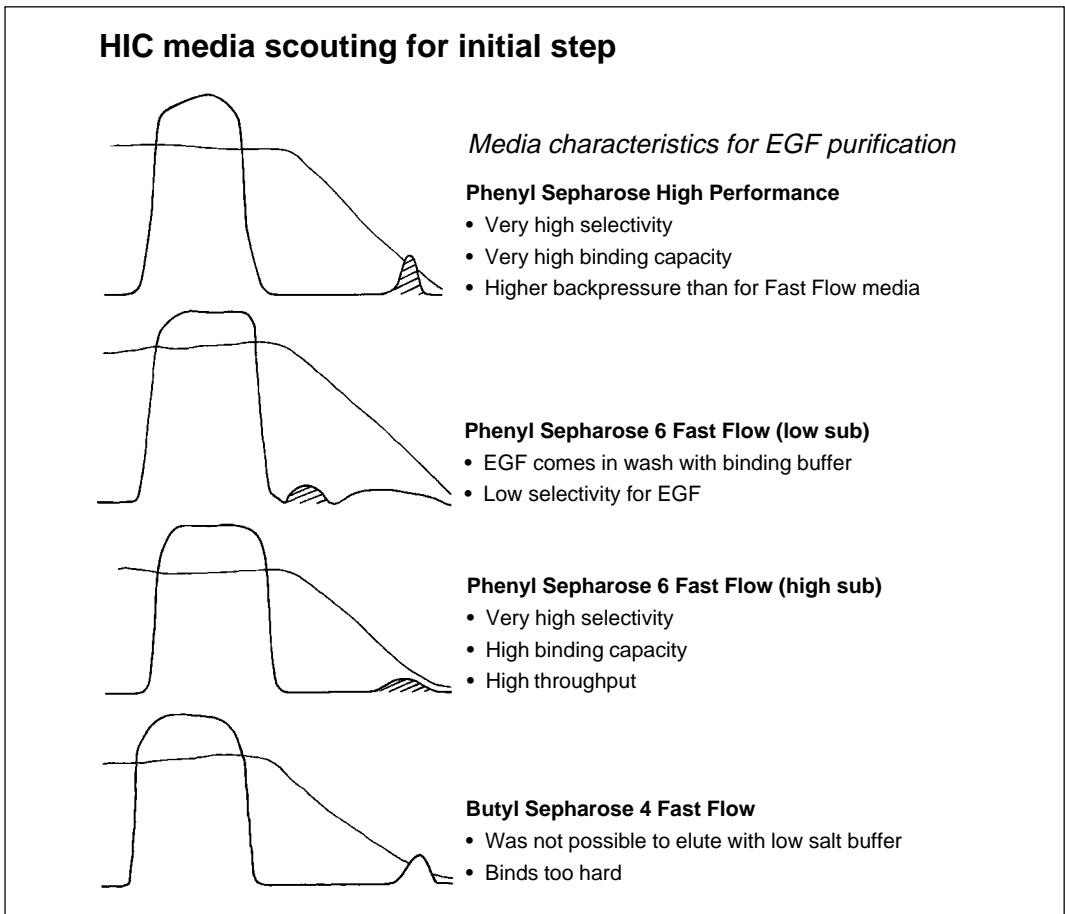

Fig. 44. HIC media screening experiments for the initial capture step. (Work from Amersham Pharmacia Biotech, Uppsala, Sweden).

Initial media screening experiments for the capture step were performed on four different HIC media. Phenyl Sepharose 6 Fast Flow (high sub) was selected due to its high selectivity for EGF, high binding capacity and high throughput (Fig. 44). A cation exchanger (S Sepharose Fast Flow) was also evaluated during this screening phase but was found to have lower selectivity for EGF than Phenyl Sepharose 6 Fast Flow (high sub).

A high resolution anion exchanger, Q Sepharose High Performance, was selected for intermediate purification in order to reach a high degree of purity in the second step (> 96%).

To achieve a high final purity by separating polymers and unwanted buffer salts from the EGF product, gel filtration on Superdex 75 prep grade was selected for final polishing.

The start material was clarified cell culture supernatant supplied by Chiron-Cetus Corp., Emeryville, USA. Concentration of EGF in the start material was 0.018 mg/ml and the overall protein content was 63 mg/ml.

The small scale development work was performed on BioPilot System and XK columns. The product was eluted with a single step procedure which gave adequate purification and high product concentration (Fig. 45).

The large scale purification work was performed on BioProcess System and BioProcess Glass Columns. For the capture step, 80 l of feed material was applied to

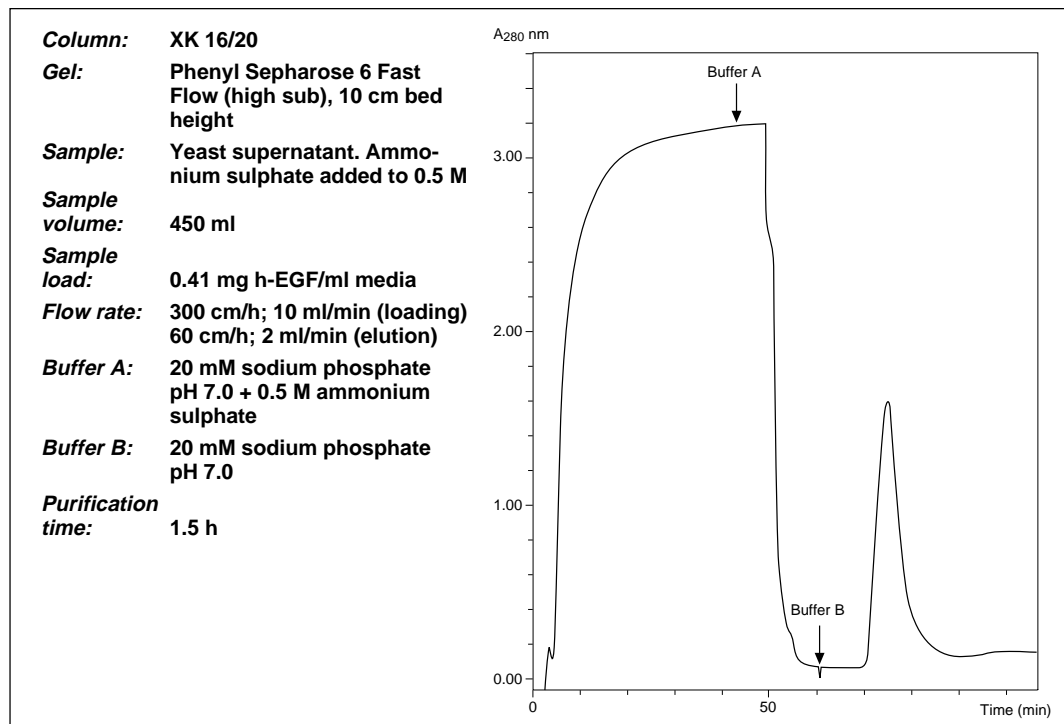

Fig. 45. Laboratory scale purification of h-EGF on Phenyl Sepharose 6 Fast Flow (high sub). (Work from Amersham Pharmacia Biotech, Uppsala, Sweden).

Column: BPG 300/500
Gel: Phenyl Sepharose 6 Fast Flow (high sub), 10 cm bed height
Sample: Yeast supernatant. Ammonium sulphate added to 0.5 M
Sample volume: 80 l
Sample load: 0.36 mg h-EGF/ml media
Flow rate: 300 cm/h; 212 l/h (loading)
 60 cm/h; 42 l/h (elution)
Buffer A: 20 mM sodium phosphate pH 7.0 + 0.5 M ammonium sulphate
Buffer B: 20 mM sodium phosphate pH 7.0
Purification time: 1.5 h

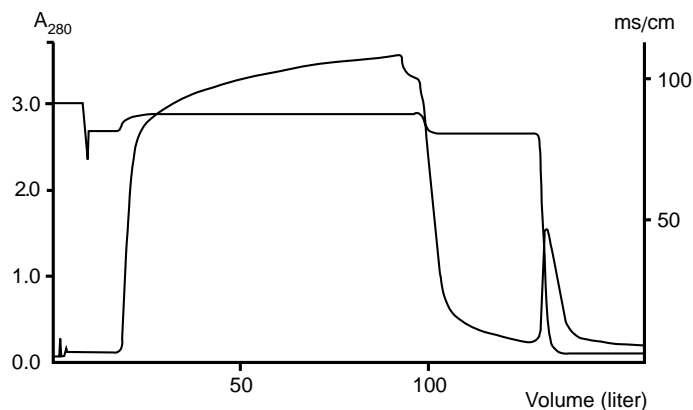

Fig 46. Production scale purification of h-EGF on Phenyl Sepharose 6 Fast Flow (high sub). (Work from Amersham Pharmacia Biotech, Uppsala, Sweden).

a BPG 300/500 column with a bed volume of 7.1 l (Fig. 46). No dilution or recovery losses were seen when scaling up from XK columns on BioPilot System to BPG columns on BioProcess System.

Purification of a monoclonal antibody for *in vitro* diagnostic use.

A single step purification technique for the large scale purification of a monoclonal antibody using HIC has been developed (58).

Purification was performed on Phenyl Sepharose High Performance to a product purity of > 95% and a yield of 78%. If a gel filtration polishing step on Superdex 200 prep grade was added on to the HIC step, a final purity of >99% was achieved (Fig. 47).

The start material, from a hollow fibre bioreactor, was mouse hybridoma cell culture supernatant containing monoclonal IgG₁ anti-IgE. Mab concentration, determined by nephelometry, was 0.63 mg/ml.

Fig. 47.
Purification scheme for the large scale purification of mouse IgG₁, anti-IgE.

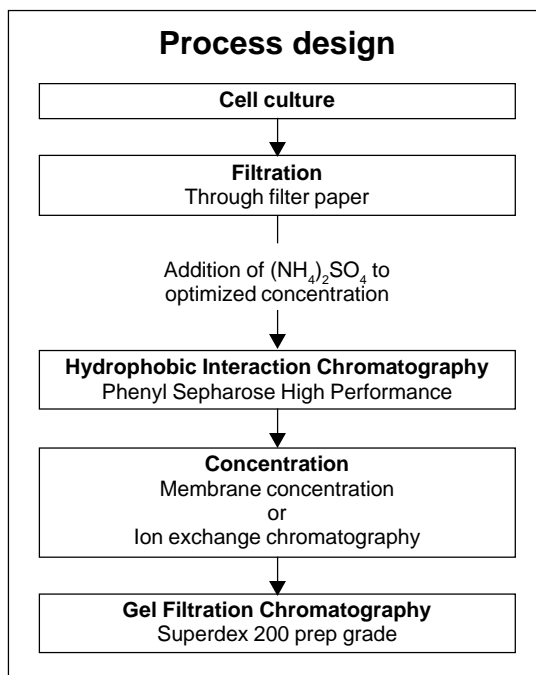

The small scale development work was performed on a HiLoad 16/10 Phenyl Sepharose High Performance column (Fig. 48). The Mab bound very strongly to the gel while most of the fetal calf serum proteins passed through unretarded. Different salt concentrations in the start buffer were tested and 0.5 M ammonium sulphate was selected since this showed the highest binding selectivity for the Mab. At higher salt concentrations, the IgG fraction was slightly contaminated with serum albumin. Dynamic binding capacity was determined to be 4.5 mg Mab/ml gel.

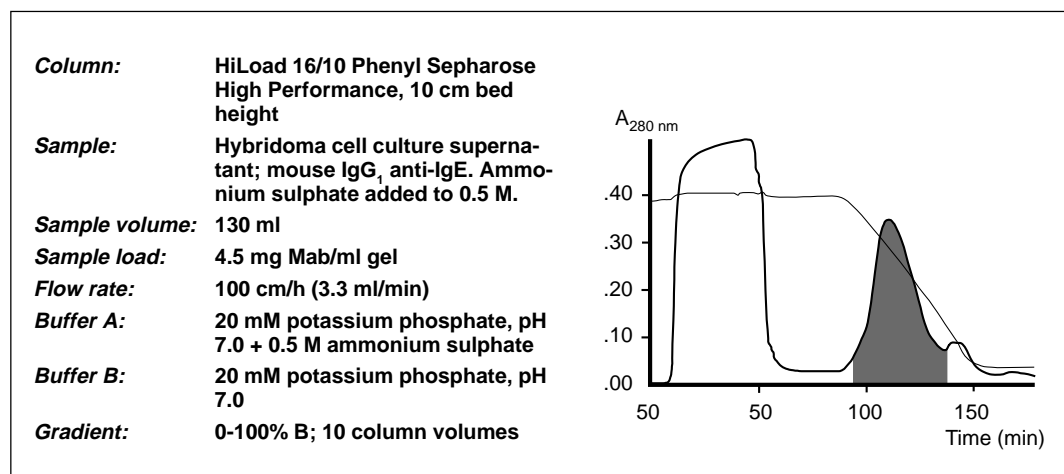

Fig. 48. Laboratory scale purification of mouse IgG₁, anti-IgE, on Phenyl Sepharose High Performance. (Work from Amersham Pharmacia Biotech, Uppsala, Sweden).

Column: BioPilot Column 35/100
Gel: Phenyl Sepharose High Performance, 10 cm bed height
Sample: Hybridoma cell culture supernatant; mouse IgG₁, anti-IgE. Ammonium sulphate added to 0.5 M.
Sample volume: 735 ml
Sample load: 4.5 mg Mab/ml gel
Flow rate: 100 cm/h (16.7 ml/min)
Buffer A: 20 mM potassium phosphate, pH 7.0 + 0.5 M ammonium sulphate
Buffer B: 20 mM potassium phosphate pH 7.0
Gradient: 0–100 % B; 10 column volumes

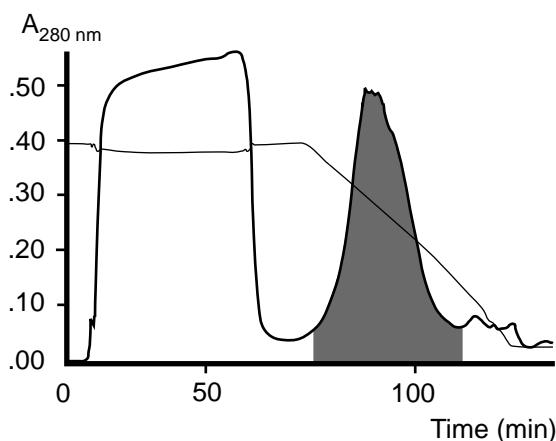

Fig. 49. Production scale purification of mouse IgG₁, anti-IgE, on Phenyl Sepharose High Performance. (Work from Amersham Pharmacia Biotech, Uppsala, Sweden).

The large scale purification was performed on BioPilot System and BioPilot Column Phenyl Sepharose High Performance. The process was first scaled up to a BioPilot Column 35/100 with a total column volume of 100 ml (Fig. 49) and later to a BioPilot Column 60/100 with a total column volume of 300 ml. No difference in performance between the two columns was seen.

An IgG preparation, highly homogeneous by electrophoretic criteria, was obtained in a single chromatographic step. One process cycle yielded over 1 g of IgG from 2.2 litres of culture medium. This corresponds to a capacity of 400 g per year, the productivity of the bioreactor being the limiting step.

Purification of a recombinant *Pseudomonas aeruginosa* exotoxin produced in *E. coli*.

An optimized purification process for a recombinant *Pseudomonas aeruginosa* exotoxin produced in the periplasm of *E. coli* has been developed (59). The scheme resulted in high recovery of a homogeneous exotoxin with reduced levels of DNA, endotoxins, and other contaminants (Table 14).

Table 14.

Step	Medium	Column	Purity %	DNA content (pg)*	Endotoxin content (EU)*
Sample				12 000	
1	DEAE Sepharose Fast Flow	XK 16/20 Bed height 10 cm	325	1 500	2.4 x 10 ⁶
2	Phenyl Sepharose Fast Flow (high sub)	XK 16/20 Bed height 15 cm	365	118	1.2 x 10 ⁶
3	Q Sepharose High Performance	XK 16/20 Bed height 10 cm	>99	8	24
4	Superdex 75 prep grade	XK 16/70 Bed height 60 cm	100	4	5
1	DEAE Sepharose Fast Flow	BPG 100/500 Bed height 10 cm	325	820	2.4 x 10 ⁶
2	Phenyl Sepharose Fast Flow (high sub)	BPG 100/500 Bed height 15 cm	363	118	8.0 x 10 ⁵
3	Q Sepharose High Performance	BPG 100/500 Bed height 10 cm	>99	6	10
4	Superdex 75 prep grade	XK 16/70 Bed height 60 cm	100	N. D.**	6

* = per mg of protein ** = Not Determined

The protein is a well characterized (60–63) cytotoxic agent that acts by irreversibly inhibiting protein synthesis (ADP ribosylation of elongation factor 2). By conjugating the exotoxin to the monoclonal antibody B3, which binds to a carbohydrate epitope present on the surface of many cancer cells (64), an immunotoxin is produced. This type of immunotoxin can then be used as a therapeutic agent for targeted treatment of cancer.

LysPE38, a genetically modified *P. aeruginosa exotoxin*, was purified to support an Investigational New Drug filing with the FDA. The purification strategy involved the extraction of the toxin from the periplasm, followed by clarification and chromatographic purification.

During the method development stages, both anion exchange and HIC were evaluated. By using HIC early in the process, the only sample pretreatment necessary was the addition of a suitable amount of solid ammonium sulphate for binding. Phenyl Sepharose Fast Flow (high sub) was a suitable medium as it demonstrated high selectivity for LysPE38 at a relatively low concentration of ammonium sulphate (0.5 M), an important economic consideration in large scale HIC applications.

Subsequent ion exchange and gel filtration steps were used, but the level of DNA in the purified exotoxin fraction remained high. To remove the DNA from the sample, a DEAE Sepharose Fast Flow anion exchange step was added prior to HIC. The goal was to capture as much DNA as possible at a conductivity high enough to prevent the protein from binding. The DEAE Sepharose Fast Flow was used to remove DNA at a high conductivity so that the subsequent Phenyl Sepharose Fast Flow (high sub) with higher selectivity for LysPE38 could be used as the capture step.

The small scale development work was performed on XK columns. For the HIC step, the salt concentration in start buffer was 0.5 M ammonium sulphate. The column was first eluted with a 5 column volume gradient from 0.5 M ammonium sulphate to 0 M ammonium sulphate (buffer B). Another 5 column volumes of buffer B was used to elute the exotoxin (Fig. 50).

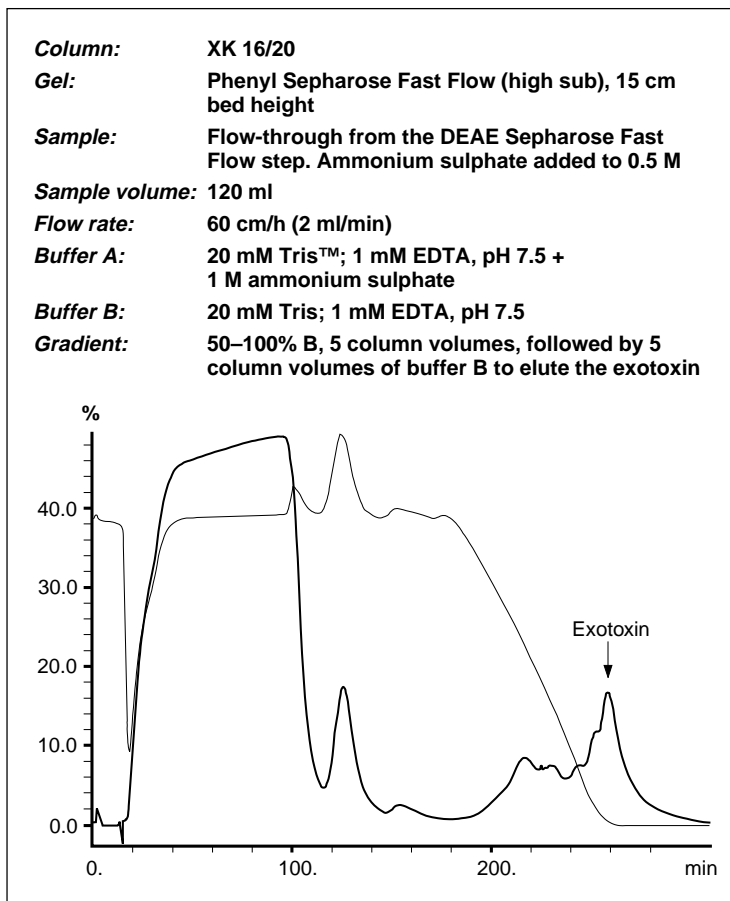
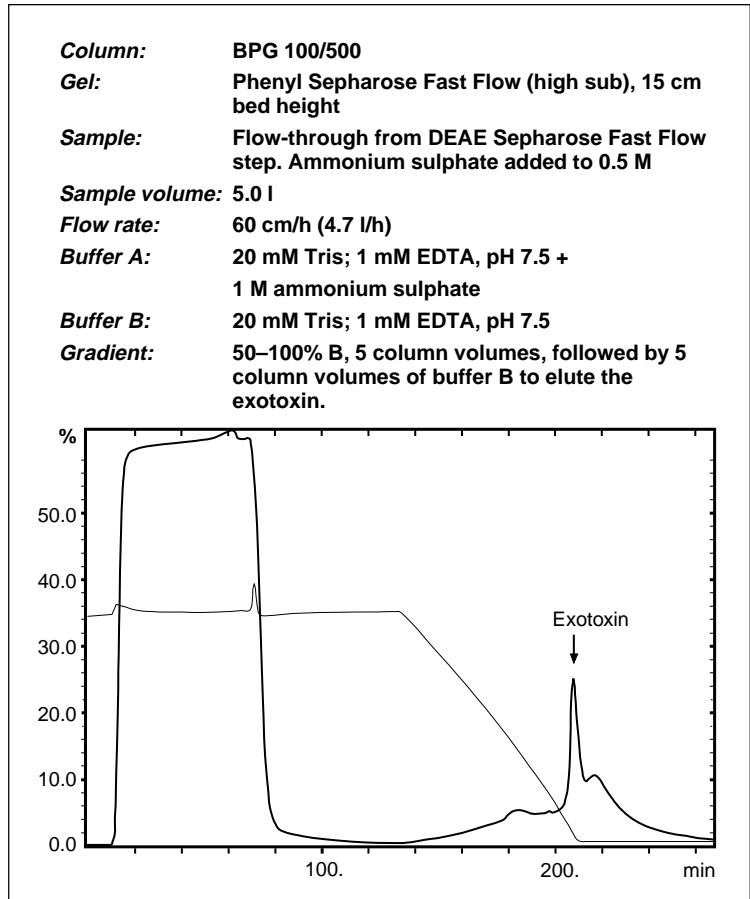

Fig. 50. Laboratory scale purification of a recombinant *Pseudomonas aeruginosa* exotoxin on Phenyl Sepharose Fast Flow (high sub). (Work by National Institute of Health (NIH), Bethesda, U.S.A., in collaboration with Amersham Pharmacia Biotech, Uppsala, Sweden).

The process was scaled up to BioProcess Glass Columns (BPG 100/500), with the exception of the final gel filtration step. The HIC step was run under the same conditions as employed at small scale and no difference in performance was seen (Fig. 51).

A highly homogeneous LysPE38 was obtained with very low content of DNA and endotoxin.

Fig. 51.
Production scale purification of a recombinant *Pseudomonas aeruginosa* exotoxin on Phenyl Sepharose Fast Flow (high sub). (Work by National Institute of Health (NIH), Bethesda, U.S.A., in collaboration with Amersham Pharmacia Biotech, Uppsala, Sweden).



References

1. Adsorption separation by salting out. *Arkiv för Kemi, Mineralogi Geologi* 26B (1948) 1–5, Tiselius, A.
2. Chemical coupling of peptides and proteins to polysaccharides by means of cyanogen halides. *Nature* 214 (1967) 1302–1304, Axén, R., Porath, J., Ernback, S.
3. Preparation of adsorbents for biospecific affinity chromatography. I. Attachment of amino group-containing ligands to insoluble polymers by means of bifunctional oxiranes. *J. Chromatog.* 90 (1974) 87–98, Sundberg, L., Porath, J.
4. Chromatography of lipophilic proteins on adsorbents containing mixed hydrophobic and ionic groups. *Biochem. J.* 126 (1972) 765–767, Yon, R.J.
5. Hydrocarbon-coated Sepharoses. Use in the purification of glycogen phosphorylase. *Biochem. Biophys. Res. Commun.* 49 (1972) 383–390, Er-el, Z., Zaidenzaig, Y., Shaltiel, S.
6. Hydrophobic affinity chromatography of proteins. *Anal. Biochem.* 52 (1973) 430–448, Hofstee, B.H.J.
7. Hydrophobic chromatography: Use for purification of glycogen synthetase. *Proc. Nat. Acad. Sci. USA* 70 (1973) 778–781, Shaltiel, S., Er-el, Z.
8. On the mode of adsorption of proteins to "hydrophobic columns". *Biochem. Biophys. Res. Commun.* 72 (1976) 108–113, Wilchek, M., Miron, T.
9. Hydrophobic chromatography on homologous series of alkyl agaroses. A comparison of charged and electrically neutral column materials. *J. Chromatog.* 215 (1981) 211–228, Halperin, G., Breitenbach, M., Tauber-Finkelstein, M., Shaltiel, S.
10. Salting-out in amphiphilic gels as a new approach to hydrophobic adsorption. *Nature* 245 (1973) 465–466, Porath, J., Sundberg, L., Fornstedt, N., Olson, I.
11. Hydrophobic interaction chromatography. The synthesis and the use of some alkyl and aryl derivatives of agarose. *J. Chromatog.* 101 (1974) 281–288, Hjertén, S., Rosengren, J., Pählman, S.
12. Hydrophobic interaction chromatography on Phenyl- and Octyl-Sepharose CL-4B. in: *Chromatography of synthetic and biological macromolecules*. Roger, E. Ed., Ellis Horwood Ltd., Chichester, England, 1978. Janson, J.-C., Låås, T.
13. Hydrophobic interaction chromatography of serum proteins on Phenyl-Sepharose CL-4B. *J. Chromatog.* 242 (1982) 385–388, Hrkál, Z., Rejnkova, J.
14. Proteins of the kidney microvillar membrane. The amphipathic form of dipeptidyl peptidase IV. *Biochem. J.* 179 (1979) 379–395, McNair, R.D., Kenny, A.J.

15. Nuclear proteins. VI. Fractionation of chromosomal non-histone proteins using hydrophobic chromatography. *Biochim. Biophys. Acta* 563 (1979) 253–260, Comings, D.E., Miguel, A.G., Lesser, H.H.
16. Hydrophobic interaction chromatography as a tool in insulin receptor study. *Proc. 2nd. Intl. Insulin Symp. (1980)* 243–250, Kuehn, L., Meyer, H., Reinauer, H.
17. Hydrophobic interaction chromatography of proteins, nucleic acids, viruses and cells on non-charged amphiphilic gels, in: *Methods of Biochemical Analysis (D. Glick, ed.)*, John Wiley & Sons, Inc., 1981, pp. 89–108. Hjertén, S.
18. Hydrophobic adsorbants for the isolation and purification of biosynthetic human growth hormone from crude fermentation mixtures. *J. Chromatog.* 361 (1986) 209–216, Lefort, S., Ferrara, P.
19. Purification of recombinant hepatitis B surface antigen produced by transformed Chinese hamster ovary (CHO) cell line grown in culture. *Bioseparation* 1 (1991) 397–408, Belew, M., Yafang, M., Bin, L., Berglöf, J., Janson, J-C.
20. Utilization of hydrophobic interaction for the formation of an enzyme reactor bed. *Biotechnology & Bioengineering* 17 (1975) 613–616, Caldwell, K.D., Axén, R., Porath, J.
21. Immobilization of phospholipid vesicles on alkyl derivatives of agarose gel beads. *Biochim. Biophys. Acta* 924 (1987) 185–192, Sandberg, M., Lundahl, P., Greijer, E., Belew, M.
22. The hydrophobic effect: formation of micelles and biological membranes. Tanfor, C., John Wiley & sons, New York, 1973.
23. Proteins, structure and molecular properties. Creighton, T.E., W.E. Freeman, New York, 1984.
24. Salt-promoted adsorption: recent developments. *J. Chromatog.* 376 (1986) 331–341, Porath, J.
25. Fractionation of proteins by hydrophobic interaction chromatography, with reference to serum proteins. *Proceedings Intl. Workshop on Technology for Protein Separation & Improvement of Blood Plasma Fractionation*. Reston, Virginia, 1977, 410–421, Hjertén, S.
26. Fractionation of proteins by fractional interfacial salting out on unsubstituted agarose gels. *Biochem. Biophys. Res. Comm.* 70 (1976) 1009–1013, von der Haar, F.
27. Salt effects on hydrophobic interactions in precipitation and chromatography of proteins: an interpretation of the lyotropic series. *Arch. Biochem. Biophys.* 183 (1977) 200–215, Melander, W., Horvath, C.
28. Solubility chromatography of serum proteins. II. Partial purification of the second component of guinea pig complement by solubility chromatography in concentrated ammonium sulphate solutions. *J. Chromatog.* 40 (1969) 53–61, Hoffmann, L.G., McGivern, P.W.
29. Role of physical forces in hydrophobic interaction chromatography. *Separation & Purification Methods* 9 (1980) 267–370, Srinivasan, R., Ruckenstein, E.
30. Non-ionic adsorption chromatography of proteins. *J. Chromatog.* 159 (1978) 57–69, Hofstee, B.H.J, Otilio, N.F.
31. General aspects of hydrophobic chromatography. Adsorption and elution characteristics of some skeletal muscle enzymes. *Biochemistry* 14 (1975) 754–760, Jennissen, H.P., Heilmeyer, I.M.G.
32. Hydrophobic interaction chromatography on non-charged Sepharose derivatives. Binding of a model protein, related to ionic strength, hydrophobicity of the substituent, and degree of substitution (determined by NMR). *Biochim. Biophys. Acta* 412 (1975) 51–61, Rosengren, J., Pahlman, S., Glad, M., Hjertén, S.
33. Agar derivatives for chromatography, electrophoresis & gel-bound enzymes. IV. Benzylated dibromopropanol cross-linked Sepharose as an amphiphilic gel for hydrophobic salting out chromatography of enzymes with special emphasis on denaturing risks. *J. Chromatog.* 111 (1975) 373–387, Låås, T.

34. Multivalent interaction chromatography as exemplified by the adsorption and desorption of skeletal muscle enzymes on hydrophobic alkyl-ligands. *J. Chromatog.* 159 (1978) 71–83, Jennissen, H.P.
35. Synthesis of new hydrophobic adsorbents based on homologous series of uncharged alkyl sulphide agarose derivatives. *J. Chromatog.* 321 (1985) 305–317, Maisano, F., Belew, M., Porath, J.
36. Hydrophobic interaction chromatography on uncharged Sepharose derivatives. Effects of neutral salts on the adsorption of proteins. *J. Chromatog.* 131 (1977) 99–108, Pählman, S., Rosengren, J., Hjertén, S.
37. Displacement of water and its control of biochemical reactions. Levin, S., *Academic Press, New York, 1974.*
38. Hydrophobic interaction chromatography of proteins on neutral adsorbents, in: *Methods of protein separation*, vol. 2. Catsimpoilas, N., Ed., *Plenum Publishing Corporation, New York, 1976.* Hjertén, S.
39. Temperature-dependent van der Waals forces. *Biophys. J.* 10 (1970) 664–674, Parsegian, V.A., Ninham, B.W.
40. Separation of lipoamide dehydrogenase isoenzymes by affinity chromatography. *Biochim. Biophys. Acta* 384 (1975) 69–80, Visser, J., Strating, M.
41. Some general aspects of hydrophobic interaction chromatography. *J. Chromatog.* 87 (1973) 325–331, Hjertén, S.
42. Gradient and isocratic High Performance Hydrophobic Interaction Chromatography of proteins on agarose columns. *J. Chromatog.* 359 (1986) 99–109, Hjertén, S., Yao, K., Eriksson, K.-O., Johansson, B.
43. Determination of the leakage from Phenyl Sepharose CL-4B, Phenyl Sepharose Fast Flow and Phenyl Superose in bulk and column experiments. *J. Chromatog.* 403 (1987) 85–98, Johansson, B.-L., Hellberg, U., Wennberg, O.
44. Comparison of molecular structures of proteins: Helix content; distribution of apolar residues. *Arch. Biochem. Biophys.* 138 (1970) 704–706, Klotz, I.M.
45. The interpretation of protein structures: estimation of static accessibility. *J. Mol. Biol.* 55 (1971) 397–400, Lee, B., Richards, F.M.
46. Characterization of hydrophobic interaction and Hydrophobic Interaction Chromatography media by multivariate analysis. *J. Chromatog.* 599 (1992) 131–136, Kärsnäs, P., Lindblom, T.
47. Differences in retention behavior between small and large molecules in Ion Exchange Chromatography and Reversed Phase Chromatography. *Anal. Biochem.* 142 (1984) 134–139, Ekström, B., Jacobson, G.
48. Electron-donor-acceptor chromatography (EDAC) for biomolecules in aqueous solutions, in: *Protein recognition of immobilized ligands*, *Alan R. Liss, Inc., (1989) pp. 101–122*, Porath, J.
49. Identification, purification and partial sequence analysis of Autotaxin, a novel motility-stimulating protein. *J. Biol. Chem.* 267 (1992) 2524–2529, Stracke, M.L., Krutzsch, H.C., Unsworth, E.J., Årestad, A., Cioce, V., Schiffmann, E., Liotta, L.A.
50. Expression, Purification and Crystallization of the HIV-1 Reverse Transcriptase (RT). *AIDS Res. Hum. Retrovir.* 6 (1990) 1297–1303, Unge, T., Ahola, H., Bhikhabhai, R., Bäckbro, K., Lövgren, S., Fenyö, E.M., Honigman, A., Panet, A., Gronowitz, G.S., Strandberg, B.
51. Factors involved in specific transcription by mammalian RNA polymerase II. Identification and characterization of Factor II H. *J. Biol. Chem.* 267 (1992) 2786–2793, Flores, O., Lu, H., Reinberg, D.

52. A multidimensional HPLC strategy for the purification of proteins and peptides for micro-sequence analysis: - The role of micropreparative ion exchange columns. Poster presented at the *10th International Symposium of Proteins, Peptides and Polynucleotides, Wiesbaden, Germany, October 1990*, Nice, E., Fabri, L., Burgess, A., Simpson, R., Hellman, V., Andersson, K.
53. Isolation of Human Pituitary Prolactin. *Biochim. Biophys. Acta* **588** (1979) 368–379, Roos, P., Nyberg, F., Wide, L.
54. Phenyl-Sepharose-mediated Detergent-Exchange Chromatography: Its application to exchange of detergents bound to membrane proteins. *Biochemistry* **23** (1984) 6121–6126, Robinson, N.C., Wiginton, D., Talbert, L.
55. Characterization of the dermatan sulphate proteoglycans, DS-PGI and DS-PGII, from bovine articular cartilage and skin isolated by Octyl Sepharose chromatography. *J. Biol. Chem.* **264** (1989) 2876–2884, Choi, H.U., Johnson, T.L., Pal, S., Tang, L.-H., Rosenberg L., Neame, P.J.
56. Production and purification of murine monoclonal antibodies directed against HIV-1, for use in passive immunotherapy of HIV-1. Poster presented at *Biotech 92; International Symposium; New Generation of Monoclonal Antibodies in Diagnosis and Therapy, Genoa, Italy, April 1992*, Gilljam, G., Hinkula, J., Daniels, A.I., Wahren, B.
57. Development and a scale up study of a chromatographic downstream process for the purification of recombinant EGF. Poster presented at *Ninth International Biotechnology Symposium, Crystal City, Virginia, USA, August 1992*, Daniels, A.I., Pettersson, N.T.
58. Characterization of Phenyl Sepharose High Performance – a new 34 µm medium for Hydrophobic Interaction Chromatography. Poster presented at *32nd International Union of Pure and Applied Chemistry (IUPAC) Congress, Stockholm, Sweden, August 1989*, Daniels, A.I., Weitman, A., Westin, G., Söderström, L.
59. Production of clinical grade recombinant Exotoxin A from *E. Coli*. Presented at *Recovery of Biological Products VI, An Engineering Foundation Conference, Interlaken, Switzerland, September 1992*, Tsai, A.M., Kaufman, J.B., Shiloach, J., Gallo, M., Fass, S.
60. Recombinant toxins for cancer treatment. *Science* **254** (1991) 1173–1177, Pastan, I., FitzGerald, D.
61. Structure of exotoxin A of *Pseudomonas aeruginosa* at 3.0-Ångström resolution. *Proc. Natl. Acad. Sci. USA* **83** (1986) 1320–1324, Allured, V.S., Collier, R.J., Carroll, S.F., McKay, D.B.
62. Functional domains of *Pseudomonas* exotoxin identified by deletion analysis of the gene expressed in *E. Coli*. *Cell* **48** (1987) 129–136, Hwang, J., FitzGerald, D.J., Adhya, S., Pastan, I.
63. Functional analysis of domains II, Ib, and III of *Pseudomonas* exotoxin. *J. Biol. Chem.* **264** (1989) 14256–14261, Siegall, C.B., Chaudhary, V.K., FitzGerald, D.J., Pastan, I.
64. Anti-tumor activities of immunotoxins made of monoclonal antibody B3 and various forms of *Pseudomonas* exotoxin. *Proc. Natl. Acad. Sci. USA* **88** (1991) 3358–3362, Pai, L.H., Batra, J.K., FitzGerald, D.J., Willingham, M.C., Pastan, I.
65. Solvent modulation in Hydrophobic Interaction Chromatography. *Biotechnol. Appl. Biochem.* **13** (1991) 151–172, Arakawa T., Narhi, L.O.
66. Hydrophobic Interaction Chromatography in alkaline pH. *Anal. Biochem.* **182** (1989) 266–270, Narhi, L.O., Kita, Y., Arakawa, T.

Ordering information

Product/Bulk media	Pack size	Code No.
Phenyl Sepharose 6 Fast Flow (low sub)	200 ml	17-0965-05
	1 l	17-0965-03
	5 l	17-0965-04
Phenyl Sepharose 6 Fast Flow (high sub)	200 ml	17-0973-05
	1 l	17-0973-03
	5 l	17-0973-04
Butyl Sepharose 4 Fast Flow	200 ml	17-0980-01
	500 ml	17-0980-02
	5 l	17-0980-04
Octyl Sepharose 4 Fast Flow	25 ml	17-0946-10
	200 ml	17-0946-02
	500 ml	17-0946-05
	1 l	17-0946-03
	5 l	17-0946-04
Phenyl Sepharose High Performance	75 ml	17-1082-01
	1 l	17-1082-03
	5 l	17-1082-04
Phenyl Sepharose CL-4B	50 ml	17-0810-02
	200 ml	17-0810-01
	10 l	17-0810-05
Octyl Sepharose CL-4B	50 ml	17-0790-02
	200 ml	17-0790-01
	10 l	17-0790-05
SOURCE™ 15ETH	50 ml	17-0146-01
	200 ml	17-0146-02
	1 l	17-0146-04
SOURCE 15ISO	50 ml	17-0148-01
	200 ml	17-0148-02
	1 l	17-0148-04
SOURCEPHE	50 ml	17-0147-01
	200 ml	17-0147-02
	1 l	17-0147-04
	5 l	17-0147-05
Product/Prepacked columns		
	Bed volume	Code No.
HiTrap™ HIC test kit	5 x 1 ml	17-1349-01
HiLoad™ 16/10 Phenyl Sepharose HP	20 ml	17-1085-01
HiLoad 26/10 Phenyl Sepharose HP	53 ml	17-1086-01
Alkyl Superose HR 5/5	1 ml	17-0586-01
Alkyl Superose HR 10/10	8 ml	17-0587-01
Phenyl Superose HR 5/5	1 ml	17-0519-01
Phenyl Superose HR 10/10	8 ml	17-0530-01
Phenyl Superose PC 1.6/5	0.1 ml	17-0772-01
RESOURCE™ 15ETH	1 ml	17-1184-01
RESOURCE 15ISO	1 ml	17-1185-01
RESOURCE 15PHE	1 ml	17-1186-01
RESOURCE HIC Test kit		17-1187-01
RESOURCE 15PHE PE 4.6/100		17-1171-01



amersham pharmacia biotech

ISBN 91-970490-4-2