

Ion Exchange Chromatography

Principles and Methods

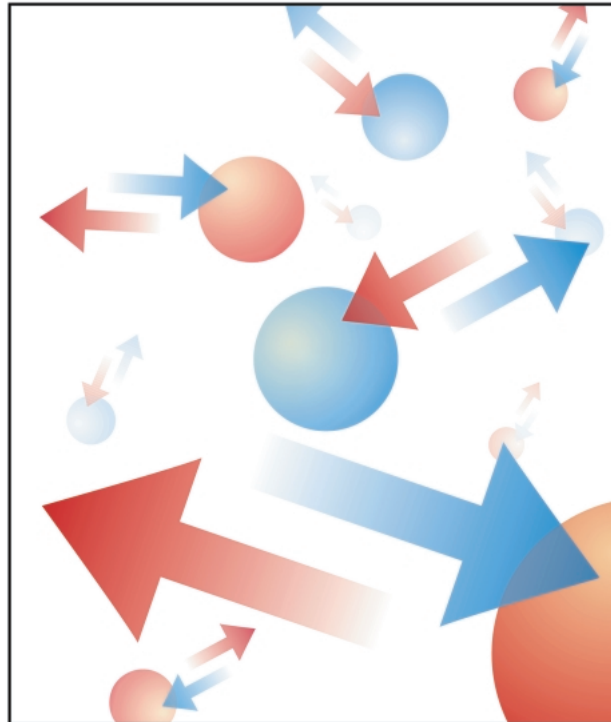

18-1114-21

Edition AA



amersham pharmacia biotech

Ion Exchange Chromatography

Principles and Methods

ISBN 91 970490-3-4

Contents

1. Introduction	9
2. Ion exchange chromatography	10
The theory of ion exchange	10
The matrix.....	11
Charged groups	13
Resolution in ion exchange chromatography	13
<i>Capacity factor</i>	15
<i>Efficiency</i>	16
<i>Selectivity</i>	17
Capacity	18
3. Product Guide	20
MonoBeads	20
MiniBeads	20
SOURCE	20
Sephacel High Performance ion exchangers	21
Sephacel Fast Flow ion exchangers	21
Sephacel Big Beads ion exchangers.....	21
STREAMLINE ion exchangers	21
DEAE Sepharose CL-6B and CM Sepharose CL-6B	22
DEAE Sephacel.....	22
Sephadex ion exchangers	22
Bulk quantities.....	22
Equipment.....	22
4. MonoBeads and MiniBeads	23
MonoBeads.....	23
Properties	24
<i>Chemical stability</i>	24
<i>Physical stability</i>	25
<i>Flow rate</i>	27
<i>Capacity</i>	27
<i>Recovery</i>	28
<i>Reproducibility</i>	29
Availability	30
MiniBeads	30
Properties	31
<i>Chemical stability</i>	31
<i>Physical stability</i>	32
<i>Reproducibility</i>	33
Availability	33

5. SOURCE	34
Properties	37
<i>Chemical stability</i>	37
<i>Flow rate</i>	38
<i>Capacity</i>	40
<i>Recovery</i>	40
<i>Reproducibility</i>	41
Availability	41
6. Sepharose based ion exchangers	42
Chemical stability	42
Physical stability	43
Sepharose High Performance ion exchangers.....	43
Properties	44
<i>Physical stability</i>	44
<i>Capacity</i>	44
<i>Flow rate</i>	46
Availability	46
Sepharose Fast Flow ion exchangers	46
Properties	47
<i>Physical stability</i>	47
<i>Capacity</i>	47
<i>Flow rate</i>	49
Availability	50
Sepharose Big Beads ion exchangers.....	50
Properties	51
<i>Physical properties</i>	51
<i>Capacity</i>	51
<i>Flow rate</i>	51
Availability	51
STREAMLINE SP and STREAMLINE DEAE	52
Properties	53
<i>Physical stability</i>	53
<i>Capacity</i>	53
Availability	54
DEAE Sepharose CL-6B and CM Sepharose CL-6B.....	54
Properties	54
<i>Physical stability</i>	54
<i>Capacity</i>	55
<i>Flow rate</i>	56
Availability	57
7. DEAE Sephacel	58
Properties	58
<i>Chemical stability</i>	58
<i>Physical stability</i>	59

	<i>Capacity</i>	59
	<i>Flow rate</i>	60
	Availability	60
8. Sephadex ion exchangers		61
	Properties	61
	<i>Chemical stability</i>	61
	Physical stability	62
	<i>Swelling</i>	62
	<i>Ionic strength dependence</i>	62
	<i>pH dependence</i>	62
	<i>Capacity</i>	62
	Availability	64
9. Experimental design		65
	Choice of ion exchanger	65
	Specific requirements of the application	65
	<i>Column separation, batch separation or</i> <i>expanded bed adsorption</i>	65
	<i>The scale of the separation</i>	65
	<i>The required resolution</i>	65
	<i>The required throughput</i>	66
	<i>Scaleability</i>	66
	<i>Reproducibility</i>	67
	<i>Economy</i>	67
	The molecular size of the sample components	67
	Choice of exchanger group	68
	Determination of starting conditions	69
	<i>The isoelectric point</i>	69
	<i>Test-tube method for selecting starting pH</i>	69
	<i>Electrophoretic titration curves (ETC)</i>	70
	<i>Chromatographic titration curves (retention maps)</i>	74
	Choice between strong and weak ion exchangers	76
	Choice of buffer	76
	<i>Choice of buffer pH and ionic strength</i>	76
	<i>Choice of buffer substance</i>	77
	<i>Test-tube method for selecting starting ionic strengths</i>	79
10. Experimental Technique		80
	Column chromatography	80
	Choice of column.....	80
	<i>Column design</i>	80
	<i>Column dimensions</i>	81
	Quantity of ion exchanger	81
	Preparation of the ion exchanger	81
	<i>Pre-swollen ion exchangers</i>	81

<i>Pre-packed ion exchange media</i>	81
<i>Sephadex ion exchangers</i>	82
<i>Alternative counter-ions</i>	82
<i>Decantation of fines</i>	82
Packing the column.....	82
<i>Column Packing Video Film</i>	82
<i>Checking the packing</i>	83
<i>Equilibrating the bed</i>	84
Sample preparation.....	85
<i>Sample concentration</i>	85
<i>Sample composition</i>	85
<i>Sample volume</i>	85
<i>Sample viscosity</i>	85
<i>Sample preparation</i>	86
Sample application	87
<i>Sample application with an adaptor</i>	87
<i>Other methods of sample application</i>	89
<i>Sample application onto a drained bed</i>	89
<i>Sample application under the eluent</i>	89
Elution	90
<i>Change of pH</i>	90
<i>Change of ionic strength</i>	91
<i>Gradient direction</i>	91
<i>Choice of gradient type</i>	91
<i>Resolution using a continuous gradient</i>	93
<i>Choice of gradient shape</i>	94
<i>Sample displacement</i>	95
Gradient generation.....	96
<i>Gradient formation with two pumps or a single pump</i>	96
<i>in combination with a switch valve</i>	
<i>Gradient Mixer</i>	96
Batch separation	97
Expanded bed adsorption	98
Expanded bed technology	99
Basic principle of operation.....	99
STREAMLINE adsorbents	100
STREAMLINE columns	100
Auxiliary equipment	100
Regeneration	101
Cleaning, sanitization and sterilization procedures	101
Cleaning	101
Sanitization	101
Sterilization	101
Protocols for cleaning-in-place (CIP),.....	102
sanitization and sterilization	

<i>SOURCE and Sepharose Based ion exchangers</i>	102
<i>MonoBeads and MiniBeads columns</i>	102
<i>DEAE Sephacel and Sephadex based ion exchangers</i>	103
Storage of gels and columns	103
<i>Prevention of microbial growth</i>	103
<i>Storage of unused media</i>	104
<i>Storage of used media</i>	104
<i>Storage of packed columns</i>	104
Determination of the available and dynamic capacities.....	104
<i>Calculation</i>	106
11. Process considerations	107
Defining the purpose	108
The strategic focus	109
Capture	109
Intermediate purification	111
Polishing.....	111
Selection of chromatography media	112
<i>Base matrix properties and derivitization chemistry</i>	113
<i>Bead size</i>	113
<i>Documentation and technical support</i>	113
<i>Regulatory support</i>	113
<i>Vendor certification</i>	114
<i>Delivery capacity</i>	114
Method design and optimization	114
Binding conditions	114
Elution	115
Sample load	116
Flow rate	117
Selecting a column	118
Aspects of column design	119
<i>Flow distribution system</i>	119
<i>Material resistance and durability</i>	119
<i>Sanitary design</i>	119
<i>Pressure vessel safety</i>	120
<i>Regulatory support</i>	120
<i>Ergonomics</i>	120
Packing large scale columns.....	120
Column configuration	120
Packing the column.....	121
Scale-up	121

12. Applications	124
The design of a biochemical separation	124
Application examples	127
<i>Enzymes</i>	127
<i>Isoenzymes</i>	128
<i>Immunoglobulins</i>	129
<i>Nucleic acid separation</i>	129
<i>Polypeptides and polynucleotides</i>	130
<i>Antisense phosphorothioate oligonucleotides</i>	132
Areas of application.....	133
Purification of a recombinant <i>Pseudomonas</i>	136
<i>aeruginosa</i> exotoxin A, PE553D	
<i>Strategy</i>	141
13. Fault-finding chart	143
14. Ordering information	151
15. References	155



BioProcess Media are designed, manufactured and supported for industrial bioprocessing.

This symbol is your guarantee of:

- Assured long term supply of large batches, on time and with the right quality.
- Full technical and regulatory support to assist in process validation.
- Scalable performance from bench top to production hall.
- Compatible large scale columns and equipment.
- Well documented cleaning and sanitization methods.
- Media shown to perform well in real downstream applications – from Capture to Polishing, from synthetic oligonucleotides to recombinant proteins.
- High and reliable productivity in the production hall.

Media that fulfill the above described criteria are labelled with the BioProcess Media symbol in Chapter 3.

1. Introduction

Adsorption chromatography depends upon interactions of different types between solute molecules and ligands immobilized on a chromatography matrix. The first type of interaction to be successfully employed for the separation of macromolecules was that between charged solute molecules and oppositely charged moieties covalently linked to a chromatography matrix. The technique of ion exchange chromatography is based on this interaction.

Ion exchange is probably the most frequently used chromatographic technique for the separation and purification of proteins, polypeptides, nucleic acids, polynucleotides, and other charged biomolecules (1). The reasons for the success of ion exchange are its widespread applicability, its high resolving power, its high capacity, and the simplicity and controllability of the method.

This handbook is designed as an introduction to the principles of ion exchange chromatography and as a practical guide to the use of the media available from Pharmacia Biotech. The handbook is illustrated with examples of different types of biological molecules which have been separated using ion exchange chromatography and different ways the technique can be used. For information on specific separations, the reader is recommended to consult the original literature.

2. Ion exchange chromatography

The theory of ion exchange

Separation in ion exchange chromatography depends upon the reversible adsorption of charged solute molecules to immobilized ion exchange groups of opposite charge. Most ion exchange experiments are performed in five main stages. These steps are illustrated schematically below.

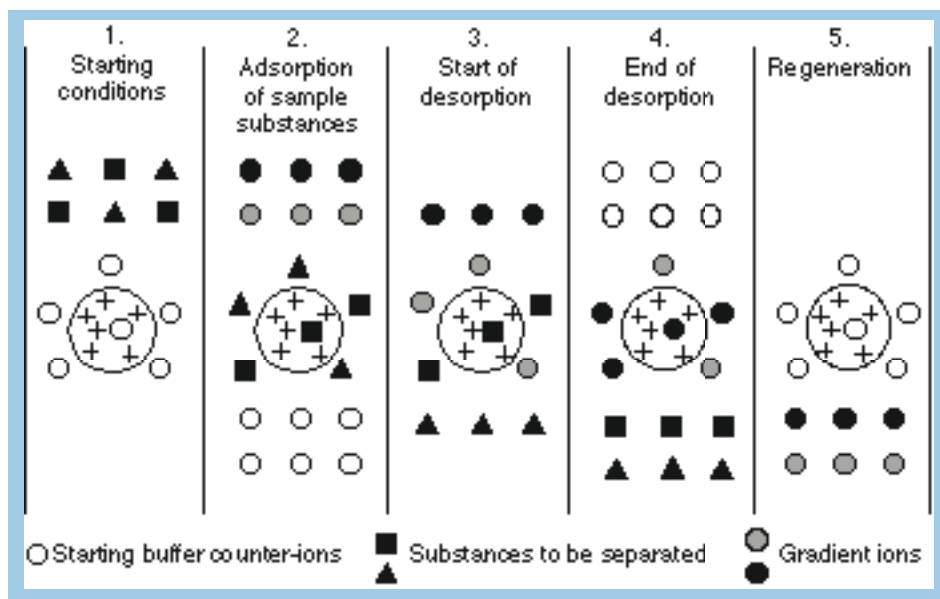

Fig. 1. The principle of ion exchange chromatography (salt gradient elution).

The first stage is equilibration in which the ion exchanger is brought to a starting state, in terms of pH and ionic strength, which allows the binding of the desired solute molecules. The exchanger groups are associated at this time with exchangeable counter-ions (usually simple anions or cations, such as chloride or sodium).

The second stage is sample application and adsorption, in which solute molecules carrying the appropriate charge displace counter-ions and bind reversibly to the gel. Unbound substances can be washed out from the exchanger bed using starting buffer.

In the third stage, substances are removed from the column by changing to elution conditions unfavourable for ionic bonding of the solute molecules. This normally involves increasing the ionic strength of the eluting buffer or changing its pH. In Figure 1 desorption is achieved by the introduction of an increasing salt concentration gradient and solute molecules are released from the column in the order of their strengths of binding, the most weakly bound substances being eluted first.

The fourth and fifth stages are the removal from the column of substances not eluted under the previous experimental conditions and re-equilibration at the starting conditions for the next purification.

Separation is obtained since different substances have different degrees of interaction with the ion exchanger due to differences in their charges, charge densities and distribution of charge on their surfaces. These interactions can be controlled by varying conditions such as ionic strength and pH. The differences in charge properties of biological compounds are often considerable, and since ion exchange chromatography is capable of separating species with very minor differences in properties, e.g. two proteins differing by only one charged amino acid, it is a very powerful separation technique.

In ion exchange chromatography one can choose whether to bind the substances of interest and allow the contaminants to pass through the column, or to bind the contaminants and allow the substance of interest to pass through. Generally, the first method is more useful since it allows a greater degree of fractionation and concentrates the substances of interest.

The conditions under which substances are bound (or free) are discussed in detail in the sections dealing with choice of experimental conditions, Chapter 9. In addition to the ion exchange effect, other types of binding may occur. These effects are small and are mainly due to van der Waals forces and non-polar interactions.

Ion exchange separations may be carried out in a column, by a batch procedure or by expanded bed adsorption. All three methodologies are performed in the stages of equilibration, sample adsorption etc. described previously.

The matrix

An ion exchanger consists of an insoluble matrix to which charged groups have been covalently bound. The charged groups are associated with mobile counter-ions. These counter-ions can be reversibly exchanged with other ions of the same charge without altering the matrix.

It is possible to have both positively and negatively charged exchangers (Fig. 2). Positively charged exchangers have negatively charged counter-ions (anions) available for exchange and are called anion exchangers. Negatively charged exchangers have positively charged counter-ions (cations) and are termed cation exchangers.

The matrix may be based on inorganic compounds, synthetic resins or polysaccharides. The characteristics of the matrix determine its chromatographic properties such as efficiency, capacity and recovery as well as its chemical stability, mechanical

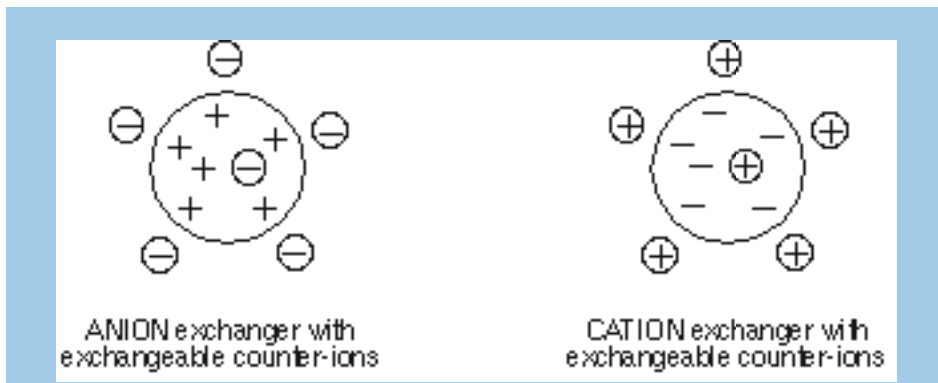

Fig. 2. Ion exchanger types.

strength and flow properties. The nature of the matrix will also affect its behaviour towards biological substances and the maintenance of biological activity.

The first ion exchangers were synthetic resins designed for applications such as demineralisation, water treatment, and recovery of ions from wastes. Such ion exchangers consist of hydrophobic polymer matrices highly substituted with ionic groups, and have very high capacities for small ions. Due to their low permeability these matrices have low capacities for proteins and other macromolecules. In addition, the extremely high charge density gives very strong binding and the hydrophobic matrix tends to denature labile biological materials. Thus despite their excellent flow properties and capacities for small ions, these types of ion exchanger are unsuitable for use with biological samples.

The first ion exchangers designed for use with biological substances were the cellulose ion exchangers developed by Peterson and Sober (2). Because of the hydrophilic nature of cellulose, these exchangers had little tendency to denature proteins. Unfortunately, many cellulose ion exchangers had low capacities (otherwise the cellulose became soluble in water) and had poor flow properties due to their irregular shape.

Ion exchangers based on dextran (Sephadex), followed by those based on agarose (Sepharose CL-6B) and cross-linked cellulose (DEAE Sephacel) were the first ion exchange matrices to combine a spherical form with high porosity, leading to improved flow properties and high capacities for macromolecules. Subsequently, developments in gel technology have enabled this macroporosity to be extended to the highly cross-linked agarose based media such as Sepharose High Performance, Sepharose Fast Flow and Sepharose Big Beads, and the synthetic polymer matrices, MonoBeads, and SOURCE. These modern media enable fast, high capacity, high resolution ion exchange chromatography to be carried out at both analytical and preparative scales. Non-porous polymer matrices, e.g. MiniBeads, are available for extremely high resolution micropreparative or analytical separations.

Charged groups

The presence of charged groups is a fundamental property of an ion exchanger. The type of group determines the type and strength of the ion exchanger; their total number and availability determines the capacity. There is a variety of groups which have been chosen for use in ion exchangers (3); some of these are shown in Table 1.

Table 1. Functional groups used on ion exchangers.

Anion exchangers	Functional group
Diethylaminoethyl (DEAE)	$-\text{O}-\text{CH}_2-\text{CH}_2-\text{N}^+\text{H}(\text{CH}_2\text{CH}_3)_2$
Quaternary aminoethyl (QAE)	$-\text{O}-\text{CH}_2-\text{CH}_2-\text{N}^+(\text{C}_2\text{H}_5)_2-\text{CH}_2-\text{CHOH}-\text{CH}_3$
Quaternary ammonium (Q)	$-\text{O}-\text{CH}_2-\text{CHOH}-\text{CH}_2-\text{O}-\text{CH}_2-\text{CHOH}-\text{CH}_2-\text{N}^+(\text{CH}_3)_3$
Cation exchangers	Functional group
Carboxymethyl (CM)	$-\text{O}-\text{CH}_2-\text{COO}^-$
Sulphopropyl (SP)	$-\text{O}-\text{CH}_2-\text{CHOH}-\text{CH}_2-\text{O}-\text{CH}_2-\text{CH}_2-\text{CH}_2\text{SO}_3^-$
Methyl sulphonate (S)	$-\text{O}-\text{CH}_2-\text{CHOH}-\text{CH}_2-\text{O}-\text{CH}_2-\text{CHOH}-\text{CH}_2\text{SO}_3^-$

Sulphonic and quaternary amino groups are used to form strong ion exchangers; the other groups form weak ion exchangers. The terms strong and weak refer to the extent of variation of ionization with pH and not the strength of binding. Strong ion exchangers are completely ionized over a wide pH range (see titration curves on page 49) whereas with weak ion exchangers, the degree of dissociation and thus exchange capacity varies much more markedly with pH.

Some properties of strong ion exchangers are:

- Sample loading capacity does not decrease at high or low pH values due to loss of charge from the ion exchanger.
- A very simple mechanism of interaction exists between the ion exchanger and the solute.
- Ion exchange experiments are more controllable since the charge characteristics of the media do not change with changes in pH. This makes strong exchangers ideal for working with data derived from electrophoretic titration curves. (see Chapter 9)

Resolution in ion exchange chromatography

This section discusses the main theoretical parameters which affect the separation in ion exchange chromatography. For more in-depth information the reader is referred to standard works on the subject (4, 5).

The result of an ion exchange experiment, as with any other chromatographic separation, is often expressed as the resolution between the peaks of interest.

The resolution (R_S) is determined from the chromatogram as shown in Figure 3.

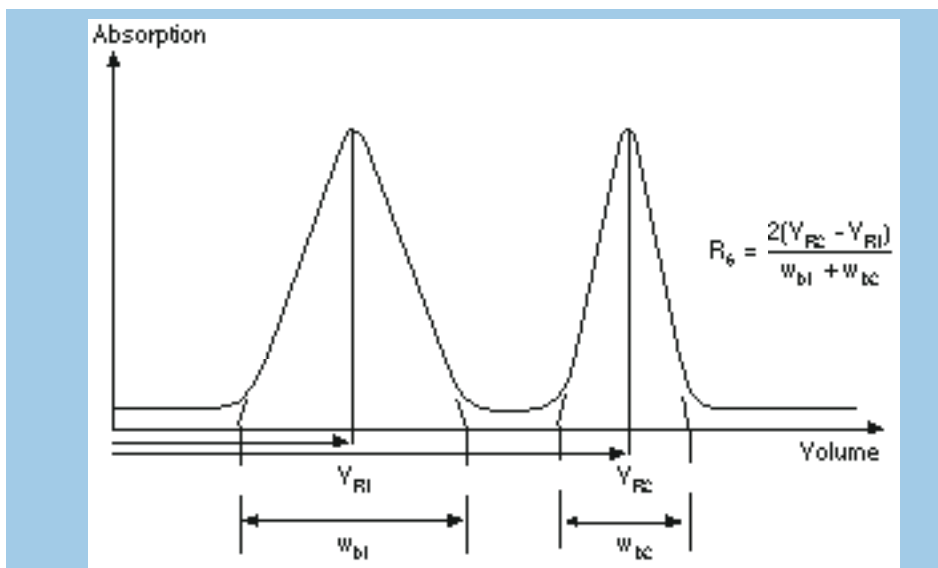

Fig. 3. Determination of the resolution (R_S) between two peaks.

The resolution is defined as the distance between peak maxima compared with the average base width of the two peaks. Elution volumes and peak widths should be measured with the same units to give a dimensionless value to the resolution.

R_S is a measure of the relative separation between two peaks and can be used to determine if further optimization of the chromatographic procedure is necessary. If $R_S = 1.0$ (Fig. 4) then 98% purity has been achieved at 98% of peak recovery, provided the peaks are Gaussian and approximately equal in size. Baseline resolution requires that $R_S \geq 1.5$. At this value purity of the peak is 100%.

Note: A completely resolved peak is not equivalent to a pure substance. This peak may represent a series of components which are not resolvable using the selected separation parameter.

The resolution achievable in a system is proportional to the product of the selectivity, the efficiency and the capacity of the system, the three most important parameters to control in column chromatography. The analytical expression for R_S is:

$$R_S = \underbrace{1/4 \cdot \frac{(\alpha - 1)}{\alpha}}_{\text{selectivity}} \cdot \underbrace{(\sqrt{N})}_{\text{efficiency}} \cdot \underbrace{\frac{k}{(1 + k)}}_{\text{capacity}}$$

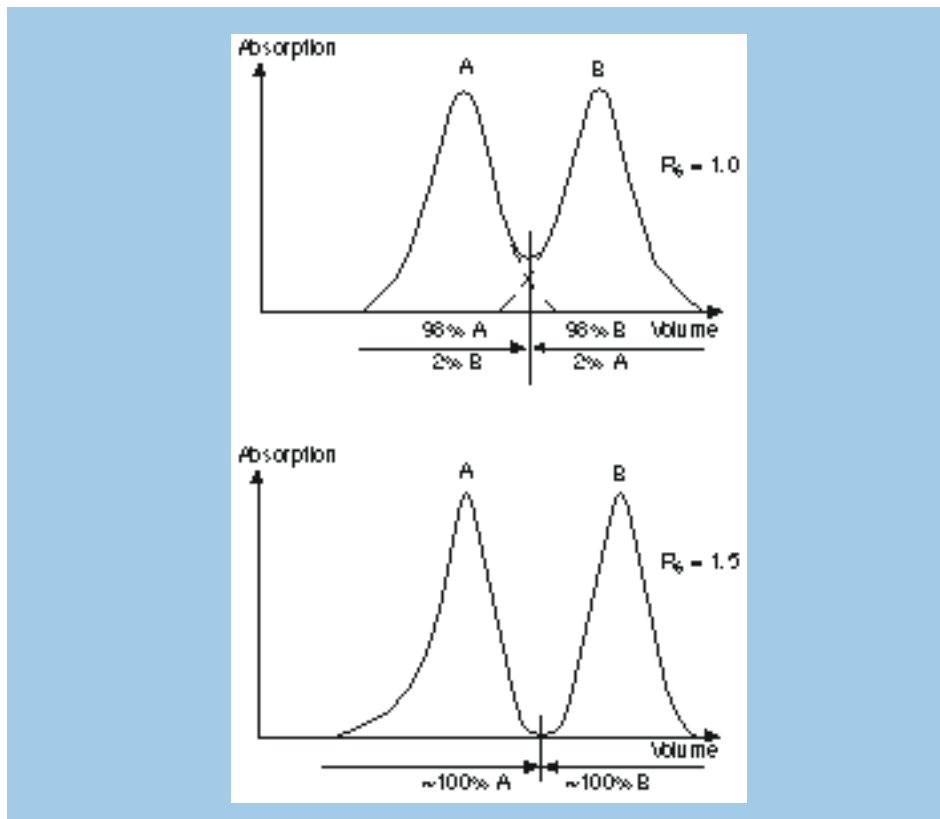

Fig. 4. Separation results with different resolutions.

Capacity factor

The capacity or retention factor k is a measure of the retention of a component and should not be confused with loading capacity (mg sample/ml) or ionic capacity (mmol/ml).

The capacity factor is calculated for each individual peak. For example k for peak 1 in Figure 5 is derived from the equation:

$$\text{capacity factor } k = \frac{V_{R1} - V_t}{V_t}$$

In the equation for R_s , k is the average of k_1 and k_2 .

Adsorption techniques such as ion exchange chromatography can have high capacity factors since experimental conditions can be chosen which lead to peak retention volumes greatly in excess of V_t (V_t is also often denoted V_m). This can

be seen in contrast with the technique of gel filtration where capacity is limited since all peaks must elute within the volume ($V_t - V_0$).

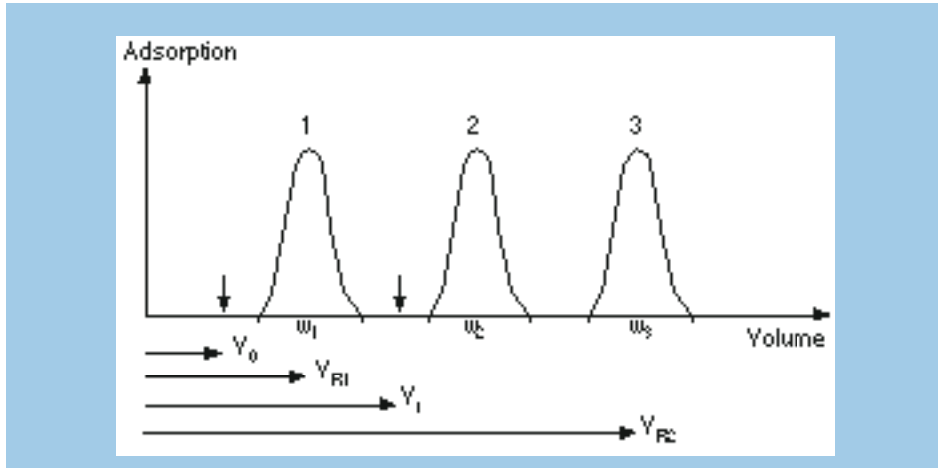

Fig. 5. Hypothetical chromatogram. V_0 = void volume, V_{R1} = elution volume for peak 1, V_{R2} = elution volume for peak 2, V_t = total volume, w_{b1} = peak width for peak 1, w_{b2} = peak width for peak 2.

Efficiency

The column efficiency is related to the zone broadening which occurs on the column and can be calculated from the expression:

$$N = 5.54 \left(\frac{V_{R1}}{w_h} \right)^2 \quad \begin{array}{l} \text{where } w_h \text{ is the peak width} \\ \text{at half peak height} \end{array}$$

and is expressed as the number of theoretical plates (N) for the column under specified experimental conditions. Efficiency is frequently stated as the number of theoretical plates per metre chromatographic bed, or expressed as H (height equivalent to a theoretical plate, HETP), which is the bed length (L) divided by the plate number.

$$H = L/N$$

Since the observed value for N depends on experimental factors such as flow rate and sample loading, it is important that comparisons are done under identical conditions. In the case of ion exchange chromatography, efficiency is measured under isocratic conditions, using a substance which does not interact with the matrix, e.g. acetone.

One of the main causes of zone broadening in a chromatography bed is longitudinal diffusion of the solute molecules. The effect is minimized if the distances available for diffusion, in both the mobile phase and stationary phase, are minimized. In practice this is achieved by using small uniform bead sizes and important developments in ion exchange chromatography have been the introduction of 10 μm and 15 μm diameter particles such as MonoBeads and SOURCE, to give high efficiency preparative media. The highest efficiency is achieved with the non-porous, 3 μm diameter MiniBeads, designed for analytical and micropreparative applications.

After bead size, the second major contributory factor to efficiency is good experimental technique. Badly, unevenly packed chromatography beds and air bubbles will lead to channelling, zone broadening and loss of resolution. Good separations require well packed columns and the importance of column packing increases in direct proportion to the performance required.

Selectivity

The selectivity (α) defines the ability of the system to separate peaks i.e. the distance between two peaks. The selectivity factor can be calculated from the chromatogram (Fig. 5) using the expression

$$\alpha = \frac{k_2}{k_1} = \frac{V_{R2} - V_0}{V_{R1} - V_0} \approx \frac{V_{R2}}{V_{R1}}$$

Good selectivity is a more important factor than high efficiency in determining resolution (Fig. 6) since R_s is linearly related to selectivity but quadratically related to efficiency. This means that a four fold increase in efficiency is required to double the resolution under isocratic conditions.

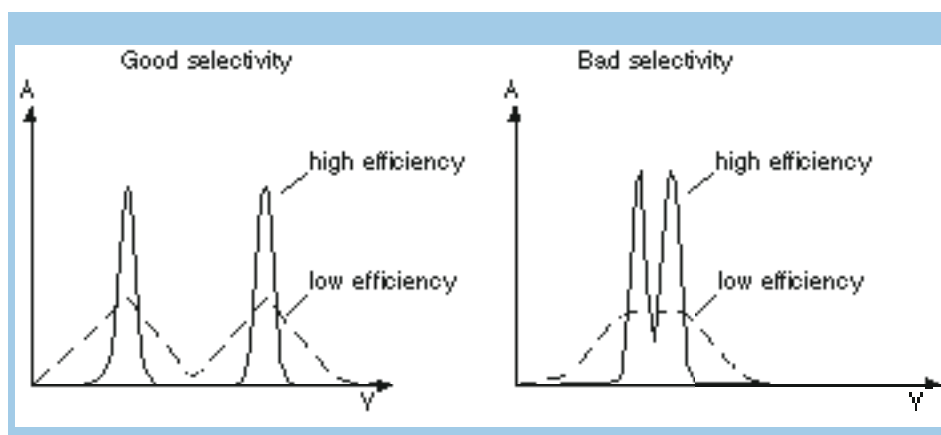

Fig. 6. The effect of selectivity and efficiency on resolution.

Selectivity in ion exchange chromatography depends not only on the nature and number of the ionic groups on the matrix but also on the experimental conditions, such as pH and ionic strength. It is the ease and predictability with which these experimental conditions, and thus the selectivity, can be manipulated which gives ion exchange chromatography the potential of extremely high resolution.

Capacity

The capacity of an ion exchanger is a quantitative measure of its ability to take up exchangeable counter-ions and is therefore of major importance. The capacity may be expressed as total ionic capacity, available capacity or dynamic capacity.

The total ionic capacity is the number of charged substituent groups per gram dry ion exchanger or per ml swollen gel. Total capacity can be measured by titration with a strong acid or base.

The actual amount of protein which can be bound to an ion exchanger, under defined experimental conditions, is referred to as the available capacity for the gel. If the defined conditions include the flow rate at which the gel was operated, the amount bound is referred to as the dynamic capacity for the ion exchanger. Available and dynamic capacities depend upon:

- The properties of the protein.
- The properties of the ion exchanger.
- The chosen experimental conditions.

The properties of the protein which determine the available or dynamic capacity on a particular ion exchange matrix are its molecular size and its charge/pH relationship. The capacity of an ion exchanger is thus different for different proteins.

On a porous matrix used for ion exchange chromatography, molecules which are small enough to enter the pores will exhibit a higher available capacity than those molecules which are restricted to the charged substituents on the surface of the gel.

Similarly, since the interaction is ionic, the protein's charge/pH relationship must be such that the protein carries the correct net charge, at a sufficiently high surface charge density, to be bound to a particular ion exchanger under the chosen buffer conditions.

The properties of the ion exchange matrix which determine its available capacity for a particular protein are the exclusion limit of the matrix, and the type and number of the charged substituents. High available capacity is obtained by having a matrix which is macroporous and highly substituted with ionic groups which maintain their charge over a wide range of experimental conditions. Non-porous

matrices have considerably lower capacity than porous matrices, but higher efficiency due to shorter diffusion distances.

The experimental conditions which affect the observed capacity are pH, the ionic strength of the buffer, the nature of the counter-ion, the flow rate and the temperature. The flow rate is of particular importance with respect to dynamic capacity, which decreases as the flow rate is increased. These conditions should always be taken into consideration when comparing available capacities for different ion exchangers.

Methodologies for determining the available and dynamic capacities for an ion exchanger are given in Chapter 10.

3. Product Guide

Pharmacia Biotech manufactures a wide range of ion exchange media suitable for analytical, micropreparative, small scale preparative, and process scale applications. The product range is summarized below.

MonoBeads (page 23)

Mono Q and Mono S are strong ion exchangers based on MonoBeads, monodisperse 10 μm hydrophilic polymer particles. Mono Q and Mono S are the established standards for high performance ion exchange separations and are best suited for analytical and small scale preparative applications.

MiniBeads (page 30)

MiniBeads, a non-porous matrix of monodisperse 3 μm hydrophilic polymer particles, is the base for two strong ion exchangers, Mini Q and Mini S. Both media are available pre-packed in Precision Columns 3.2/3, for micropreparative chromatography in SMART System. With a specially designed column holder, these columns can also be used in FPLC and HPLC systems.



SOURCE (page 34)

SOURCE 15Q, SOURCE 15S, SOURCE 30Q and SOURCE 30S are strong ion exchangers based on the same type of rigid polymer matrix as MonoBeads, polystyrene/divinyl benzene beads. SOURCE 15Q and SOURCE 15S are based on 15 μm monodisperse particles while SOURCE 30Q and SOURCE 30S are based on 30 μm monodisperse particles. SOURCE ion exchange media are designed for high performance applications at both research and industrial scales. They provide high capacity at high flow rates and at a minimum of back-pressure, thus allowing short cycle times, high productivity and scalability.

SOURCE 15 matrices are ideal for purification when very high resolution (efficiency) is required. SOURCE 30 matrices gives, in comparison with SOURCE 15 matrices, slightly less resolution (lower efficiency) but at much lower back-pressure. This makes SOURCE 30 ideal for purification with more complex samples and larger volumes. Using SOURCE 30, a higher degree of purification can be obtained with high productivity. Typically working flow rate ranges for ion exchangers based on SOURCE 15 and SOURCE 30 are 30-600 cm/h and 300-1000 cm/h respectively.



Sepharose High Performance ion exchangers (page 43)

Q and SP Sepharose High Performance are strong ion exchangers based on a 34 μm highly cross-linked agarose matrix, providing high physical and chemical stability. These media are ideal for intermediate and final purification. They should be used when resolution is the main objective. As resolution and efficiency are maintained with increasing column diameter and sample load, separations using these media are easy to scale up. Typical working flow rates are 50-150 cm/h.



Sepharose Fast Flow ion exchangers (page 46)

Sepharose Fast Flow ion exchangers are based on 90 μm highly cross-linked 6% agarose beads of high chemical and physical stability. The range consists of the weak exchangers DEAE Sepharose Fast Flow and CM Sepharose Fast Flow as well as the strong exchangers Q Sepharose Fast Flow and SP Sepharose Fast Flow. The exceptional flow characteristics make these ion exchangers the first choice for separating crude mixtures early in a purification scheme. Here, fast removal and a combination of good resolution and high flow rate are essential. Typical working flow rates for these media are 100-300 cm/h. Sepharose Fast Flow ion exchangers are ideal for purifications with high demands on productivity.



Sepharose Big Beads ion exchangers (page 50)

Q and SP Sepharose Big Beads are strong ion exchangers designed for industrial applications. They are based on 100-300 μm highly cross-linked 6% agarose beads. The large particle size combined with high physical stability of the base matrix ensures rapid processing, even for viscous samples. Sepharose Big Beads is therefore the choice at the beginning of a purification scheme, where viscosity and back-pressure may limit the throughput attainable with ion exchangers based on smaller bead sizes, such as Sepharose Fast Flow ion exchangers. The medium should be chosen when large volumes are handled and fast adsorption is required and when resolution is of less importance.



STREAMLINE ion exchangers (page 52)

STREAMLINE adsorbents, available as STREAMLINE DEAE and STREAMLINE SP, are specially designed for use in STREAMLINE columns for expanded bed adsorption. Together they enable the high flow rates needed for high productivity in industrial applications of fluidized beds. STREAMLINE adsorbents, based on cross-linked 6% agarose beads with a mean particle size of 200 μm , are designed to handle samples directly from both fermentation homogenates and crude samples from cell culture/fermentation at working flow rates of typically 200-400 cm/h.

DEAE Sepharose CL-6B and CM Sepharose CL-6B (page 54)

DEAE and CM Sepharose CL-6B ion exchangers are based on 90 µm cross-linked 6% agarose beads. These two gels are the traditional agarose based ion exchangers from Pharmacia Biotech. Their performance has been demonstrated in several hundred applications for the separation of proteins, polysaccharides, nucleic acids, membrane components and other high molecular weight substances. Sepharose CL-6B based ion exchangers are typically used with working flow rates of up to 60 cm/h.

DEAE Sephacel (page 58)

DEAE Sephacel is a beaded cellulose ion exchanger for separations over a wide molecular weight range (up to 1×10^6 for globular proteins). DEAE Sephacel is the medium of choice when a cellulose ion exchanger is needed for standard chromatography of proteins, nucleic acids or other biopolymers.

Sephadex ion exchangers (page 61)

Sephadex ion exchangers are bead-formed media based on cross-linked dextran. They are available as strong and weak ion exchangers covering the pH range 2-10. Sephadex ion exchanger are suitable for batch-type applications.

Bulk quantities

All Pharmacia Biotech ion exchangers are available in larger pack sizes or larger pre-packed columns. Contact your local Pharmacia Biotech supplier for further information.

Equipment

Pharmacia Biotech also supply a full range of equipment for operating all of the ion exchangers covered in this handbook. Information regarding specific equipment is available upon request from Pharmacia Biotech.

4. MonoBeads and MiniBeads

MonoBeads

MonoBeads are unique, highly efficient, pH stable ion exchange media, specifically designed for high resolution separations of proteins, peptides, and oligonucleotides. An example of the type of separation which can be achieved is shown in Figure 7.

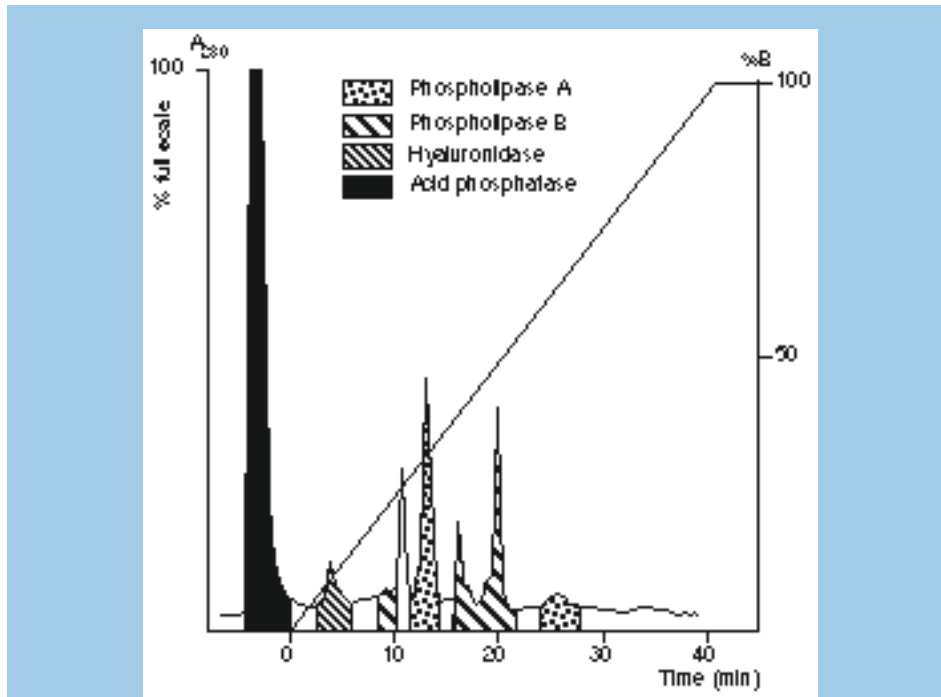

Fig. 7. Characterization of venom from the White Faced Hornet by cation exchange chromatography (6).

Conditions: Venom (7 mg) dissolved in 50 mM BICINE, pH 8.4 (buffer A); Column, Mono S HR 5/5; Buffer B, 0.35 M NaCl in Buffer A; Gradient, 0-100% B in 40 ml; flow rate, 1 ml/min; detection, 280 nm at 0.05 AUFS.

MonoBeads ion exchangers are based on a 10 μ m beaded hydrophilic polystyrene/divinyl benzene resin which has been substituted with quaternary amine groups to yield the strong anion exchanger, Mono Q, or with methyl sulphonate groups to yield the strong cation exchanger, Mono S.

Note: Substitution with the same ionic groups as Polybuffer Exchanger PBE 94 gives Mono P - the matrix used for high resolution chromatofocusing. For further information on the technique and media for chromatofocusing the reader should contact Pharmacia Biotech.

The name MonoBeads is derived from the unique monodisperse nature of the matrix. This monodispersity (Fig. 8) was accomplished through a process developed by Professor John Ugelstad of SINTEF, Trondheim, Norway.

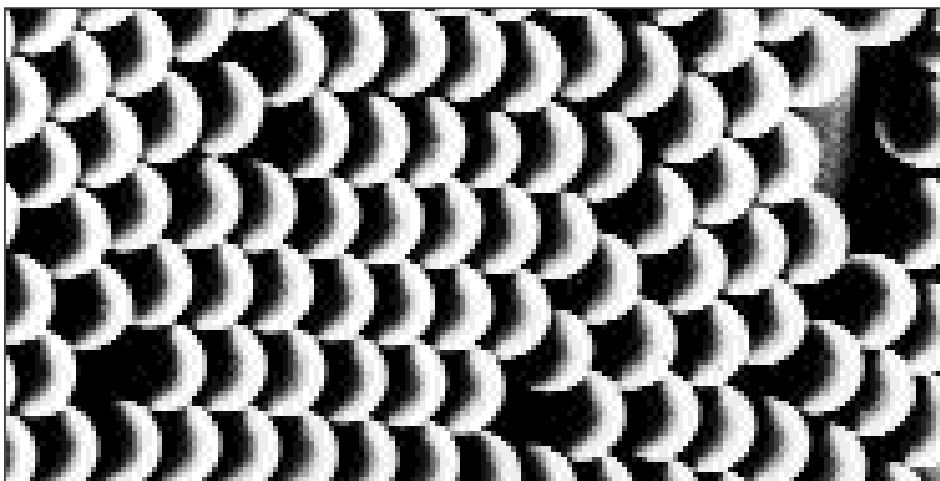

Fig. 8. An electron micrograph of MonoBeads showing their distinct monodispersity.

The resolution which can be achieved on any chromatographic matrix is a result of a combination of the efficiency and selectivity of the system. Maximum efficiency is obtained through the use of small, perfectly spherical, monodisperse particles, optimally packed in a well designed column. All pre-packed MonoBeads columns have efficiencies at about 25 000 plates per metre. High efficiency, coupled with the excellent selectivity of the Q and S substituents, results in high resolution separations.

Scale-up to SOURCE Q and S (see Chapter 5), Q and SP Sepharose High Performance and Q and SP Sepharose Fast Flow (see Chapter 6) is simple, since these gels have similar selectivities to MonoBeads based media.

Properties

Chemical stability

The gels are stable for continuous use in the pH range 2-12, although pH values as high as 14 can be used during cleaning and sanitizing procedures. MonoBeads can be used with solutions of most buffers used in biochemical separations of biomolecules and in water-alcohol (C1 - C4) and acetonitrile-water solutions.

The resistance of the MonoBeads matrix to organic solvents allows complete cleaning and the use of conditions necessary for the solubilization of very hydrophobic samples. An example of the use of MonoBeads with organic solvents is given in Figure 9, which shows the analysis of the peptide bacitracin on Mono S using lithium chlorate as the eluting salt and 90% methanol as the liquid phase (7).

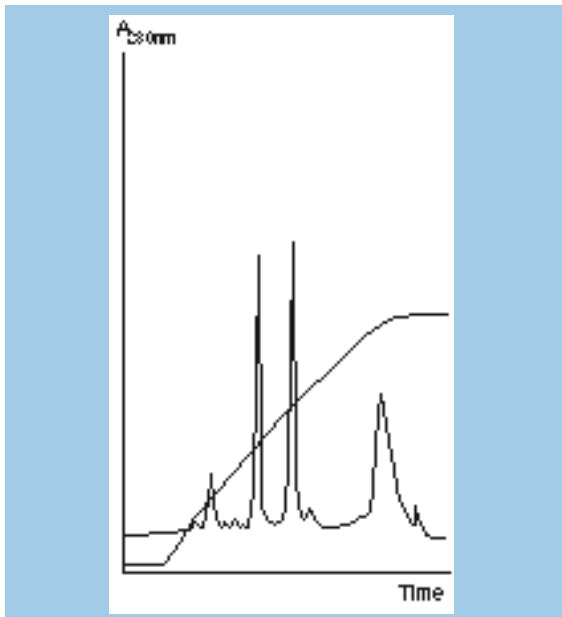

Fig. 9. Separation of the peptide bacitracin on Mono S. (Work by Pharmacia Biotech, Uppsala, Sweden.)

Dimethylsulphoxide (DMSO) and similar solvents can be used, but will change the separation properties of the gels. Aqueous solutions of urea, ethylene glycol and similar compounds can be used but will increase the back-pressures due to their higher viscosities. Non-ionic detergents, zwitterionic detergents or detergents with the same charge as the ion exchange groups may be used. Oxidizing agents should be avoided.

Physical stability

MonoBeads are based on highly rigid beads which means that they can be used at high flow rates. As a consequence of the monodisperse nature of the matrix these high flow rates do not result in high back-pressures. For example, an HR 5/5 column (5 mm inner diameter and 50 mm bed height) packed with a MonoBeads matrix normally generates a back-pressure of 1.0-1.5 MPa (10-15 bar) when operated at a flow rate of 1 ml/min (300 cm/h).

Note: These back-pressures are beyond the operating limits of standard laboratory peristaltic pumps.

A summary of the characteristics of MonoBeads is shown in Table 2.

Table 2. Characteristics of MonoBeads.

Properties	Mono Q	Mono S
Type of gel	strong anion exchanger	strong cation exchanger
Charged group	-O-CH ₂ -CHOH-CH ₂ -O- -CH ₂ -CHOH-CH ₂ -N ⁺ (CH ₃) ₃	-O-CH ₂ -CHOH-CH ₂ -O- -CH ₂ -CHOH-CH ₂ SO ₃ ⁻
Total ionic capacity (µmoles/ml gel)	270-370	140-180
Total protein binding capacity (mg/ml gel)		
Thyroglobulin (MW 669 000)	25	N.D.
HSA (MW 68 000)	65	N.D.
α-lactalbumin (MW 14 300)	80	N.D.
IgG (MW 150 000)	N.D.	75
Ribonuclease (MW 13 700)	N.D.	75
Typical protein recoveries (%)	90-100	90-100
Typical enzyme activity recoveries (%)	>80	>80
Average particle size (µm)	10 ±0.5	10 ±0.5
MW range (proteins)	up to 10 ⁷	up to 10 ⁷
working pH range*	3-11	3-11
pH stability**		
long term	2-12	2-12
short term	2-14	2-14

N.D. = Not determined

Solvent restrictions: The ion exchangers are stable in alcohol/water solutions (C1-C4). 100% dimethyl sulphoxide, dimethylformamide, and formic acid can change the separation properties of the gel.

Avoid oxidizing and reactive reagents. Detergents can be used if they are non-ionic or have the same charge as the gel.

* working pH range refers to the pH range over which the ion exchange groups remain charged and maintain consistently high capacity.

** pH stability, long term refers to the pH interval where the gel is stable over a long period of time without adverse effects on its subsequent chromatographic performance.

pH stability, short term refers to the pH interval for regeneration and cleaning procedures.

Flow rate

The rigid monodisperse nature of the media enables high flow rates to be used on MonoBeads columns. Normal recommended flow rates for high resolution separations are in the range 150 to 600 cm/h for HR 5/5 columns. Higher flow rates can be used during column washing and regeneration.

In addition, the absence of buffering capacity means that buffer exchange and re-equilibration can be executed quickly and with small amounts of buffer. Details of the recommended flow rates to be used on the different columns are given in Table 3.

Capacity

The high substitution levels coupled with the large pore size of the matrix, the exclusion limit for globular proteins is 10^7 , give MonoBeads exchangers high capacities for large proteins as well as for smaller polypeptides and peptides.

Typical saturation capacities are in the range of 60 mg protein per ml of gel and typical sample loading capacities are in the region of 25 mg of protein per ml of gel. Data on the saturation capacities for some specific proteins are given in Table 2.

Table 3. Chromatographic properties of pre-packed columns of MonoBeads.

Properties	PC 1.6/5	HR 5/5	HR 10/10	HR 16/10	BioPilot Column 35/100	BioPilot Column 60/100
Column volume (ml)	0.1	1	8	20	100	300
Column dimensions i.d. x bed height (mm)	1.6x50	5x50	10x100	16x100	35x100	60x100
Recommended working flow rate range (ml/min)	0.01-0.40	0.5-2.0	up to 6	up to 10	up to 32	up to 94
Max operating pressure (MPa)	5	5	4	3	2	2
Number of theoretical plates per meter (N/m)	25 000	25 000	25 000	25 000	25 000	25 000
Normal separation times (min)	5-20	5-20	40	40	60-90	60-90

The titration curves for Mono Q and Mono S (Fig. 10) show no buffering capacity which means that the loading capacity does not vary with pH over the working range of the gel.

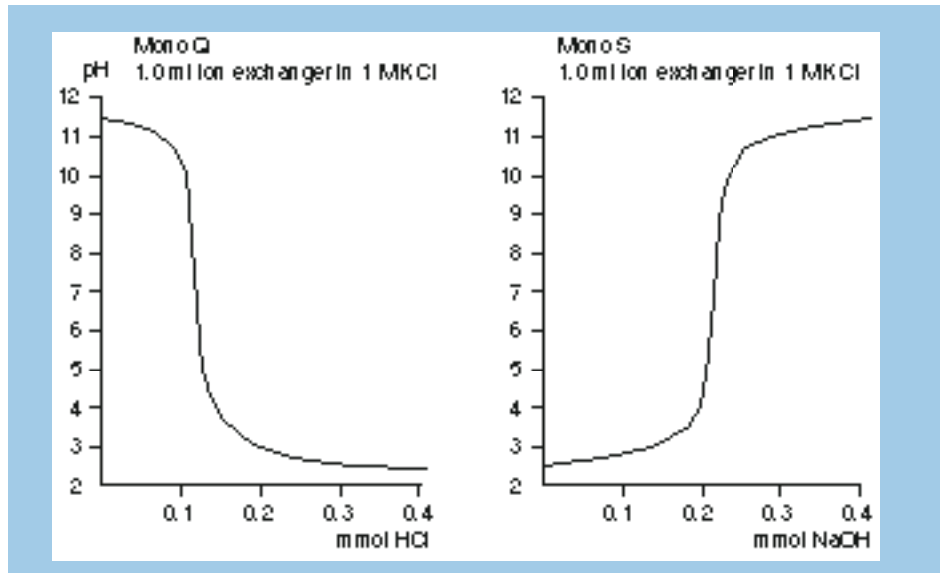

Fig. 10. Titration curves for Mono Q and Mono S. (Work by Pharmacia Biotech, Uppsala, Sweden.)

Recovery

Non-specific interactions to the MonoBeads matrix are very low and consequently recoveries are high. Recoveries of protein mass are typically 90-100% and of protein activity greater than 80%. Examples of protein activity recoveries are shown in Table 4.

Table 4. Protein activity recoveries (%) from MonoBeads columns.

Protein	Mono Q	Mono S
β -Glucuronidase	106	N.D.
β -Glucosidase	N.D.	93
Phosphodiesterase	80	N.D.
Creatine Kinase	90	N.D.
Enolase	N.D.	95
Lactate Dehydrogenase	N.D.	102
Aldolase	N.D.	94

N.D. = Not determined

Reproducibility

The stability of the MonoBeads matrix together with controlled synthesis and column packing procedures ensure very reproducible separations both over time and from column to column. Figure 11 shows the reproducibility of a separation performed on three different Mono S columns.

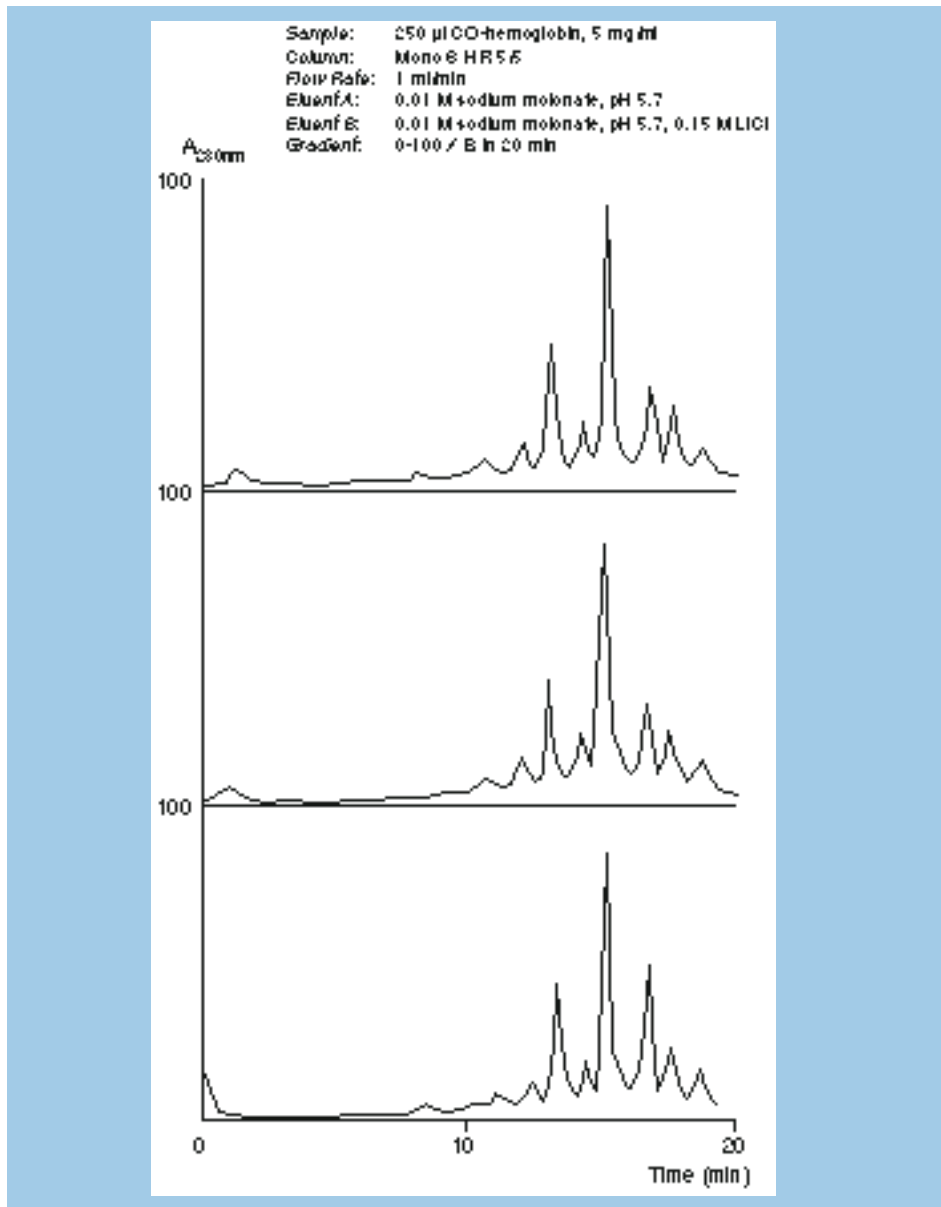

Fig. 11. Reproducible separations on three Mono S HR 5/5 columns. (Work by Pharmacia Biotech, Uppsala, Sweden.)

Availability

Mono Q and Mono S are available pre-packed in columns HR 5/5, HR 10/10 and HR 16/10, containing 1, 8 and 20 ml of gel respectively. The media are also available in BioPilot Columns 35/100 and 60/100 containing respectively 100 and 300 ml bed volumes, for chromatography at BioPilot scale. MonoBeads ion exchangers are also available as Mono Q PC 1.6/5 and Mono S PC 1.6/5, pre-packed columns specially designed for micropurification on SMART System. These columns can also be used in other high performance chromatography systems by using a column holder for Precision Columns. For further information about the column holder, please contact your Pharmacia Biotech representative. For ordering information, see Chapter 14.

MiniBeads

MiniBeads is the base matrix for 3 μm high resolution ion exchange media. This non-porous matrix, consisting of monodisperse hydrophilic polymer beads is substituted with Q and S functional groups to give Mini Q and Mini S. Both media are packed in Precision Columns 3.2/3 (3.2 mm inner diameter and 30 mm bed height) for micropreparative chromatography on SMART System. With a specially designed column holder, these columns can also be used in FPLC and HPLC systems.

MiniBeads are highly efficient pH-stable adsorbents designed for high performance micropurification of proteins, peptides and polynucleotides. The monodispersity permits the use of high flow rates at relatively low back-pressures. The main properties are listed in Table 5.

Due to the smaller particle size, Mini Q and Mini S give faster separations with higher resolution of peaks than ion exchangers based on MonoBeads, see Figure 12. This resolution is crucial for success when separating complex samples in the pg to μg micropreparative scale.

Sample: Chymotrypsinogen A, Ribonuclease A, Cytochrome C, Lysozyme (6:10:6:5), 25 µg/ml gel (6 µg Mini S, 2.5 µg Mono S)
Buffer A: 20 mM acetic acid, pH 5.0
Buffer B: Buffer A with 0.5 M lithium chloride
Gradient: 0–100% B in 20 col. vols. (6 min Mini S, 10 min Mono S).
Flow rate: 10 cm/min (800 µl/min Mini S, 200 µl/min Mono S)
Instrument: SMART System with µPeak Monitor

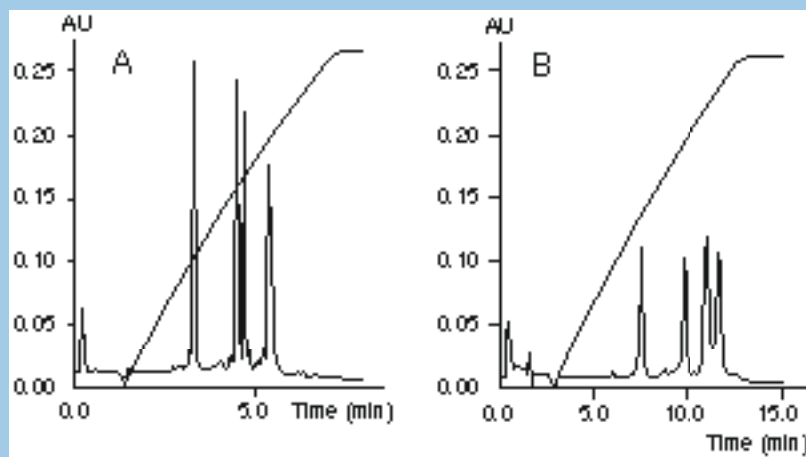

Fig. 12. Comparison of (A) Mini S PC 3.2/3 and (B) Mono S PC 1.6/5. Mini S PC 3.2/3 gives a faster separation and a better resolution of the peaks. Similar results have been found with Mini Q PC 3.2/3 and Mono Q PC 1.6/5. (Work by Pharmacia Biotech, Uppsala, Sweden.)

Properties

Chemical stability

MiniBeads may be used in aqueous solutions and nearly all organic solutions commonly used in chromatography of proteins, oligonucleotides and peptides. As examples, the matrix is stable to 100% acetonitrile, 75% acetic acid, 2 M NaOH and 1 M HCl. Dimethylsulphoxide (DMSO), dimethylformamide, and formic acid and similar solvents will change the separation properties of the gels. Aqueous solutions of urea, ethylene glycol and similar compounds can be used but will increase the back-pressure due to their higher viscosities. Non-ionic detergents, zwitterionic detergents or detergents with the same charge as the ion exchange groups may be used. Oxidizing agents should be avoided.

Physical stability

The combination, non-porous and monodisperse beads gives MiniBeads very high physical stability. It has better flow kinetics and can withstand higher back-pressure (up to 10 MPa) than MonoBeads.

Note: These back-pressures are beyond the operating limits of standard laboratory peristaltic pumps.

Table. 5. Main properties of Mini Q PC 3.2/3 and Mini S PC 3.2/3.

Properties	Mini Q PC 3.2/3	Mini S PC 3.2/3
Type of gel	strong anion exchanger	strong cation exchanger
Charged group	-O-CH ₂ -CHOH-CH ₂ -O- -CH ₂ -CHOH-CH ₂ -N ⁺ (CH ₃) ₃	-O-CH ₂ -CHOH-CH ₂ -O- -CH ₂ -CHOH-CH ₂ SO ₃ ⁻
Total ionic capacity (μmoles/ml gel)	60-90	16-30
Column dimensions i.d. x bed height (mm)	3.2 x 30	3.2 x 30
Column volume (ml)	0.24	0.24
Average particle size (μm)	3 μm	3 μm
Binding capacity (mg/column)		
α-amylas (MW 49 000)	≈ 1.4	N.D.
Trypsin inhibitor (MW 20 100)	≈ 1.4	N.D.
Ribonuclease (MW 13 700)	N.D.	≈ 1.3
Lysozyme (MW 14 300)	N.D.	≈ 1.3
Max loading capacity (mg/column)	1-1.5	1-1.5
Practical loading capacity (μg/column)	≤200	≤200
Typical protein recoveries (%)	70-90	70-90
working pH range*	3-11	3-11
pH stability**		
long term	3-11	3-11
short term	1-14	1-14
Maximum flow rate (ml/min)	1.0	1.0
Operational pressure limit (MPa)	10	10
Normal separation times (min)	5-20	5-20

N.D. = Not determined

* working pH range refers to the pH range over which the ion exchange groups remain charged and maintain consistently high capacity.

** pH stability, long term refers to the pH interval where the gel is stable over a long period of time without adverse effects on its subsequent chromatographic performance.

pH stability, short term refers to the pH interval for regeneration and cleaning procedures.

Reproducibility

Figure 13 shows a long life test and reproducibility test on Mini S PC 3.2/3. Long life and reproducibility are a result of the stable nature of MiniBeads together with controlled synthesis and column packing procedures.

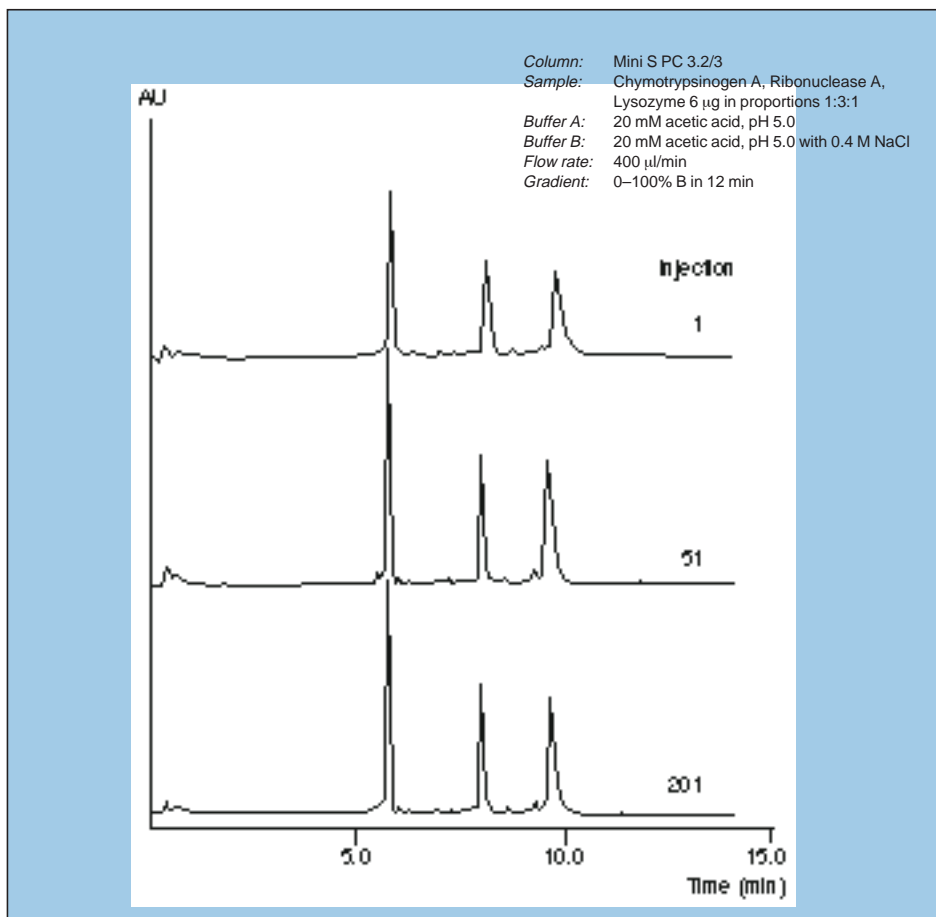

Fig. 13. Long life test on Mini S PC 3.2/3. The chromatograms show the 1st, 5th and 201st separation of a series run on the same column. The same consistently good stability and reproducibility have been confirmed on Mini Q PC 3.2/3 (data not shown here). (Work by Pharmacia Biotech, Uppsala, Sweden.)

Availability

Mini Q and Mini S are available pre-packed in Precision Columns 3.2/3. For ordering information, see Chapter 14.

5. SOURCE

SOURCE ion exchangers are high performance media for fast and high resolution separations of biomolecules such as proteins, peptides and oligonucleotides. Examples are given in Figure 14, 18 and Figure 19.

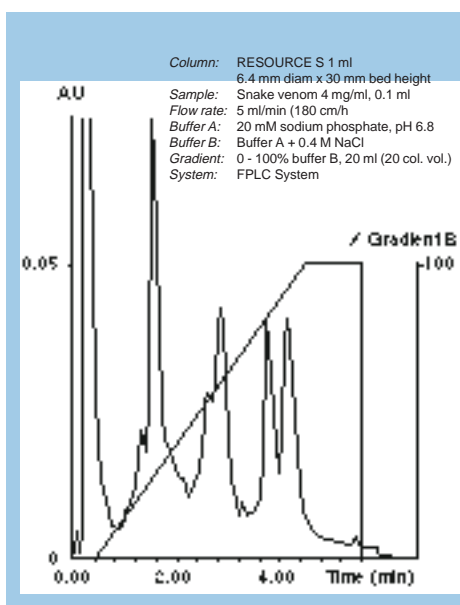

SOURCE media are available in two particle sizes, 15 and 30 μm , and as anion and cation exchangers. The strong anion exchangers SOURCE 15Q and 30Q are produced by substitution of the base matrices with quaternary amino groups. For the strong cation exchangers, SOURCE 15S and 30S, the matrices have been substituted with methyl sulphonate groups. Table 6 summarizes the general properties of SOURCE ion exchangers.

Fig. 14. An example of a fast and high resolution separation on SOURCE. (Work by Pharmacia Biotech, Uppsala, Sweden.)

SOURCE is based on monodisperse, hydrophilized and rigid polystyrene/divinyl benzene beads with controlled pore structure. The beads have a uniform size distribution, see Figure 15, and allow perfect packing of stable chromatography beds. Monodispersity together with the absence of broken beads and fine particles give low operating back-pressures.



Fig. 15. Light microscope photograph of SOURCE. Note the uniform size distribution and absence of broken beads and bead fragments.

Table 6. Characteristics of SOURCE 15Q and 15S, and SOURCE 30Q and 30S.

Properties	SOURCE 15Q	SOURCE 30Q	SOURCE 15S	SOURCE 30S
Type of gel	strong anion exchangers		strong cation exchangers	
Charged group	-O-CH ₂ -CHOH-CH ₂ -O- -CH ₂ -CHOH-CH ₂ -N ⁺ (CH ₃) ₃		-O-CH ₂ -CHOH-CH ₂ -O- -CH ₂ -CHOH-CH ₂ SO ₃ ⁻	
Matrix	Polystyrene/divinyl benzene			
Bead form	Rigid, spherical, porous monodisperse			
Mean particle size (µm)	15	30	15	30
Dynamic binding capacity* (mg/ml gel)				
Lysozyme (MW 14 500)	N.D.	N.D.	80	80
BSA (MW 67 000)	45	45	N.D.	N.D.
MW range (proteins)	up to 10 ⁷	up to 10 ⁷	up to 10 ⁷	up to 10 ⁷
working pH range**	2-12	2-12	2-12	2-12
pH stability***				
long term	2-12	2-12	2-12	2-12
short term	1-14	1-14	1-14	1-14
Maximum flow rate (cm/h)	1800 ¹	2000 ²	1800 ¹	2000 ²
Recommended working flow rate range (cm/h)	30-600	300-1000	30-600	300-1000
Operating temperature (°C)	4-40	4-40	4-40	4-40

N.D. = Not determined

Solvent restrictions: SOURCE is stable in alcohol/water solutions (C1-C4). 100% dimethyl sulphoxide, dimethylformamide, and formic acid can change the separation properties of the gel. Avoid oxidizing and reactive reagents. Detergents can be used if they are non-ionic or have the same charge as the gel.

* Determined by frontal analysis at a flow rate of 300 cm/h, using a 5.0 mg/ml solution of protein in 20 mM sodium phosphate buffer, pH 6.8 (lysozyme) and 20 mM BIS TRIS PROPANE buffer, pH 7.0 (BSA).

** working pH range refers to the pH range over which the ion exchange groups remain charged and maintain consistently high capacity.

*** pH stability, long term refers to the pH interval where the gel is stable over a long period of time without adverse effects on its subsequent chromatographic performance.

pH stability, short term refers to the pH interval for regeneration and cleaning procedures.

1) Maximum flow rate to be applied, will depend on the pressure specification of the chromatographic system used. A linear flow rate of 1800 cm/h will give a pressure drop of approximately 10 MPa at a bed height of 3 cm.

2) Maximum flow rate to be applied, will depend on the pressure specification of the chromatographic system used. A linear flow rate of 2000 cm/h will give a pressure drop of approximately 10 MPa at a bed height of 10 cm.

A uniquely wide pore size distribution and a large specific surface area offer excellent resolution and capacity for a wide range of molecules; from small peptides and oligonucleotides up to large proteins. The performance is well maintained at high flow rates and high sample loads. This is illustrated in Figure 16 and 17, which show separations of model protein mixtures on SOURCE 30Q.

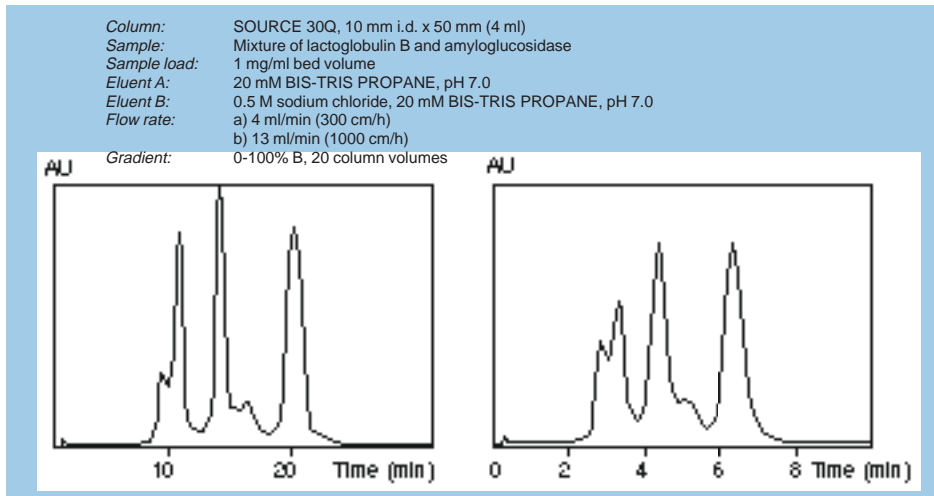

Fig. 16. The influence of increasing flow rate on resolution. (Work by Pharmacia Biotech, Uppsala, Sweden.)

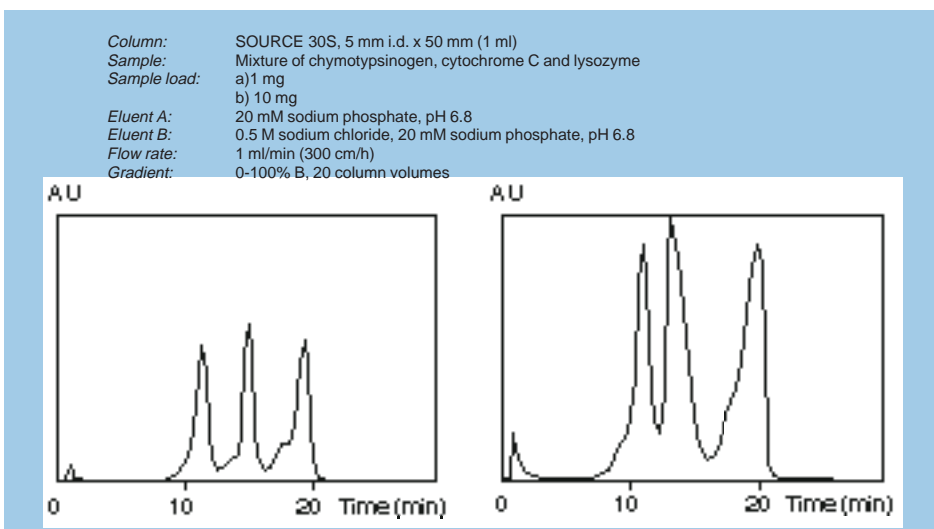

Fig. 17. The influence of increasing sample load on resolution. (Work by Pharmacia Biotech, Uppsala, Sweden.)

SOURCE 15 and SOURCE 30 ion exchangers are designed for research and industrial applications, with emphasis on high performance, high capacity, high reproducibility, and easy scalability.

In comparison with media based on SOURCE 15 matrix, SOURCE 30 gives slightly less resolution (lower efficiency) but at much lower back-pressure. This makes SOURCE 30 ideal for purifications with more complex samples and larger volumes. Using SOURCE 30, a high degree of purification can be obtained with

high productivity. SOURCE 15 matrices are ideal for purification when very high resolution (efficiency) is required.

SOURCE 15 media are available in pre-packed RESOURCE columns. These columns are convenient for lab research applications and method development.

Properties

Chemical stability

The hydrophilized polymeric matrix has high chemical stability and can be used over a wide pH range allowing flexibility in the choice of conditions for separation.

The wide pH stability range, 1-14, allows cleaning and sanitization with harsh agents like 1 M NaOH. Additionally, in applications such as the purification of synthetic oligonucleotides, the wide pH stability also allows use of a high pH buffer to prevent aggregation, see Figure 18.

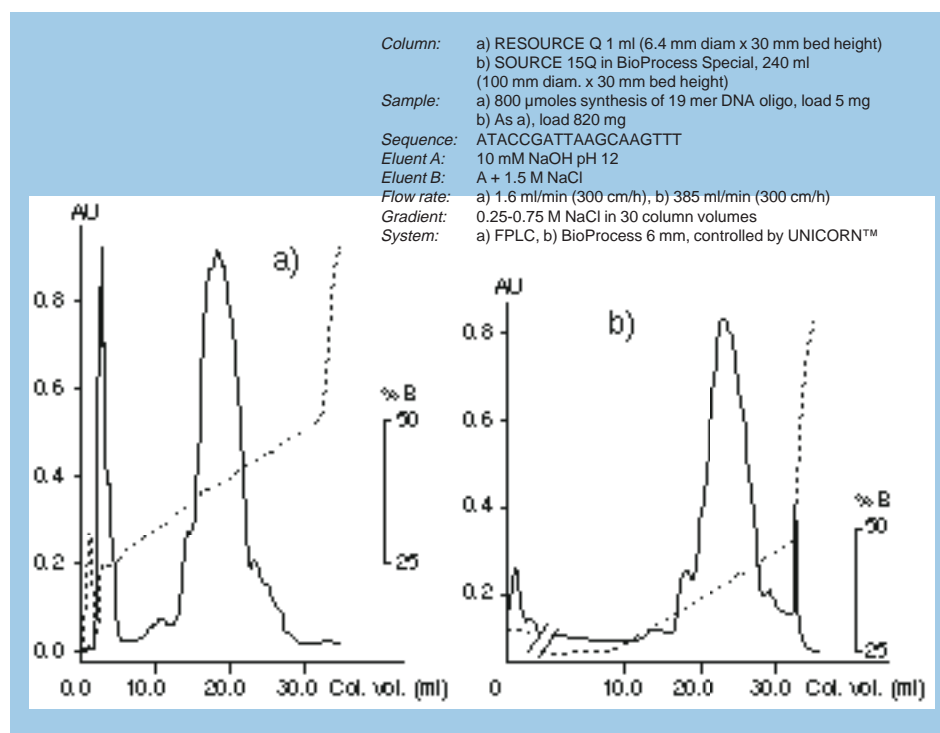

Fig. 18. Purification of 19 mer DNA oligonucleotide on RESOURCE Q 1 ml scaled up to BioProcess Special column 100 mm diameter. Separation optimized for sample load, yield and purity of product. (Work by Pharmacia Biotech, Uppsala, Sweden.)

Flow rate

SOURCE media are based on highly rigid beads which allows use at high flow rates. As a consequence of the monodisperse nature of the matrix, these high flow rates do not result in high back-pressures. The back-pressure from SOURCE media is much lower than for other media of the same particle size range. The low back-pressure offers the advantage of being able to run at very high flow rates on medium pressure equipment, as well as with acceptable flow rates on low pressure equipment. As an example, when a RESOURCE 1 ml column is used at the maximum flow rate of FPLC or HPLC systems (about 10 ml/min, 1800 cm/h) separations are completed in less than 3 minutes, see Figure 19. At flow rates of 1 ml/min (180 cm/h) the extremely low back-pressures (typically around 0.1 MPa, 1 bar, 15 psi) allow high resolution separations in about 20 minutes with systems based only on a peristaltic pump, see Figure 20.

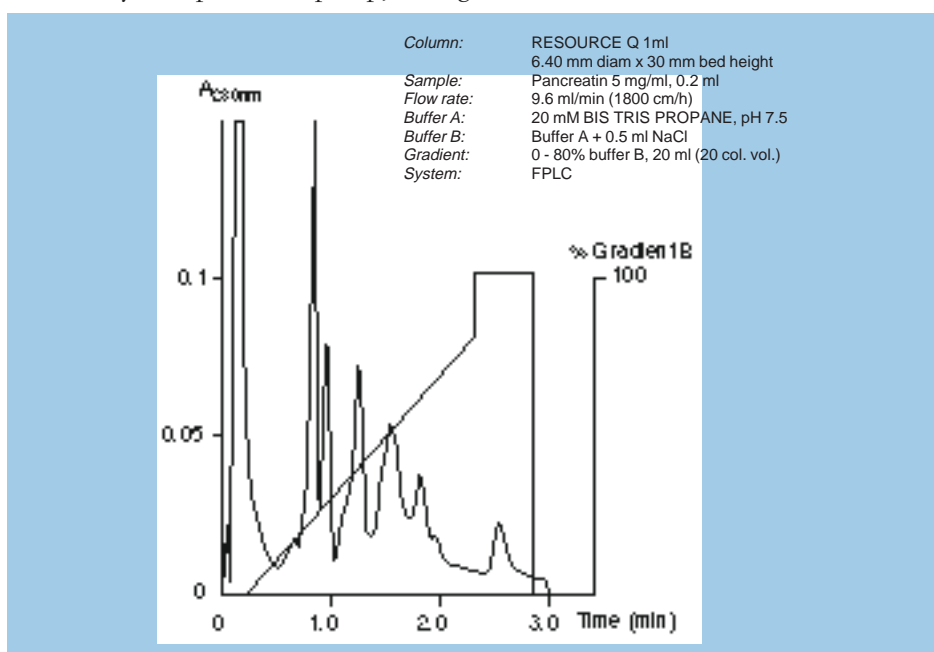

Fig. 19. Separation of pancreatin (Sigma) on RESOURCE Q 1 ml at 9.6 ml/min (1800 cm/h). System: FPLC. (Work by Pharmacia Biotech, Uppsala, Sweden.)

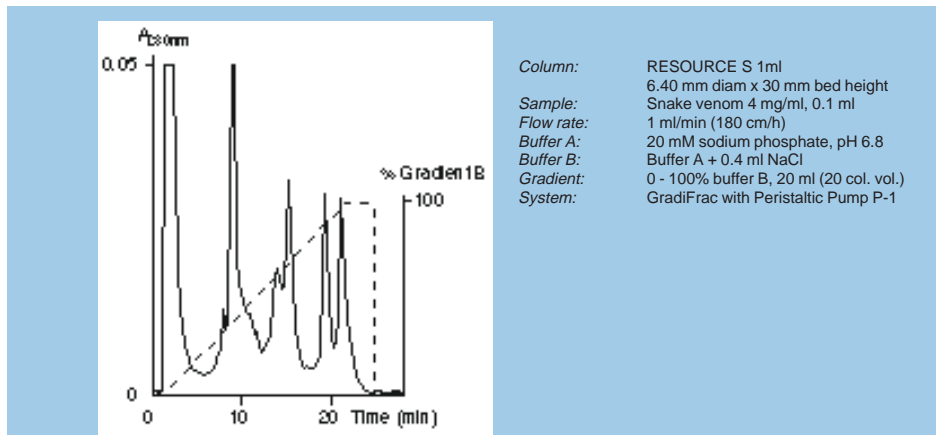

Fig. 20. Separation of snake venom (Sigma) on RESOURCE S 1 ml at 1.0 ml/min (180 cm/h). System: GradiFrac equipped with Peristaltic Pump P-1. Although high performance separations with RESOURCE Q and S do not put special demands on the pump, resolution obtained on the column can be lost through mixing in dead spaces. Low dead volumes, accurate gradient generation, and a good detector and fraction collector are also essential for good results. (Work by Pharmacia Biotech, Uppsala, Sweden.)

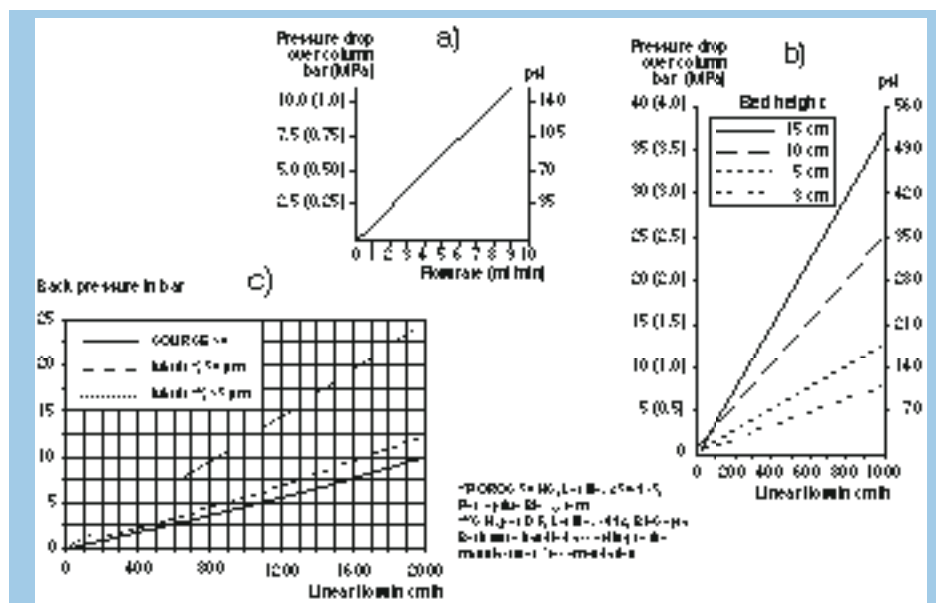

Fig. 21. Pressure versus flow rate curves that can be expected with SOURCE media. Curve in a) shows that RESOURCE 1 ml columns can be used with high pressure equipment or peristaltic pumps. The curves in b) are from a large scale column packed with SOURCE 15 media to 4 different bed heights. Curve c) shows the flow characteristics of the monosized SOURCE 30 matrix compared with polysized media with mean diameters of 35 and 50 μm respectively. The pressure flow data were determined in a 100 mm i.d. column with a bed height of 10 cm. (Work by Pharmacia Biotech, Uppsala, Sweden.)

POROS is a registered trademark of Perceptive Biosystems.
 SHyperD F is a registered trademark of BioSeptra.

Recommended flow rates for high resolution separations are in the range 30 to 600 cm/h for SOURCE 15Q and 15S and 300 to 1000 cm/h for SOURCE 30Q and 30S.

Figure 21 shows pressure versus flow rate characteristics of SOURCE 15 and SOURCE 30.

Capacity

SOURCE ion exchangers have high capacities for large proteins as well as for smaller polypeptides, peptides and oligonucleotides. This is a result of an optimized pore size distribution, a high substitution level and a large binding surface area. Figure 22 shows breakthrough curves at different flow rates on RESOURCE Q and RESOURCE S.

SOURCE Q and S retain their charge and can therefore be used over a wide pH range, 2-12, without variation in loading capacity.

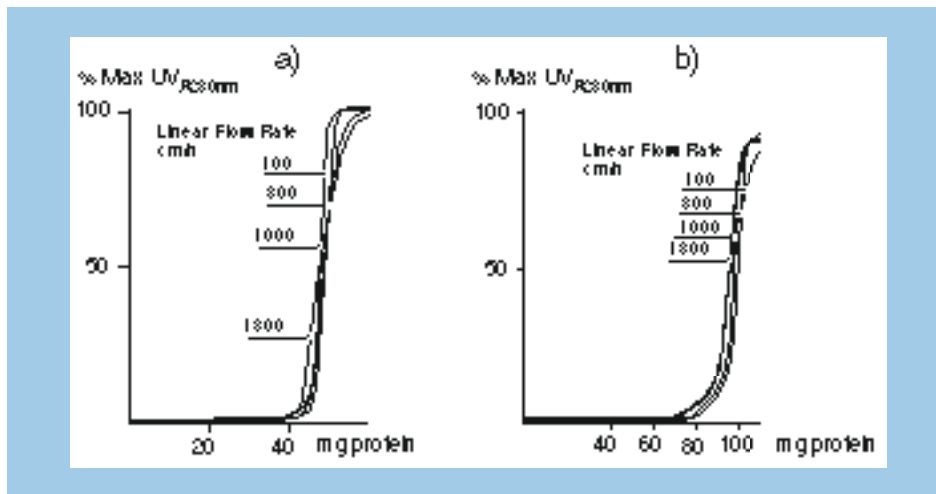

Fig. 22. Breakthrough curves at different flow rates (superimposed).
a) RESOURCE Q 1 ml. Sample: Bovine serum albumin (Sigma), 5 mg/ml.
b) RESOURCE S 1 ml. Sample: Lysozyme, 5 mg/ml (Sigma).
(Work by Pharmacia Biotech, Uppsala, Sweden.)

Recovery

The recovery of protein mass is typically 90-100%. In the application described in Chapter 12, purification of exotoxin A, the recovery in the SOURCE 30Q step was 91%.

Reproducibility

Emphasis during development has been on quality, reproducibility and scalability, features which are particularly important for industrial applications under strict regulatory control. Through the combination of high quality assurance standards and a patented manufacturing process, the particle structure is consistent both bead-to-bead and batch-to-batch. Modal particle diameter varies between batches within $\pm 1 \mu\text{m}$ for SOURCE 15 and $\pm 2 \mu\text{m}$ for SOURCE 30. The reproducibility of a separation of a standard protein mixture performed on four different production batches of SOURCE 30S, see Figure 23, is an example that reflects the reproducible qualities of SOURCE media.

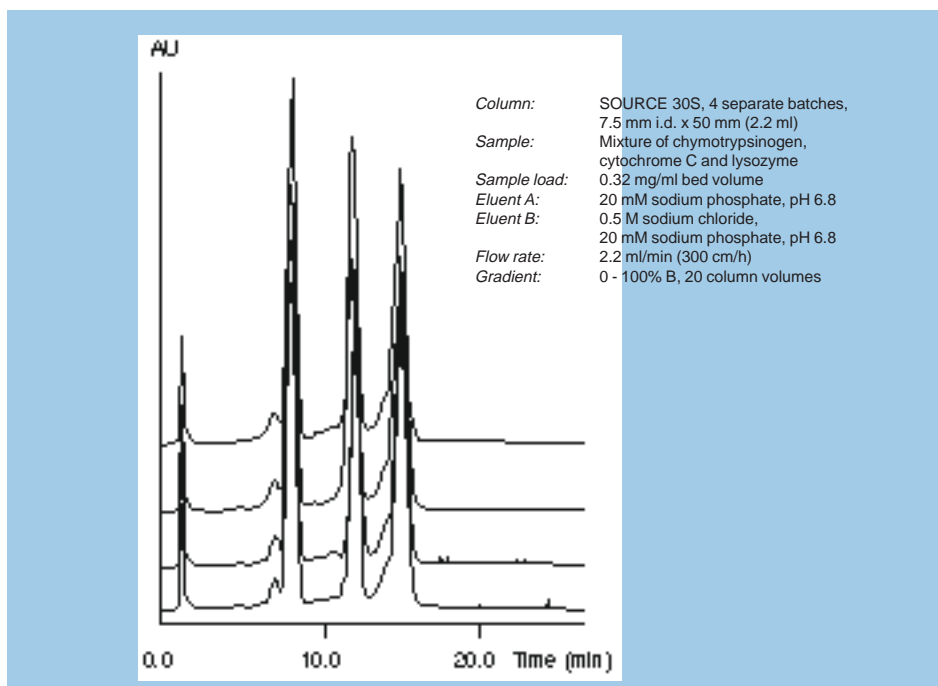

Fig. 23. Quality control evaluation of 4 production batches of SOURCE 30S. (Work by Pharmacia Biotech, Uppsala, Sweden.)

Availability

SOURCE 15Q and 15S are available in pack sizes of 10 ml, 50 ml, 200 ml, 500 ml and 1 litre. SOURCE 30Q and 30S are available in pack sizes of 10 ml, 50 ml, 200 ml, 1 litre, and 5 litres.

RESOURCE Q and S are pre-packed columns with SOURCE 15Q and 15S respectively. They are available in 1 and 6 ml sizes, packed to a bed height of 3 cm. For ordering information please refer to Chapter 14.

6. Sepharose based ion exchangers

Pharmacia Biotech offers a range of ion exchange media based on agarose, which is cross-linked to produce Sepharose High Performance, Sepharose Fast Flow, Sepharose Big Beads, Sepharose CL-6B and STREAMLINE base matrices. Exchanger groups are attached to the gels by stable ether linkages to the monosaccharide units to give the final ion exchange gels.

The polysaccharide chains of Sepharose based ion exchangers are arranged in bundles (Fig. 24). These bundles are further strengthened by different degrees of intra-chain cross-linking which provide a high matrix rigidity. The resulting structure is macroporous and the capacity of the gels very good for globular proteins up to 10^6 in molecular weight.

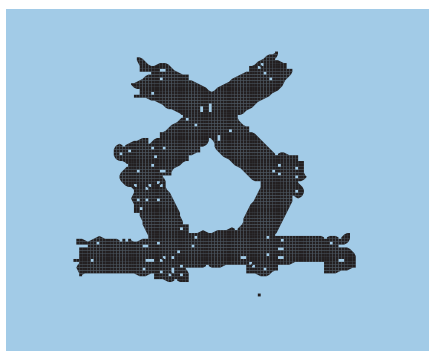

The gels, particularly the most highly cross-linked forms, e.g. Sepharose Fast Flow and Sepharose High Performance ion exchangers, have good flow properties and stable bed volumes that are largely insensitive to changes in ionic strength and pH. They also show extremely low non-specific adsorption of macromolecules (8).

Fig. 24. Structure of cross-linked agarose gels.

Chemical stability

Sepharose ion exchangers tolerate extreme working conditions of temperature, pH and chemical agents. They are stable in water, salt solutions, and organic solvents. Details on the pH stability range for each gel is given in the appropriate section below.

The ion exchangers can be used in solutions of non-ionic detergents such as Triton X-100[®] and with strongly dissociating solvents such as 8 M urea and 6 M guanidine hydrochloride (9). The Sepharose based ion exchangers also tolerate 1 M acetic acid, 30% isopropanol, 30% acetonitrile, 70% ethanol and 1 M NaOH. Under oxidizing conditions, limited hydrolysis of the polysaccharide chains may occur.

The gel-forming fibres of agarose are stiff bundles of polysaccharide chains rather than flexible single chains (10). For this reason the water in the gel can be replaced by other solvents with relatively little effect on pore size. Sepharose ion exchangers

Triton[®] is a registered trademark of Rohm and Haas Co.

can be used in polar organic solvents and in aqueous/organic mixtures. The gel matrix is stable in a wide variety of solvents including ethanol, dimethylformamide, tetrahydrofuran, acetone, dimethylsulphoxide, chloroform, dichloromethane, dichloroethane and dichloroethane/pyridine (50:50).

Sepharose is very resistant to microbial attack due to the presence of the unusual sugar, 3,6-anhydro-L-galactose. However, most buffers can support bacterial growth and so an antimicrobial agent should be used in storage (see page 103).

Physical stability

The highly cross-linked structure of the modern Sepharose based ion exchangers, e.g. Sepharose Fast Flow and Sepharose High Performance, not only gives them increased chemical stability but also results in improved physical stability. This improves flow properties enormously compared to Sepharose CL-6B gels. Cross-linking prevents fluctuations in bed volume under conditions of increasing ionic strength. Thus Sepharose ion exchangers can be regenerated and re-equilibrated repeatedly in the column. Repacking between experiments is thus eliminated, improving reproducibility.

Sepharose ion exchangers can be used at temperatures up to 70 °C and can be sterilized repeatedly in the salt form by autoclaving at 121 °C, pH 7, for 30 minutes.

Sepharose High Performance ion exchangers

Sepharose High Performance ion exchange media are based on 34 µm highly cross-linked agarose beads. The small bead size gives the media high efficiency, which in combination with high selectivity offers the possibility of high resolution standard chromatography separations.

In addition, the use of identical functional groups to those used in Q and SP Sepharose Fast Flow, Mono Q and Mono S and SOURCE Q and SOURCE S media, at comparable substitution levels (i.e. same selectivity), simplifies scaling up from FPLC and up to BioPilot and BioProcess scales.

Properties

Physical stability

The high degree of cross-linking of Sepharose High Performance renders the media extremely stable physically. The high rigidity of the cross-linked agarose matrix eliminates volume variations due to changes in pH or ionic strength.

Capacity

As is the case with all ion exchangers, the capacity depends upon the accessibility of the charged groups and their number. Sepharose High Performance gels have an exclusion limit of approximately 4×10^6 and are highly substituted with strong ion exchange groups. Thus they remain charged and maintain consistently high capacities for proteins over a broad working pH range (Table 7). This allows the selection of a pH value and buffer that best suit the properties of the sample. Titration curves for Q and SP Sepharose High Performance are similar to those for Q and SP Sepharose Fast Flow, which are shown in Figure 26.

Capacity varies from case to case depending on protein properties and flow rate. As an example, the dynamic capacity for human serum albumin on Q Sepharose High Performance is approximately 70 mg per ml gel at 150 cm/h (start buffer 20 mM Tris, pH 8.2). The dynamic capacity for ribonuclease on SP Sepharose High Performance has been estimated to 55 mg/ml gel at 150 cm/h (start buffer 0.1 M sodium acetate, pH 6.0). The characteristics of the media are shown in Table 7. Characteristics specific for HiLoad, HiTrap and BioPilot columns pre-packed with Q and SP Sepharose High Performance are shown in Table 8.

Table 7. Characteristics of Q and SP Sepharose High Performance.

Product	Q Sepharose High Performance	SP Sepharose High Performance
Type of gel	strong anion	strong cation
Total ionic capacity (µmol/ml gel)	140-200	140-200
Dynamic binding capacity* (mg/ml gel)		
BSA (MW 67 000)	70	N.D.
Ribonuclease (MW 13 700)	N.D.	55
Recommended working flow rate range (cm/h)	up to 150	up to 150
Approx. mean particle size (µm)	34	34
Particle size range (µm)	24-44	24-44
working pH range**	2-12	4-13
pH stability***		
short term	1-14	3-14
long term	2-12	4-13

N.D. = Not determined

* The dynamic binding capacity was determined at a linear flow rate of 150 cm/h using a 10.0 mg/ml solution of BSA in 20 mM Tris buffer, pH 8.2 and a 5.0 mg/ml solution of ribonuclease in 100 mM sodium acetate, pH 6.0.

** working pH range refers to the pH range over which the ion exchange groups remain charged and maintain consistently high capacity.

*** pH stability, long term refers to the pH interval where the gel is stable over a long period of time without adverse effects on its subsequent chromatographic performance.

pH stability, short term refers to the pH interval for regeneration and cleaning procedures.

Table 8. Characteristics of HiLoad, HiTrap and BioPilot columns pre-packed with Q and SP Sepharose High Performance.

Product	HiLoad		HiTrap		BioPilot Column	
	16/10	26/10	1 ml	5 ml	35/100	60/100
Column dimensions (mm) (inner diameter x bed height)	16x100	26x100	7x25	16x25	35x100	60x100
Bed volume (ml)	20-22	53-58	1	5	100	300
Maximum flow rate* (ml/min)	5	13	4	20	25 70	
Recommended working flow rate range (ml/min)	up to 5	up to 13	1	5	up to 24 (for SP) up to 16 (for Q)	up to 70 (for SP) up to 47 (for Q)
Max pressure* (MPa)	0.3	0.3	0.3		0.31.1	1.1
Number of theoretical plates per meter** (N/m)	>12 000	>12 000	N.D.	N.D.	>10 000	>10 000

* Max. pressures and flow rates should not be used routinely.

** Determined with acetone.

Flow rate

The rigidity of Sepharose High Performance based ion exchangers together with the small particle size distribution of the 34 μm beads confers excellent flow properties. Flow rates achievable with Sepharose High Performance media and pre-packed columns are given in Table 7 and 8.

Availability

Q and SP Sepharose High Performance are available in packs of 75 ml, 1 and 5 litres.

To ensure optimal performance and reproducibility Sepharose High Performance media are also available in pre-packed HiLoad columns with dimensions 16 and 26 mm in internal diameter and 10 cm in bed height.

Q and SP Sepharose High Performance are also available in pre-packed, ready-to-use 1 ml and 5 ml columns, HiTrap Q and HiTrap SP respectively. They are designed for method scouting, group separations, sample clean-up or sample concentration.

For pilot scale separations, Q Sepharose High Performance is available in pre-packed BioPilot columns of 100 ml (35/100) and 300 ml (60/100). SP Sepharose High Performance pre-packed in BioPilot columns 35/100 and 60/100 are available on request. For ordering information, please refer to Chapter 14.

Sepharose Fast Flow ion exchangers

Sepharose Fast Flow ion exchangers are based on 90 μm agarose beads. A higher degree of cross-linking, compared to Sepharose CL-6B based ion exchangers, is used to give the media greatly improved physical and chemical stability. This high

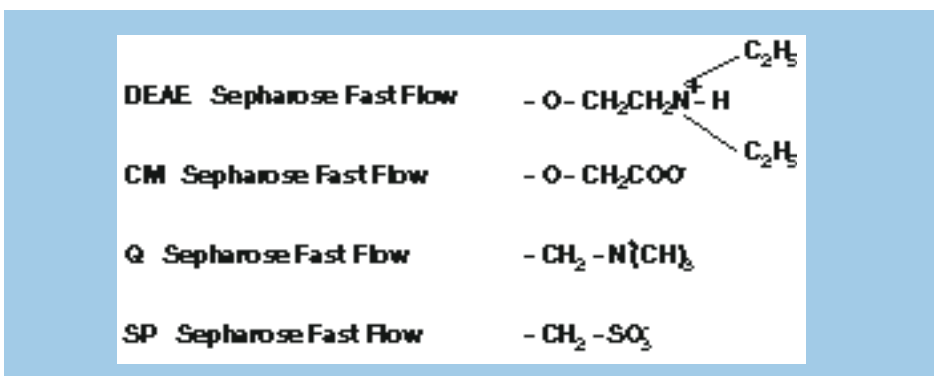

Fig. 25. Partial structure of Sepharose Fast Flow ion exchange media.

stability allows the gels to be used at the higher flow rates required for modern laboratory separations as well as meeting the throughput and cleaning-in-place requirements of process scale chromatography.

To give a complete range of ion exchange media Sepharose Fast Flow is available with the weak exchanger groups, DEAE and CM and the strong exchanger groups Q and SP. Figure 2.5 shows the partial structures of these media. Characteristics of the different ion exchangers based on Sepharose Fast Flow is listed in Table 9.

Table 9. Characteristics of Q, SP, DEAE and CM Sepharose Fast Flow.

Product	Q Sepharose Fast Flow	SP Sepharose Fast Flow	DEAE Sepharose Fast Flow	CM Sepharose Fast Flow
Type of gel	strong anion	strong cation	weak anion	weak cation
Total ionic capacity (µmol/ml gel)	180-250	180-250	110-160	90-130
Recommended working flow rate range (cm/h)	100-300	100-300	100-300	100-300
Approx. mean particle size (µm)	90	90	90	90
Particle size range (µm)	45-165	45-165	45-165	45-165
working pH range*	2-12	4-13	2-9	6-10
pH stability**				
short term	1-14	3-14	1-14	2-14
long term	2-12	4-13	2-13	4-13

* working pH range refers to the pH range over which the ion exchange groups remain charged and maintain consistently high capacity.

** pH stability, long term refers to the pH interval where the gel is stable over a long period of time without adverse effects on its subsequent chromatographic performance.

pH stability, short term refers to the pH interval for regeneration and cleaning procedures.

Properties

Physical stability

Sepharose Fast Flow ion exchangers are supplied pre-swollen and ready for packing or in pre-packed columns. The highly cross-linked nature of the matrix means that the bead size and bed volumes do not change with changes in ionic strength or pH.

Capacity

As is the case with all ion exchangers the capacity is dependent upon the accessibility of the charged groups and their number. Sepharose Fast Flow ion exchangers are highly substituted and have an exclusion limit of approximately 4×10^6 giving

high capacity for proteins. Capacity data for Fast Flow ion exchange media are given in Table 10. Characteristics specific for pre-packed columns with Q and SP Sepharose Fast Flow, HiLoad columns, are shown in Table 11.

Table 10. Capacity data for Sepharose Fast Flow ion exchangers.

Ion Exchanger	Q Sepharose Fast Flow	SP Sepharose Fast Flow	DEAE Sepharose Fast Flow	CM Sepharose Fast Flow
Total ionic capacity (μmol/ml gel)	180-250	180-250	110-160	90-130
Dynamic binding capacity* (mg/ml gel)				
Thyroglobulin (MW 669 000)	3	N.D.	3.1	N.D.
HSA (MW 68 000)	120	N.D.	110	N.D.
α-lactalbumin (MW 14 300)	110	N.D.	100	N.D.
IgG (MW 160 000)	N.D.	50	N.D.	15
Bovine COHb (MW 69 000)	N.D.	50	N.D.	30
Ribonuclease (MW 13 700)	N.D.	70	N.D.	50

N.D. = Not determined

*Capacities were determined using the method described in Chapter 10 at a flow rate of 75 cm/h. For anion exchangers (DEAE and Q) the starting buffer was 0.05 M Tris, pH 8.3 and for cation exchangers (CM and S) 0.1 M acetate buffer, pH 5.0. Limit buffers were the respective start buffers containing 2.0 M NaCl.

Table 11. Characteristics of HiLoad columns pre-packed with Q and SP Sepharose Fast Flow.

Product	HiLoad 16/10	HiLoad 26/10
Bed volume (ml)	20-22	53-58
Maximum flow rate* (ml/min)	10	26
Recommended working flow rate range (ml/min)	up to 7	up to 18
Max pressure* (MPa)	0.3	0.3
Number of theoretical plates per meter** (N/m)	>3000	>3000

* Max. pressures and flow rates should not be used routinely.

** Determined with acetone.

Q Sepharose Fast Flow and SP Sepharose Fast Flow are highly substituted with strong ion exchange groups. These groups remain charged and maintain consistently high capacities over broad working pH ranges of 2-12 and 4-13 respectively. This allows the selection of a pH value and buffer that best suit the properties of the sample. Titration curves for both gels are shown in Figure 26. The working pH ranges for DEAE Sepharose Fast Flow and CM Sepharose Fast Flow are 2-9 and 6-10 respectively.

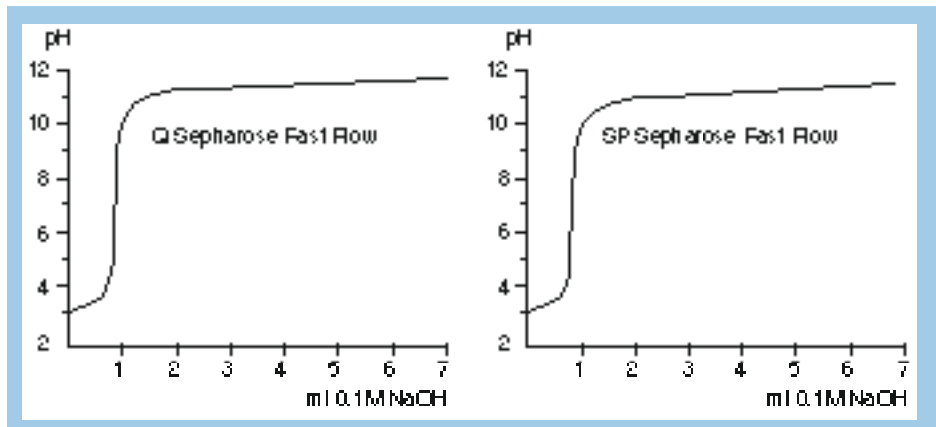

Fig. 26. Titration curves; approximately 5 ml Q and SP Sepharose Fast Flow in 50 ml 1 M KCl. (Work by Pharmacia Biotech, Uppsala, Sweden.)

Flow rate

The optimal cross-linking of Sepharose Fast Flow confers excellent flow properties on the matrix. This is illustrated in Figure 27 which shows the relationship between flow rate and operating pressure for DEAE Sepharose Fast Flow.

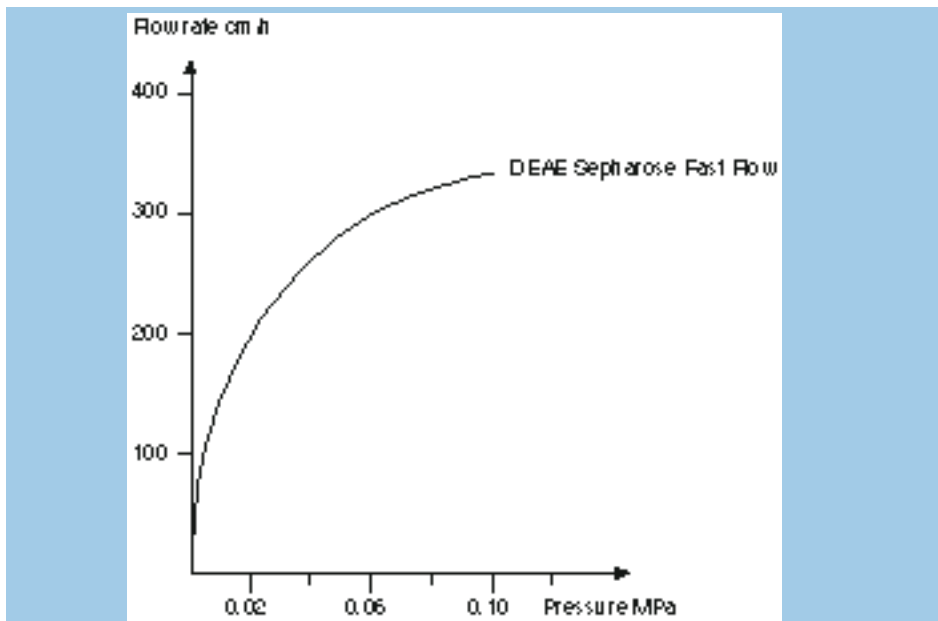

Fig. 27. Flow rate as a function of pressure drop of DEAE Sepharose Fast Flow. Column: Pharmacia XK 50/30 fitted with 1/4 inch tubing. Gel bed height 15 cm. Gel volume 294 ml. Eluent 0.1 M NaCl. (Work by Pharmacia Biotech, Uppsala, Sweden.)

Flow rates achievable with Fast Flow media are above 300 cm/h at 0.1 MPa (1 bar) in an XK 50/30 column packed with a 15 cm high bed of gel. In laboratory separations where the best possible separation is frequently a major consideration this flow rate is frequently traded off against improved resolution. In industrial processing, the high throughput properties of Sepharose Fast Flow ion exchangers give significantly reduced cycle times and improved productivity.

Availability

DEAE and CM Sepharose Fast Flow are available in packs of 500 ml, 10 and 60 litres. Q and SP Sepharose Fast Flow are available in packs of 25 ml, 300 ml, 5 and 60 litres and are also available pre-packed in HiLoad 16/10 and 26/10 columns. Q, DEAE and CM Sepharose Fast Flow are supplied in 20% ethanol and SP Sepharose Fast Flow in 20% ethanol with 0.2 M sodium acetate. For ordering information, please refer to Chapter 14.

Sepharose Big Beads ion exchangers

Sepharose Big Beads ion exchangers are based on 100-300 μm agarose beads. A higher degree of cross-linking, compared to Sepharose CL-6B based ion exchangers, is used to give the media greatly improved physical and chemical stability. Due to its excellent physical stability and large bead size, Sepharose Big Beads can be run at high flow rates even with viscous samples. Table 12, gives the characteristics of Q and SP Sepharose Big Beads.

Table 12. Characteristics of Q and SP Sepharose Big Beads.

Product	Q Sepharose Big Beads	SP Sepharose Big Beads
Type of gel	strong anion	strong cation
Total ionic capacity ($\mu\text{mol/ml}$ gel)	180-250	180-250
Recommended working flow rate range (cm/h)	1200-1800	1200-1800
Approx. mean particle size (μm)	200	200
Particle size range (μm)	100-300	100-300
working pH range*	2-12	4-13
pH stability**		
short term	2-14	3-14
long term	2-12	4-13

* working pH range refers to the pH range over which the ion exchange groups remain charged and maintain consistently high capacity.

** pH stability, long term refers to the pH interval where the gel is stable over a long period of time without adverse effects on its subsequent chromatographic performance.

pH stability, short term refers to the pH interval for regeneration and cleaning procedures.

Properties

Physical stability

Sepharose Big Beads ion exchangers are supplied pre-swollen and ready for packing. The average bead diameter is 200 μm with a bead size distribution of 100-300 μm . The highly cross-linked nature of the matrix means that the bead size and bed volumes do not change with changes in ionic strength or pH.

Capacity

Q and SP Sepharose Big Beads are highly substituted with strong ion exchange groups. These groups remain charged and maintain consistently high capacities over broad working pH ranges of 2-12 and 4-13 respectively. This allows the selection of a pH value and buffer that best suit the properties of the sample. Figure 28 shows typical binding capacities of SP Sepharose Big Beads.

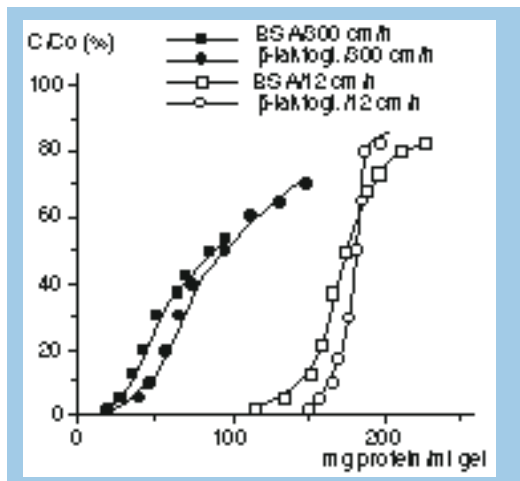

Fig. 28. Typical binding capacities of SP Sepharose Big Beads media. The binding capacity was measured with frontal analysis in acetate pH 5 for bovine serum albumin and format pH 4.1 for β -lactoglobulin at linear flow rates of 12 and 300 cm/h. (Work by Pharmacia Biotech, Uppsala, Sweden.)

Flow rate

Because of its flow characteristics, Q and SP Sepharose Big Beads is the choice for initial purification when high viscosity precludes the use of ion exchangers with smaller bead size, e.g. Sepharose Fast Flow ion exchangers. Even with viscosities as high as 2.5 times water a high flow rate (500 cm/h) is maintained in industrial column operation.

Availability

Q and SP Sepharose Big Beads are available in packs of 1 and 10 litres. For ordering information, please refer to Chapter 14.

STREAMLINE SP and STREAMLINE DEAE

STREAMLINE adsorbents are specifically developed for expanded bed adsorption, see page 98 for details, and are based on a modified Sepharose matrix, cross-linked 6% agarose.

STREAMLINE adsorbents have been designed with a well-defined density distribution, which is required in expanded bed adsorption. This is achieved through inclusion of inert crystalline quartz material in the base matrix. Mean particle density is approximately 1.2 g/ml drained gel. The porosity is comparable to Sepharose Fast Flow ion exchangers, with an exclusion limit of 4×10^6 for globular proteins.

Table 13. Characteristics of STREAMLINE ion exchange adsorbents.

Product	STREAMLINE SP	STREAMLINE DEAE
Type of gel	strong cation	weak anion
Total ionic capacity ($\mu\text{mol/ml gel}$)	170-240	130-210
Dynamic binding capacity* (mg/ml gel)		
Lysozyme (MW 14 500)	70	N.D.
BSA (MW 67 000)	N.D.	55
Recommended working flow rate range (cm/h)		
- sample application	200-400	200-400
- elution	50-150	50-150
Approx. mean particle size (μm)	200	200
Particle size range (μm)	100-300	100-300
working pH range**	4-13	2-9
pH stability***		
short term	3-14	1-14
long term	4-13	2-13

N.D. = Not determined

*The binding capacity was determined in STREAMLINE 50 column at a linear flow rate of 300 cm/h using a 2.0 mg/ml solution of protein in phosphate buffer, pH 7.5 (lysozyme) and 50 mM Tris-HCl buffer, pH 7.5 (BSA).

** working pH range refers to the pH range over which the ion exchange groups remain charged and maintain consistently high capacity.

*** pH stability, long term refers to the pH interval where the gel is stable over a long period of time without adverse effects on its subsequent chromatographic performance.

pH stability, short term refers to the pH interval for regeneration and cleaning procedures.

Properties

Physical stability

STREAMLINE adsorbents are supplied pre-swollen and ready for use. The average bead diameter is 200 μm with a bead size distribution of 100-300 μm . The highly cross-linked nature of the matrix means that the bead size and bed volumes do not change with changes in ionic strength or pH.

Capacity

As is the case with all ion exchangers the binding capacity of STREAMLINE adsorbents are dependent on each different molecule's size and pI, the flow rate etc. In general, the adsorption characteristics of STREAMLINE adsorbents are similar to those of a packed bed in chromatography, a direct result of the stability of the expanded bed during feed application. This is illustrated in Figure 29 which compares the breakthrough curves for a model protein with STREAMLINE DEAE in packed mode and expanded mode at two scales of operation.

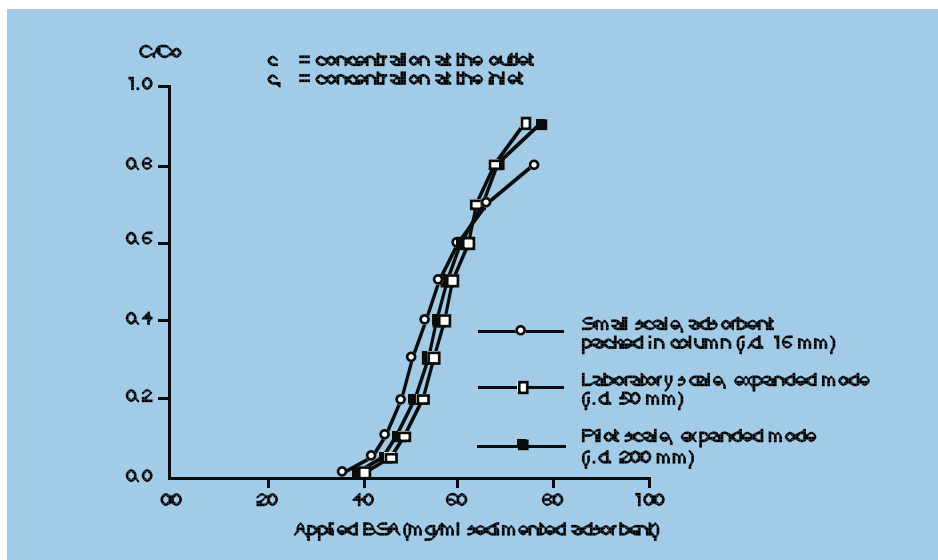

Fig. 29. Breakthrough capacity curve comparisons. Running conditions: BSA in 50 mM Tris-HCl, pH 7.5, linear flow rate 300 cm/h. (Work by Pharmacia Biotech, Uppsala, Sweden.)

STREAMLINE SP and STREAMLINE DEAE are highly substituted with ion exchange groups. These groups remain charged and maintain consistently high capacities over the working pH ranges of 4-13 and 2-9 respectively. This allows the selection of a pH value and buffer that best suit the properties of the sample.

Availability

STREAMLINE SP and DEAE are available in packs of 300 ml and 7.7 litres. For ordering information, please refer to Chapter 14.

DEAE Sepharose CL-6B and CM Sepharose CL-6B

DEAE Sepharose CL-6B and CM Sepharose CL-6B are macroporous bead-formed (mean particle size of 90 μm diameter) ion exchangers derived from the cross-linked agarose gel Sepharose CL-6B. DEAE or CM groups are then attached to the gel by ether linkages to the monosaccharide units to give the final ion exchange gel (Fig. 30).

DEAE Sepharose CL-6B and CM Sepharose CL-6B have good chemical and physical stability and can be used to advantage in the ion exchange chromatography of proteins, polysaccharides, nucleic acids, membrane components and other high molecular weight substances.

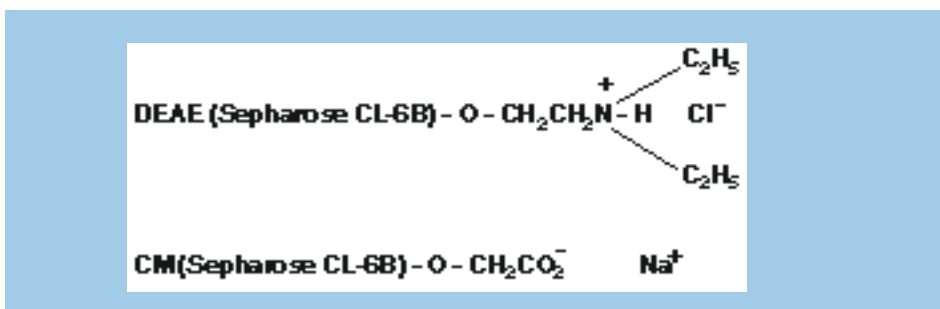

Fig. 30. Partial structure of Sepharose CL-6B ion exchangers.

Properties

Physical stability

DEAE and CM Sepharose CL-6B are supplied pre-swollen and ready for packing. As stated earlier, the cross-linked nature of the matrix means that the bed volume changes very little with changes in ionic strength or pH (approximately 2% change when the pH is reduced from 10 to 4).

Capacity

Since DEAE and CM Sepharose CL-6B are weak ion exchangers, the number of ligand groups which are charged and hence the capacity for macromolecules is dependent upon pH. This dependency is illustrated by the titration curves for DEAE and CM Sepharose CL-6B (Fig. 31).

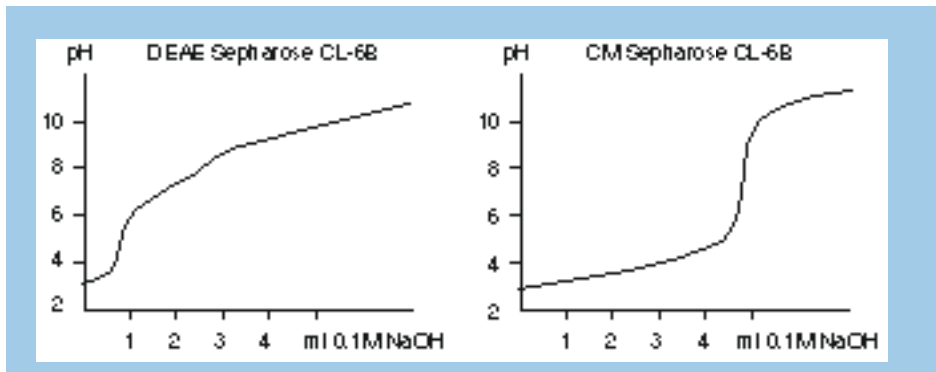

Fig. 31. Titration curves; Approximately 5 ml DEAE and CM Sepharose CL-6B both in 50 ml 1 M KCl. (Work by Pharmacia Biotech, Uppsala, Sweden.)

The working pH ranges for the media are 2-9 for DEAE Sepharose CL-6B and 6-10 for CM Sepharose CL-6B.

DEAE and CM Sepharose CL-6B have exclusion limits of approximately 4×10^6 . Capacity data for Sepharose CL-6B ion exchangers are summarized in Table 14.

Table 14. Characteristics of Sepharose CL-6B ion exchangers.

	DEAE Sepharose CL-6B	CM Sepharose CL-6B
Total ionic capacity (µmol/ml gel)	130-170	100-140
Dynamic binding capacity* (mg/ml gel)		
Thyroglobulin (MW 669 000)	2.0	N.D.
IgG (160 000)	N.D.	9.5
Bovine COHb (MW 69 000)	N.D.	75
HSA (MW 68 000)	170	N.D.
α-lactalbumin (MW 14 300)	150	N.D.
Ribonuclease (MW 13 700)	N.D.	120
Recommended working flow rate range (cm/h)	up to 60	up to 60
Approx. mean particle size (µm)	90	90
Particle size range (µm)	45-165	45-165
working pH range**	2-9	6-10
pH stability***		
short term	2-14	2-14
long term	3-12	4-13

N.D. = Not determined

*Capacities were determined using the method described in Chapter 10 at a flow rate of 75 cm/h. For the anion exchanger (DEAE) the starting buffer was 0.05M Tris, pH 8.3 and for the cation exchangers (CM) 0.1 M acetate buffer, pH 5.0. Limit buffers were the respective start buffers containing 2.0 M NaCl.

** working pH range refers to the pH range over which the ion exchange groups remain charged and maintain consistently high capacity.

*** pH stability, long term refers to the pH interval where the gel is stable over a long period of time without adverse effects on its subsequent chromatographic performance.

pH stability, short term refers to the pH interval for regeneration and cleaning procedures.

Flow rate

The cross-linked structure of Sepharose CL-6B ion exchangers allows flow rates of up to 100 cm/h to be used. Figure 32 illustrates the variation of flow rate with pressure drop for DEAE and CM Sepharose CL-6B.

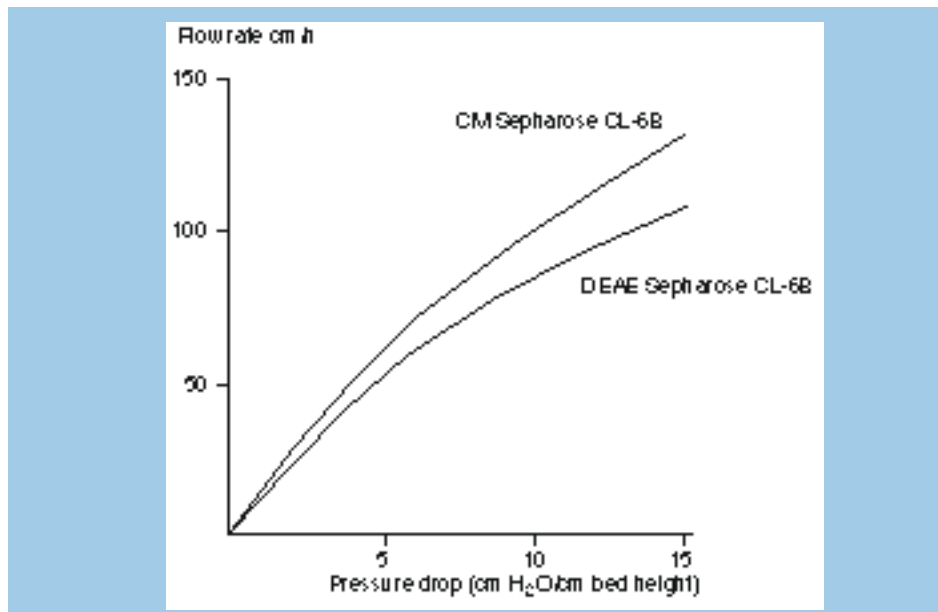

Fig. 32. Flow rate as a function of pressure drop in columns (5x10 cm bed volume) of DEAE and CM Sepharose CL-6B. pH 7.0; Ionic strength 0.02. (Work by Pharmacia Biotech, Uppsala, Sweden.)

As in all types of chromatography, resolution is dependent on flow rate (5). Therefore in applications where resolution is critically important high flow rates should be avoided or an exchanger based on Sepharose High Performance used.

For applications where high flow rates and large throughput of material are required, ion exchangers based on Sepharose Fast Flow or Sepharose Big Beads should be used since these forms have been specially developed with these criteria in mind.

Availability

DEAE and CM-Sepharose CL-6B are available in packs of 500 ml and 10 litres. The gels are supplied in 20% ethanol. For ordering information, please refer to Chapter 14.

7. DEAE Sephacel

DEAE Sephacel is a bead-formed cellulose ion exchanger produced from high purity microcrystalline cellulose. Cellulose is a naturally occurring polymer consisting of $\beta(1-4)$ linked glucose units. In the native state, adjacent polysaccharide chains are extensively hydrogen bonded, forming microcrystalline regions. These regions are interspersed with amorphous regions with less hydrogen bonding. Limited acid hydrolysis results in preferential loss of the amorphous regions and gives so-called microcrystalline cellulose.

During the production of DEAE Sephacel the microcrystalline structure is broken down and the cellulose is regenerated to give a bead-formed (40-160 μm) gel. The gel is strengthened by cross-linking with epichlorohydrin, although the main structure-forming bonds are still hydrogen bonds. Functional groups are attached during the synthesis by ether linkages to glucose units of the polysaccharide chains to give the structure shown in Figure 33.

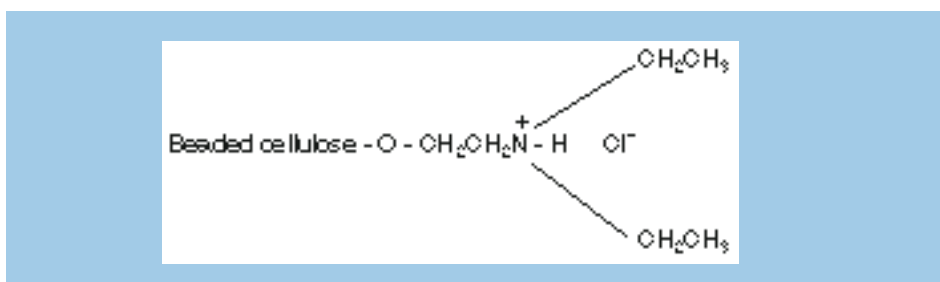

Fig. 33. Partial structure of DEAE Sephacel.

Properties

Chemical stability

DEAE Sephacel is stable in aqueous suspension within the range pH 2-12. Hydrolysis may occur in strongly acidic solutions and the macromolecular structure is broken down in strongly alkaline solutions. The free base form of the DEAE group is inherently unstable at high pH values. Strong oxidizing agents should be avoided.

DEAE Sephacel is susceptible to microbial attack, especially in the presence of phosphates, and should therefore be stored in the presence of antimicrobial agents when not in use (see page 103). Samples containing enzymes capable of hydrolysing β -glucosidic linkages should be purified on MonoBeads, MiniBeads, SOURCE, Sepharose or Sephadex based ion exchangers.

Physical stability

The cross-linked bead form of DEAE Sephacel gives it increased physical stability compared to ordinary microgranular celluloses. It has a stable bed volume over a wide range of ionic strengths (approx. 5% change between $I = 0.05$ and $I = 0.5$) and pH values and can therefore be re-equilibrated in the column.

DEAE Sephacel can be sterilized by autoclaving at pH 7 for 30 minutes at 121 °C. During autoclaving, minute quantities of carbohydrate are released; these can be washed away with sterile buffer solution.

Capacity

DEAE Sephacel is macroporous and has an exclusion limit for proteins with molecular weights of approximately 1×10^6 . The binding of substances with molecular weights substantially greater than 1×10^6 will be restricted to charged groups on the surface of the beads. Capacity data for DEAE Sephacel is summarized in Table 15.

Table 15. Capacity data for DEAE Sephacel.

	Total ionic capacity		Dynamic binding capacity* (mg/ml gel)	
	($\mu\text{mol}/\text{mg gel}$)	($\mu\text{mol}/\text{ml gel}$)	albumin	thyroglobulin
DEAE Sephacel	130-150	100-140	160	10

*Capacity was determined using the method described in Chapter 10 at a flow rate of 75 cm/h. The starting buffer was 0.05 M Tris, pH 8.3 Limit buffer was start buffer containing 2.0 M NaCl.

The adsorption kinetics for bead-formed cellulose ion exchangers are substantially the same as for conventional cellulose ion exchangers (11). As with other weak ion exchangers the capacity varies with pH. The titration curve for DEAE Sephacel is shown in Figure 34.

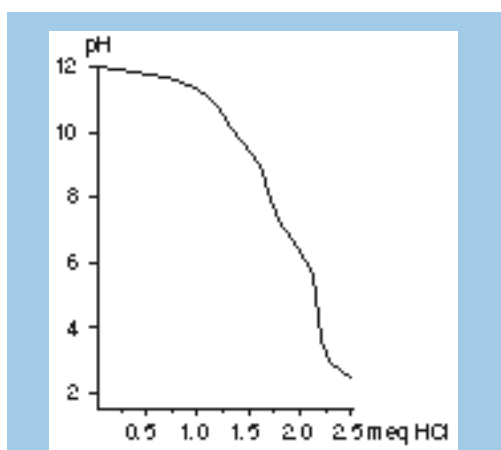

Fig. 34. Titration of 1 g DEAE Sephacel in 1 M KCl. (Work by Pharmacia Biotech, Uppsala, Sweden.)

Flow rate

As with other ion exchangers, resolution decreases with increasing flow rate. Flow rates of 10 cm/h are usually suitable for the resolution of protein mixtures on DEAE Sephacel. Figure 35 illustrates the variation of flow rate as a function of pressure drop for DEAE Sephacel. For applications requiring higher flow rates SOURCE or Sepharose based ion exchangers should be used.

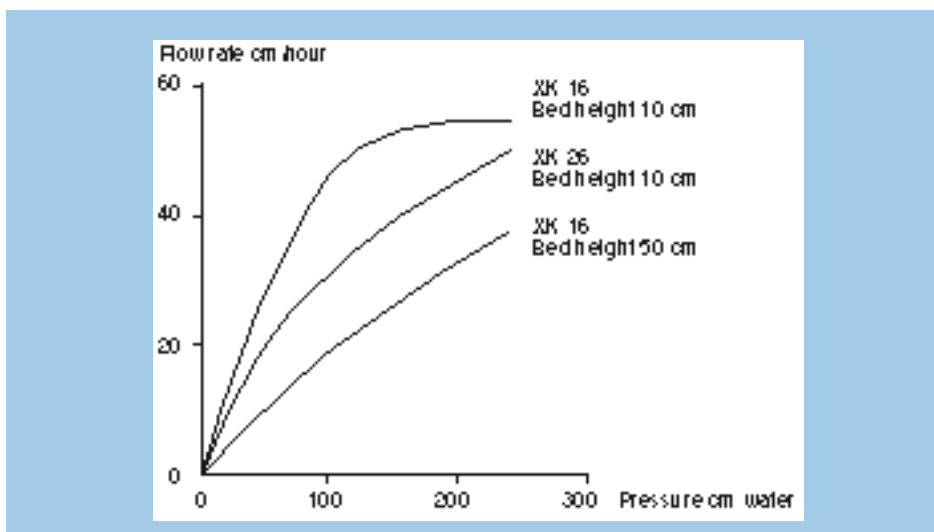

Fig. 35. Flow rate as a function of the pressure drop across beds of DEAE Sephacel. 0.1 M Tris-HCl buffer solution pH 7.6. (Work by Pharmacia Biotech, Uppsala, Sweden.)

Availability

DEAE Sephacel is supplied in packs of 500 ml as a suspension in 20% ethanol. For ordering information, please refer to Chapter 14.

8. Sephadex ion exchangers

Sephadex ion exchangers are produced by introducing functional groups onto Sephadex, a cross-linked dextran matrix. These groups are attached to glucose units in the matrix by stable ether linkages.

Sephadex is suitable as a base for an ion exchanger matrix since it is hydrophilic and shows very low non-specific adsorption.

Sephadex ion exchangers are derived from either Sephadex G-25 or Sephadex G-50 and swell readily in aqueous solutions. Ion exchangers based on Sephadex G-25 are more tightly cross-linked than those based on Sephadex G-50 and therefore swell less and have greater rigidity. Ion exchangers based on Sephadex G-50 are more porous than those based on Sephadex G-25 and therefore have a better capacity for molecules with molecular weights larger than 30 000.

The full range of Sephadex ion exchangers is shown in Table 16. Anion and cation exchangers are designated as A-25 or A-50 and C-25 or C-50, respectively, depending on the matrix porosity.

Table 16. Sephadex ion exchangers.

Types		Description	Functional groups	Counter ion
DEAE Sephadex	A-25 A-50	Weakly basic anion exchanger	Diethylaminoethyl	Chloride
QAE Sephadex	A-25 A-50	Strongly basic anion exchanger	Diethyl-(2-hydroxy- propyl)aminoethyl	Chloride
CM Sephadex	C-25 C-50	Weakly acidic cation exchanger	Carboxymethyl	Sodium
SP Sephadex	C-25 C-50	Strongly acidic cation exchanger	Sulphopropyl	Sodium

Properties

Chemical stability

Sephadex ion exchangers are insoluble in all solvents. They are stable in water, salt solutions, organic solvents, alkaline and weakly acidic solutions. In strongly acidic solutions, hydrolysis of the glycosidic linkages may occur and thus pH values below 2 should be avoided, particularly at elevated temperatures. Sephadex ion exchangers can also be used in the presence of denaturing solvents which can be important when substances are to be separated on the basis of their electrostatic properties alone (12, 13, 14).

Exposure to strong oxidizing agents or dextranases should be avoided. During regeneration, the ion exchanger can be exposed to 0.2 M NaOH for a short time

without appreciable hydrolysis. Sephadex ion exchangers are susceptible to attack by dextranases and should be stored in the presence of an antimicrobial agent (see page 103).

Physical stability

Swollen Sephadex ion exchangers can be sterilized by autoclaving for up to 30 min at 121 °C, at neutral pH in the salt form. During autoclaving, minute quantities of carbohydrate are released; these can be washed away with sterile buffer.

Swelling

The swelling properties of Sephadex ion exchangers are related to those of the parent Sephadex G-types, those based on 50-types swelling more than those based on 25-types. Due to the presence of charged groups in the matrix, the swelling varies with ionic strength and pH.

Ionic strength dependence

At low ionic strengths, repulsion between groups carrying the same charge on the matrix is maximal, and swelling of the gel is at its greatest. The degree of swelling decreases with increasing ionic strength.

Note: Sephadex ion exchangers should not be swollen in distilled water since the bead structure may be broken down due to strong ionic interactions.

pH dependence

The degree of dissociation and hence the extent to which an ion exchanger is charged is dependent on pH. Repulsion between charged groups is greatest at pH values where the ion exchanger is fully dissociated, and decreases at pH values close to the pK of the charged groups.

Note: QAE Sephadex and SP Sephadex have swelling properties quite independent of pH since they are charged over a very wide pH range.

Capacity

Due to differences in swelling characteristics, ion exchangers based on Sephadex G-25 have a much higher ionic capacity per ml gel than those based on Sephadex G-50. (Table 17).

Table 17. Total ionic capacity data for Sephadex based ion exchangers.

Ion exchanger		Total ionic capacity	
		($\mu\text{mol}/\text{mg}$ dry gel)	($\mu\text{mol}/\text{ml}$ wet gel)
DEAE	A-25	3.5 ± 0.5	500
Sephadex	A-50		175
QAE	A-25	3.0 ± 0.4	500
Sephadex	A-50		100
CM	C-25	4.5 ± 0.5	550
Sephadex	C-50		170
SP	C-25	2.3 ± 0.3	300
Sephadex	C-50		90

Thus for smaller biomolecules ($\text{MW} < 30\,000$) the A-25 and C-25 types have a higher available capacity. In the molecular weight range 30 000 to 100 000 however, the A-50 and C-50 exchangers have higher available capacities due to their larger pore size.

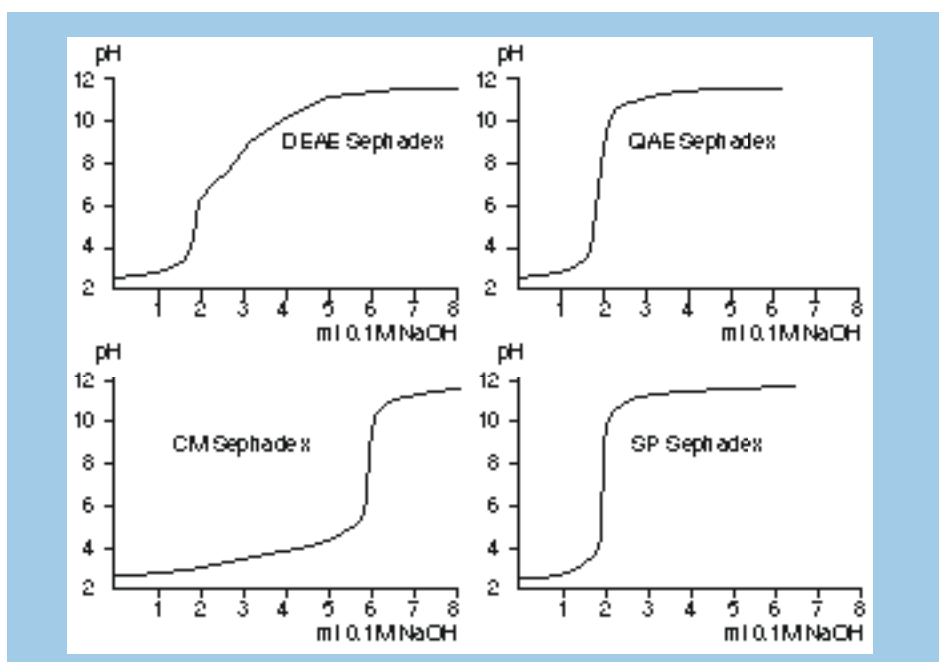

Fig. 36. Titration of 0.1 gram of Sephadex ion exchangers in 50 ml 1 M KCl. (Work by Pharmacia Biotech, Uppsala, Sweden.)

If working with larger molecules (MW > 100 000), a higher available capacity is frequently observed with the A-25 and C-25 types since at these molecular weights binding is only occurring on the bead surface and the higher ionic capacity can be used to advantage.

As capacity also depends upon the number of substituent groups which are charged under given buffer conditions, it will also vary with pH. The variation of the charge on Sephadex ion exchangers with pH is illustrated by their titration curves (Fig. 36).

Dynamic capacity data for Sephadex ion exchangers are given in Table 18.

Table 18. Dynamic capacity (mg/ml wet gel) data for Sephadex ion exchangers

Protein (MW)		Thyroglobulin (669 000)	HSA (68 000)	α-lactalbumin (14 300)	IgG (160 000)	Bovine COHb (69 000)
Ion exchanger						
DEAE	A-25	1.0	30.0	140.0	N.D.	N.D.
Sephadex	A-50	2.0	110.0	50.0	N.D.	N.D.
QAE	A-25	1.5	10.0	110.0	N.D.	N.D.
Sephadex	A-50	1.2	80.0	30.0	N.D.	N.D.
CM	C-25	N.D.	N.D.	N.D.	1.6	70.0
Sephadex	C-50	N.D.	N.D.	N.D.	7.0	140.0
SP	C-25	N.D.	N.D.	N.D.	1.1	70.
Sephadex	C-50	N.D.	N.D.	N.D.	8.0	110.0

N.D. = Not determined

Capacities were determined using the method described in Chapter 10 at a flow rate of 75 cm/h. For anion exchangers (DEAE and QAE) the starting buffer was 0.05M Tris, pH 8.3 and for cation exchangers (CM and SP) 0.1 M acetate buffer, pH 5.0. Limit buffers were the respective start buffers containing 2.0 M NaCl.

Availability

Sephadex ion exchangers are supplied as dry powders in packs of 100 g and 500 g. Bulk quantities of 5 kg or more are available on request. For ordering information, please refer to Chapter 14.

9. Experimental design

Choice of ion exchanger

No single ion exchanger is best for every separation. The choice of matrix and ionic substituent depends on:

1. The specific requirements of the application
2. The molecular size of the sample components
3. The isoelectric points of the sample components

Specific requirements of the application

Column separation, batch separation or expanded bed adsorption

If the separation is to be carried out using a batch separation technique rather than column chromatography, the flow and packing characteristics of the matrix are of minor importance. The economy and high capacity of Sephadex based ion exchangers make them a natural choice.

In large scale applications, capturing proteins from crude samples containing particulate matter, expanded bed adsorption using STREAMLINE has proven to be effective and cost efficient.

The scale of the separation

The amount of sample to be processed is an important parameter when choosing an ion exchange medium. For laboratory scale separations, any of the Pharmacia Biotech range of ion exchangers can be used. However for large scale separations, which must satisfy the throughput and cleaning-in-place (CIP) requirements of industry, the choice of a BioProcess Media such as SOURCE, Sepharose High Performance, Sepharose Fast Flow, Sepharose Big Beads or STREAMLINE adsorbent is indicated.

The same reasoning applies to experiments designed as method scouting for eventual scale-up since such procedures should be developed using the gel which will eventually be used at the larger scale. SOURCE media and Sepharose Fast Flow based exchangers are extremely well suited to this type of method optimization as well as routine laboratory separations.

The required resolution

When choosing an ion exchanger it is important to decide the degree of resolution required from the separation. Normally analytical or semi-analytical separations

place high demands on resolution. In contrast, resolution is frequently traded off against capacity and speed in the case of preparative work.

Resolution in ion exchange chromatography depends upon the selectivity and efficiency of the media. Maximum selectivity is often obtained by choosing one of the gels carrying the strong exchanger groups Q or S/SP, since strong ion exchangers can be used at any pH tolerated by the sample molecules.

Maximum efficiency is obtained by choosing a gel based on a small particle size matrix. The media in order of their particle sizes and potential efficiencies are MiniBeads (3 μm) > MonoBeads (10 μm) > SOURCE 15 (15 μm) > SOURCE 30 (30 μm) > Sepharose High Performance (34 μm) > Sepharose Fast Flow/ Sepharose CL-6B/ Sephacel (90 μm) > Sephadex (40-125 μm in dry form) > STREAMLINE adsorbents/Sepharose Big Beads (200 μm).

The media thus offering the highest degree of resolution are MiniBeads, MonoBeads and SOURCE 15 exchangers for high resolution in SMART, FPLC and HPLC systems and SOURCE 30 and Sepharose High Performance exchangers for high resolution standard chromatography.

The required throughput

How much material which can be processed in a defined time is determined amongst other things by the capacity, the flow characteristics of the media and the size of the column. All of the ion exchangers available from Pharmacia Biotech have high capacities for macromolecules but differ considerably in their flow properties. The media which have optimal flow characteristics are MiniBeads for micropreparative chromatography in SMART System, MonoBeads and SOURCE 15 for high performance, FPLC separations, and SOURCE 30, Sepharose High Performance, Sepharose Fast Flow and Sepharose Big Beads media for laboratory and process scale preparative separations.

The uniform size distribution of beads in SOURCE media provides comparatively low pressure drops over packed beds and thus makes SOURCE ion exchangers also ideal for scaling up in industrial applications such as the separation of closely related product variants.

Scaleability

Frequently ion exchange separations are carried out initially on a small scale to optimize conditions before committing the sample to full scale separations. It is thus important to choose an ion exchanger which will allow simple and convenient scale up so that methods established on a small column can be applied more or less directly to the larger column. Detailed information on scaling up ion exchange separations is given in Chapter 11.

Reproducibility

Reproducibility is obtained when the characteristics of the chromatography bed remain unchanged during the course of the separation and during regeneration of the column. The more rigid varieties of Pharmacia Biotech ion exchangers, such as MiniBeads, MonoBeads, SOURCE, Sepharose High Performance, Sepharose Fast Flow and Sepharose Big Beads, show no changes in bed size with changes in pH and ionic strength and can thus be washed and regenerated in the columns providing additional reproducibility.

The use of media which are supplied pre-packed and tested, such as MiniBeads, MonoBeads, RESOURCE, HiTrap columns pre-packed with Sepharose High Performance and HiLoad columns pre-packed with Sepharose High Performance or Sepharose Fast Flow assures reproducibility since variability in column packing is eliminated.

Economy

Column or batch procedures in which the ion exchanger is used once and thrown away, as well as applications requiring large amounts of gel, may make economy a major consideration. Sephadex A-50 and C-50 ion exchangers are the least expensive in terms of bed volume, followed by Sephadex A-25 and C-25 ion exchangers. Using expanded bed adsorption, STREAMLINE product line, reduces the number of operations in a process by fusing the function clarification, concentration and adsorption into one operation. It offers process developers the selectivity afforded by chromatography, the throughput of ultra-filtration and the convenience of small scale centrifugation.

The molecular size of the sample components

The accessibility of the sample components to the charged groups will determine the available capacity of the ion exchanger for those particular substances. All of the ion exchange media supplied by Pharmacia Biotech, with the exception of Sephadex based media, have exclusion limits for globular proteins in excess of 1×10^6 .

Steric factors only affect the separation of charged solutes via their influence on the available capacity for each substance. When choosing ion exchangers it is unnecessary to consider the possibility of gel filtration effects on the sample. Sample molecules, although always larger than those of the eluent buffer, cannot migrate ahead of the eluting buffer since they then encounter conditions which favour their re-binding to the matrix. Only uncharged solutes will be fractionated according to size as in gel filtration. These uncharged molecules will normally be removed during the initial isocratic elution phase which proceeds the application of the gradient.

The exclusion limits for the different media and subsequent effects on available capacity are given in the relevant sections covering each gel type.

When working with samples of unknown molecular weight the use of MonoBeads, SOURCE and Sepharose based ion exchangers is recommended since they are particularly easy to handle and have good capacities over a large molecular weight range.

Choice of exchanger group

Substances are bound to ion exchangers when they carry a net charge opposite to that of the ion exchanger. This binding is electrostatic and reversible.

In the case of substances which carry only one type of charged group the choice of ion exchanger is clear-cut. Substances which carry both positively and negatively charged groups, however, are termed amphoteric and the net charge which they carry depends on pH (Fig. 37). Consequently at a certain pH value an amphoteric substance will have zero net charge. This value is termed the isoelectric point (pI) and at this point substances will bind to neither anion or cation exchangers. The pH ranges in which the protein is bound to anion or cation exchangers and an arbitrary range of stability are shown in Figure 37.

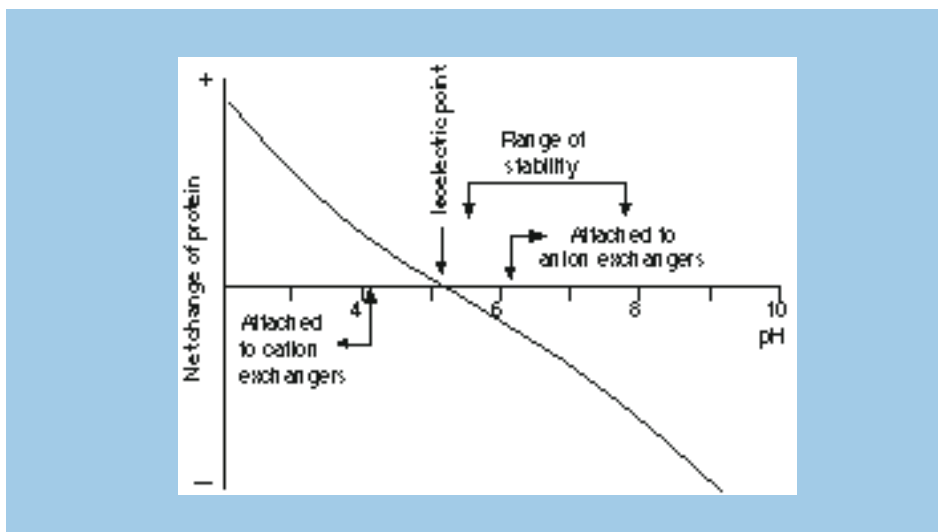

Fig. 37. The net charge of protein as a function of pH.

The pH of the buffer thus determines the charge on amphoteric molecules during the experiment. In principle therefore, one could use either an anion or a cation exchanger to bind amphoteric samples by selecting the appropriate pH. In practice however, the choice is based on which exchanger type and pH give the best separation of the molecules of interest, within the constraints of their pH stability.

Methods for determining the optimum pH and corresponding ion exchanger type are discussed later in this chapter.

Many biological macromolecules become denatured or lose activity outside a certain pH range and thus the choice of ion exchanger may be limited by the stability of the sample. This is illustrated in Figure 37. Below its isoelectric point a protein has a net positive charge and can therefore adsorb to cation exchangers. Above its pI the protein has a net negative charge and can be adsorbed to anion exchangers. However, it is only stable in the range pH 5-8 and so an anion exchanger has to be used.

In summary:

1. If the sample components are most stable below their pI's, a cation exchanger should be used.
2. If they are most stable above their pI's, an anion exchanger should be used.
3. If stability is high over a wide pH range on both sides of pI, either type of ion exchanger can be used.

Determination of starting conditions

The isoelectric point

The starting buffer pH is chosen so that substances to be bound to the exchanger are charged. The starting pH should be at least 1 pH unit above the isoelectric point for anion exchangers or at least 1 pH unit below the isoelectric point for cation exchangers to facilitate adequate binding. Substances begin to dissociate from ion exchangers about 0.5 pH units from their isoelectric points at ionic strength 0.1 M (15).

There are comprehensive lists of isoelectric points determined for proteins (16, 17) which can be useful in the design of ion exchange experiments.

If the isoelectric point of the sample is unknown, a simple test can be performed to determine which starting pH can be used.

Test-tube method for selecting starting pH

1. Set up a series of 10 test-tubes (15 ml).
2. Add 0.1 g Sephadex ion exchanger or 1.5 ml Sepharose or Sephacel ion exchanger to each tube.
3. Equilibrate the gel in each tube to a different pH by washing 10 times with 10 ml of 0.5 M buffer (see page 78 for choice of buffers for ion exchange). Use a range of pH 5-9 for anion and pH 4-8 for cation exchangers, with 0.5 pH unit intervals between tubes.

4. Equilibrate the gel in each tube at a lower ionic strength (0.05 M for Sephadex or 0.01 M for Sepharose and Sephacel ion exchangers) by washing 5 times with 10 ml of buffer of the same pH but lower ionic strength.
5. Add a known constant amount of sample to each tube.
6. Mix the contents of the tubes for 5-10 minutes.
7. Allow the gel to settle.
8. Assay the supernatant for the substance of interest. The results may appear as shown in Figure 38 (a).

The pH to be used in the experiment should allow the substance to be bound, but should be as close to the point of release as possible. If too low (or high) a pH is chosen, elution may become more difficult and high salt concentrations may have to be used. In Figure 38 the buffer chosen should be pH 7.0.

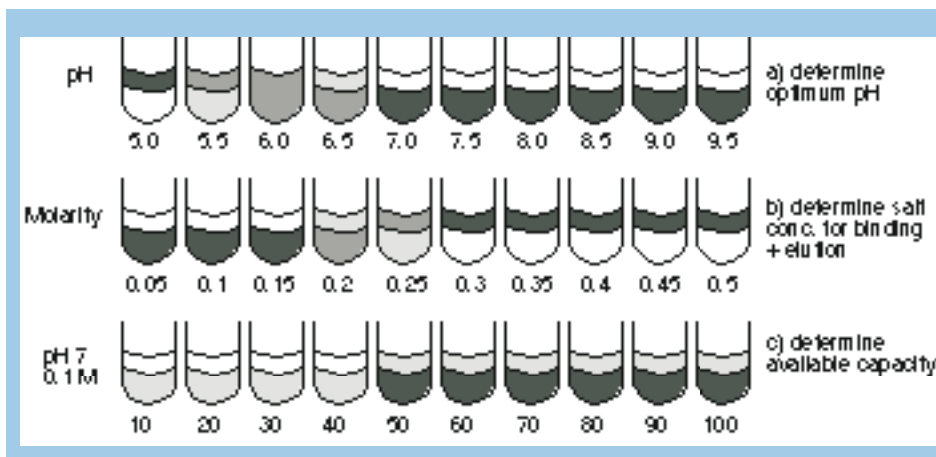

Fig. 38. Test-tube methods for selecting ion exchange conditions.

Electrophoretic titration curves (ETC)

While information on the pI of the sample components gives valuable indications concerning the choice of starting conditions, it does not give a picture of how the charge on the molecules varies with pH (Fig. 37), nor indicate at what pH or on which exchanger type maximum resolution could be expected.

Electrophoretic titration curves (Fig. 39) enable the determination of the charge-pH relationship for the molecules present across a continuum of pH and are a particularly useful way of predicting suitable conditions for an ion exchange separation (18).

An electrophoretic titration curve is obtained by electrophoresis of the sample at right angles to a pH gradient in a horizontal slab gel of agarose or polyacrylamide (19, 20). The pH gradient is established in the gel by isoelectric focusing prior to

sample application. A schematic description of the various steps is shown in Fig. 40. A detailed description of the method using PhastSystem electrophoresis systems is available upon request from Pharmacia Biotech.

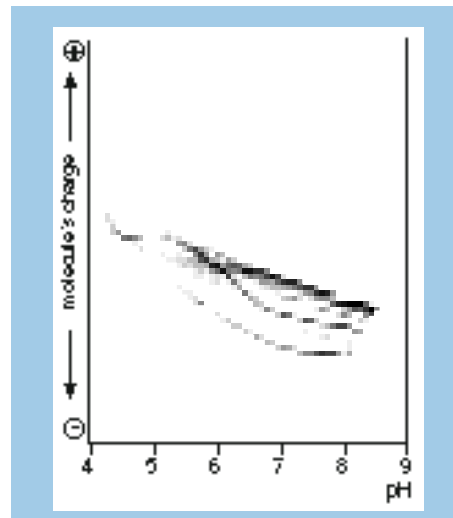

Fig. 39. The electrophoretic titration curve of chicken breast muscle. (19)

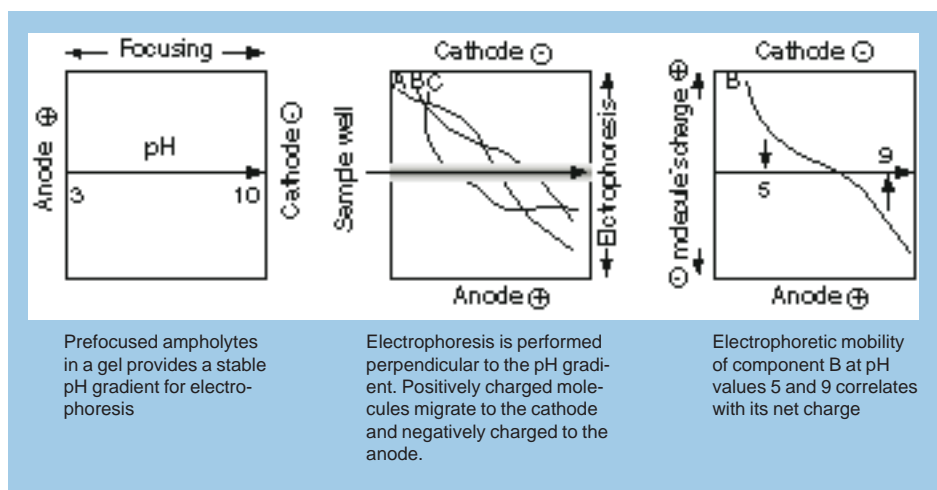

Fig. 40. The major steps in making electrophoretic titration curves.

Electrophoresis of the sample perpendicular to the pH gradient produces a series of curves, unique for each component, since the relative electrophoretic mobility of each component will be different depending on its net charge at given pH values. The pH value where each curve intersects the line of sample application represents the pH at which that particular component has a zero net charge, the pI for that component.

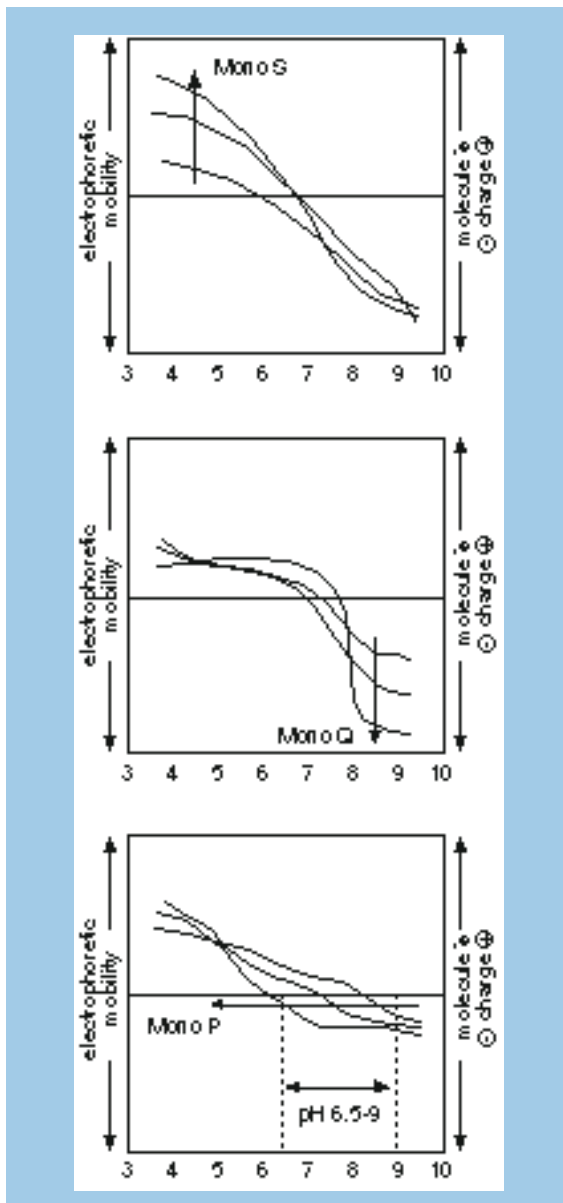

Fig. 41. Column selection based on electrophoretic titration curve analysis.

Maximum resolution can be expected at a pH where there is maximum separation between the titration curves for individual solutes, using the ion exchanger type indicated by the charge of the molecules at that particular pH. At this pH the difference in electrophoretic mobilities and hence net charges between the species is greatest. This principle is illustrated in Figure 41. The protein's stability at the indicated pH must be taken into consideration before applying these conditions to the separation.

If maximum separation is observed at a pH where the sample molecules are positively charged, i.e. below their isoelectric points, maximum resolution will be obtained using a cation exchanger such as Mono S, SOURCE S or SP Sepharose Fast Flow.

If the largest difference in electrophoretic mobility is found at a pH where the components of interest are negatively charged, i.e. above their isoelectric points, an anion exchanger such as Mono Q, SOURCE Q or Q Sepharose Fast Flow should be chosen.

If maximum separation of the curves occurs at the position of sample application i.e. at the isoelectric points of the molecules, then maximum resolution may be achieved using the technique of chromatofocusing. Further information on techniques and media for chromatofocusing is available on request.

Measurement of pH can be done using a surface electrode or by running pI calibration proteins as a narrow band at the top or bottom of the slab gel during the first dimension electrophoresis as the pH gradient is established in the gel. This section of the gel is removed and stained before the sample is applied for the second dimension electrophoresis and then afterwards replaced to estimate pH values.

Staining the titration curve with a general protein stain such as Coomassie Blue does not give any information about the charge/pH relationship for specific proteins unless they can be clearly identified by their isoelectric points. To gain positive identification it is necessary to use a specific detection technique such as zymographic analysis or immunofixation as illustrated in Figure 42.

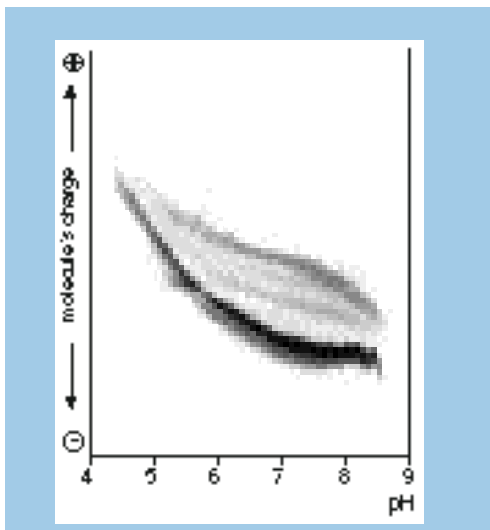

In addition to information regarding optimal starting conditions, the electrophoretic titration curves also reveal important information which will assist the interpretation of the chromatogram after the run.

Fig. 42. The electrophoretic titration curve of chicken breast muscle using zymogram detection for creatine kinase. (19)

Since the lines on the ETC reflect the degree of charge of the components at different pH's, the curves may be used to predict the order in which the components will be eluted from the column. The molecular species with the lowest electrophoretic mobility at a certain pH has logically the lowest charge at that particular pH and should be the first substance eluted from the column in the gradient. Similarly the species showing highest electrophoretic mobility will be the most strongly retained on a column of opposite charge and should be eluted last. The order in which solutes are eluted cannot be predicted with 100% certainty from the titration curve since electrophoretic mobility depends on the total net charge on a molecule and ion exchange chromatography depends on the net charge on the solutes surface.

Chromatographic titration curves (retention maps)

For those ion exchanger types which allow rapid separations, optimal starting pH and choice of anion or cation exchanger can be determined using chromatographic titration curves (18).

In a specified salt gradient, the retention of particular molecular species is dependent upon the molecules net charge and charge density. These in turn depend upon the pH of the eluent. The chromatographic titration curve is based on this relationship between retention and buffer pH.

The methodology is extremely simple. The sample is analysed in a series of rapid separations, carried out on a cation exchanger (Mono S) or an anion exchanger (Mono Q), using the same salt gradient but over a range of pH's.

A plot is then made, for each separated peak, of elution salt concentration, elution time or elution volume against pH. This will produce a series of curves as illustrated in Fig. 43.

An analysis of this composite plot for the point of maximum separation will indicate at what pH and on which type of exchanger maximum resolution between any two or more components can be expected.

The conditions used (column type, buffers, pH, etc.) during the rapid runs for the generation of the chromatographic titration curves can be directly applied when developing the final optimized procedure.

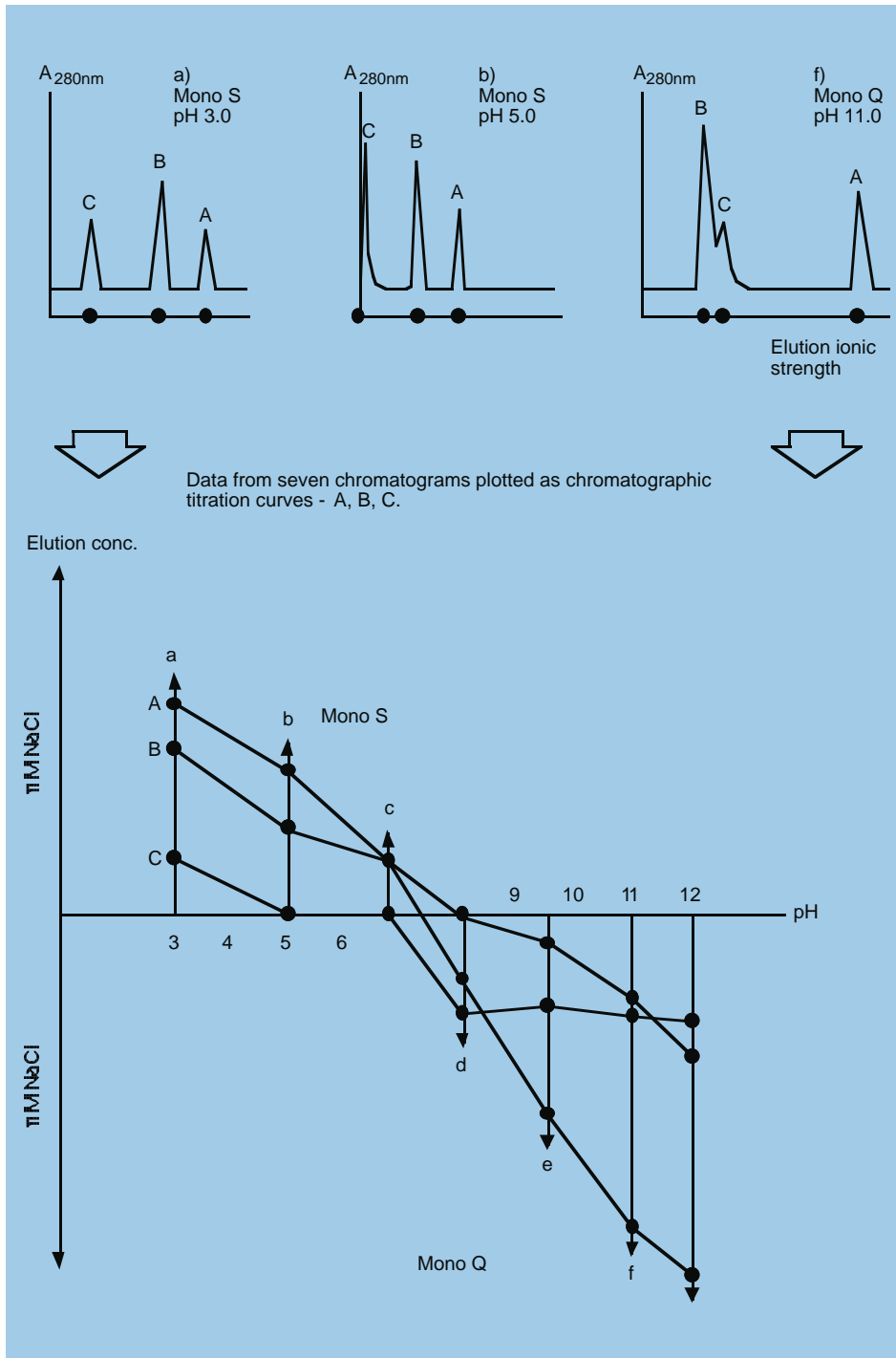

Fig. 43. Chromatographic titration curves.

Choice between strong and weak ion exchangers

Having selected a suitable starting pH to use on a cation or anion exchanger, it is necessary to choose between a strong and weak ion exchange group. In those cases where maximum resolution occurs at an extreme of pH and the molecules of interest are stable at that pH, the choice is clearly to use a strong exchanger. The majority of proteins however, have isoelectric points which lie within the range 5.5 to 7.5 and can thus be separated on both strong and weak ion exchangers. Some advantages in using a strong ion exchanger are discussed in Chapter 2.

Choice of buffer

As with the choice of ion exchanger, there are a number of variables which have to be considered. These include:

1. The choice of buffer pH and ionic strength.
2. The choice of buffering substance.
3. The price of the buffer if it is to be used in production process.

Choice of buffer pH and ionic strength

The choice of buffer pH has been discussed in the previous section. It should be pointed out, however, that in many applications the optimum separation may be achieved by choosing conditions so that major and troublesome contaminants are bound to the exchanger while the substance of interest is eluted during the wash phase (21). This procedure is sometimes referred to as “starting state elution”.

Note: Concentration of sample does not occur with starting state elution.

The highest ionic strength which permits binding of the selected substances and the lowest ionic strength that causes their elution should normally be used as the starting and final ionic strengths in subsequent column experiments (i.e. the starting and limiting buffers for gradient elution). A third and higher ionic strength buffer is frequently employed as a wash step before column regeneration and re-use.

The required concentration of the start buffer will vary depending on the nature of the buffering substance. A list of some suitable buffers and suggested start concentrations is shown in Table 19. In the majority of cases a starting ionic strength of at least 10 mM is required to ensure adequate buffering capacity.

Salts also play a role in stabilizing protein structures in solution and so it is important that the ionic strength should not be so low that protein denaturation or precipitation occurs. A major advantage of using Pharmacia Biotech ion exchangers is that they have excellent capacities and so the initial ionic strength of the buffer can be quite high without significantly affecting capacity for sample.

In the case of pre-packed ion exchangers and columns which can be run conveniently quickly, trial experiments using salt gradients will allow the determination of an optimal starting ionic strength.

In the case of Sephadex based exchangers for batch applications or where column running times are prohibitively long, a simple test-tube technique is recommended as a test for a suitable ionic strength.

Choice of buffer substance

If the buffering ions carry a charge opposite to that of the functional groups of the ion exchanger they will take part in the ion exchange process and cause local disturbances in pH. It is preferable, therefore, to use buffering ions with the same charge sign as the substituent groups on the ion exchanger. There are of course exceptions to this rule as illustrated by the frequency with which phosphate buffers are cited in the literature in connection with anion exchangers. In those instances when a buffering ion which interacts with the ionic groups on the matrix is used, extra care must be taken to ensure that the system has come to equilibrium before application of sample.

In cases where substances purified by ion exchange chromatography have to be freeze dried it is advantageous to use volatile buffer systems. Examples of such systems are shown in Table 20.

Table 19. Buffer tables.

Buffer substances for cation exchange chromatography

pKa (25°C)	pH interval	Substance	Conc. (mM)dT	dpKa/ (°C)	Counter-ion	Comments
2.00	1.5-2.5	Maleic acid	20		Na ⁺	Dicarboxylic acid
2.88	2.38-3.38	Malonic acid	20		Na ⁺ /Li ⁺	Dicarboxylic acid
3.13	2.63-3.63	Citric acid	20	-0.0024	Na ⁺	Dicarboxylic acid
3.81	3.6-4.3	Lactic acid	50		Na ⁺	
*3.75	3.8-4.3	Formic acid	50	+0.0002	Na ⁺ /Li ⁺	
*4.21	4.3-4.8	Butanedioic acid	50	-0.0018	Na ⁺	
*4.76	4.8-5.2	Acetic acid	50	+0.0002	Na ⁺ /Li ⁺	
*5.68	5.0-6.0	Malonic acid	50		Na ⁺ /Li ⁺	Dicarboxylic acid
*7.20	6.7-7.6	Phosphate	50	-0.0028	Na ⁺	Often needs purification before use
*7.55	7.6-8.2	HEPES	50	-0.0140	Na ⁺ /Li ⁺	Zwitterionic
*8.35	8.2-8.7	BICINE	50	-0.0180	Na ⁺	Zwitterionic

Buffer substances for anion exchange chromatography

pKa (25°C)	pH interval	Substance	Conc. (mM)dT	dpKa/ (°C)	Counter-ion	Comments
*4.75	4.5-5.0	N-methyl piperazine	20	-0.015	Cl ⁻	
*5.68	5.0-6.0	Piperazine	20	-0.015	Cl ⁻ /HCOO ⁻	
*5.96	5.5-6.0	L-histidine	20		Cl ⁻	
*6.46	5.8-6.4	bis-Tris	20	-0.017	Cl ⁻	
*6.80	6.4-7.3	bis-Tris propane	20		Cl ⁻	
*7.76	7.3-7.7	Triethanolamine	20	-0.020	Cl ⁻ /CH ₃ COO ⁻	
*8.06	7.6-8.0	Tris	20	-0.028	Cl ⁻	Often needs purification before use and especially sensitive to temperature change.
*8.52	8.0-8.5	N-methyl-diethanolamine	50	-0.028	SO ₂ ⁻ /Cl ⁻ /CH ₃ COO ⁻	
*8.88	8.4-8.8	Diethanolamine	20 at pH 8.4 50 at pH 8.8	-0.025	Cl ⁻	
*8.64	8.5-9.0	1,3-diamino-propane	20	-0.031	Cl ⁻	
*9.50	9.0-9.5	Ethanolamine	20	-0.029	Cl ⁻	
*9.73	9.5-9.8	Piperazine	20	-0.026	Cl ⁻	
*10.47	9.8-10.3	1,3-diamino-propane	20	-0.026	Cl ⁻	
11.12	10.6-11.6	Piperadine	20	-0.031	Cl ⁻	
12.33	11.8-12.0	Phosphate	20	-0.026	Cl ⁻	

* Recommended on the basis of experiments performed in our laboratories.

Table 20. Volatile buffer systems.

pH	Substance	Counter-ion
2.0	Formic acid	H ⁺
2.3-3.5	Pyridine/formic acid	HCOO ⁻
3.0-5.0	Trimethylamine/formic acid	HCOO ⁻
3.0-6.0	Pyridine/acetic acid	CH ₃ OO ⁻
4.0-6.0	Trimethylamine/acetic acid	CH ₃ COO ⁻
6.8-8.8	Trimethylamine/HCl	Cl ⁻
7.0-8.5	Ammonia/formic acid	HCOO ⁻
8.5-10.0	Ammonia/acid	CH ₃ COO ⁻
7.0-12.0	Trimethylamine/CO ₂	CO ₃ ⁻
7.0-12.0	Triethylamine/CO ₂	CO ₃ ⁻
7.9	Ammonium bicarbonate	HCO ₃ ⁻
8.0-9.5	Ammonium carbonate/ammonia	CO ₃ ⁻
8.5-10.5	Ethanolamine/HCl	Cl ⁻
8.9	Ammonium carbonate	CO ₃ ⁻

Test-tube method for selecting starting ionic strengths

1. Set up a series of tubes with ion exchanger as detailed on page 69.
2. Equilibrate the gel in each tube with 0.5 M buffer at the selected starting pH (10 x 10 ml washes).
3. Equilibrate the gel in each tube to a different ionic strength, at constant pH, using a range from 0.05 M to 0.5 M NaCl for Sephadex ion exchangers and from 0.01 M to 0.3 M NaCl for Sephacel and Sepharose ion exchangers. This will require 5 x 10 ml washes. Intervals of 0.05 M NaCl are sufficient.
4. Add sample, mix and assay the supernatant to determine the maximum ionic strength which permits binding of the substance of interest and the minimum ionic strength required for complete desorption.

In the hypothetical example shown in Figure 38 (b) the ionic strength for sample binding (start buffer) would be at most 0.15 M and for elution at least 0.3 M.

10. Experimental Technique

There are three ways of performing an ion exchange separation: by column chromatography, by batch methods, and by expanded bed adsorption. This section will mostly deal with column chromatography.

Column chromatography

Choice of column

Good results in column chromatography are not solely dependent on the correct choice of gel media. The design of the column and good packing technique are also important in realising the full separation potential of any gel. These factors are built into the pre-packed columns supplied by Pharmacia Biotech and should be considered before packing a chromatography column in the laboratory.

Column design

The material used in the construction of the column should be chosen to prevent destruction of labile biological substances and minimize non-specific binding to exposed surfaces. The bed support should be designed so it is easily exchangeable to restore column performance whenever contamination and/or blockage in the column occurs. Bed supports made from coarse sintered glass or glass wool cannot be recommended because they soon become clogged, are difficult to clean and cause artifacts (22). Dead spaces must be kept to a minimum to prevent re-mixing of separated zones.

The pressure specifications of the column have to match the back-pressure generated in the packed bed when run at optimal flow rate. This is particularly important when using high performance media with small bead size.

Pharmacia Biotech has developed a series of standard columns suitable for ion exchange chromatography. All are easy to dismantle and reassemble to allow thorough cleaning, which is a particularly important aspect when handling biological samples.

Further information on the full range of Pharmacia Biotech chromatography columns are available upon request.

Larger chromatography columns, specially designed for pilot and process scale chromatography are also available. Some aspects regarding process scale columns are described in Chapter 11.

Column dimensions

As for most adsorptive, high selectivity techniques, ion exchange chromatography is normally carried out in short columns. A typical ion exchange column is packed to a bed height of 5-15 cm. Once the separation parameters have been determined, scale-up is easily achieved by increasing the column diameter.

Quantity of ion exchanger

The amount of ion exchanger required for a given experiment depends on the amount of sample to be chromatographed and on the available or dynamic capacity of the ion exchanger for the sample substances. For the best resolution in ion exchange chromatography, it is not usually advisable to use more than 10-20% of this capacity, although this value can be exceeded if resolution is adequate. The capacity data given for each specific ion exchanger in respective product Chapter serves as a guideline for calculating the required amount of ion exchanger needed for a given experiment.

Preparation of the ion exchanger

Having chosen the appropriate ion exchanger and starting buffer it is essential that the exchanger is brought to equilibrium with start buffer before sample application. Preparation of Sephadex ion exchangers, which are supplied as powders, differs somewhat from the other ion exchangers available from Pharmacia Biotech, which are supplied pre-swollen and/or pre-packed.

Pre-swollen ion exchangers

SOURCE, Sepharose based, and DEAE Sephacel ion exchange media are supplied ready to use. To prepare the gel, the supernatant is decanted and replaced with starting buffer to a ratio of approximately 75% settled gel to 25% buffer.

If large amounts of ion exchangers are to be equilibrated with a weak buffer, the ion exchanger should first be equilibrated with a 10 times concentrated buffer solution at the correct pH, and then with a few volumes of starting buffer.

Pre-packed ion exchange media

MiniBeads and MonoBeads are supplied pre-packed in PC and HR columns respectively. SOURCE 15 are available pre-packed and ready to use in RESOURCE columns, 1 or 6 ml. Pre-packed HiLoad columns are XK Columns pre-packed with Sepharose Fast Flow and Sepharose High Performance ion exchangers. Sepharose High Performance ion exchangers are also available pre-packed in HiTrap columns, 1 and 5 ml. For pilot scale applications, Mono Q, Mono S and Q Sepharose High Performance are available in pre-packed BioPilot

Columns of 100 ml(35/100) and 300 ml (60/100). SP Sepharose High Performance pre-packed in BioPilot Columns are available on request. For the above mentioned pre-packed columns, the preparation consists of washing out the 20% ethanol packing solution with 5 column volumes of start buffer.

Sephadex ion exchangers

Sephadex ion exchangers should be swollen at the pH to be used in the experiment. Complete swelling takes 1-2 days at room temperature or 2 hours (at pH 7) in a boiling water bath. Swelling at high temperature also serves to de-aerate the gel. Vigorous stirring (e.g. with a magnetic stirrer) and swelling in distilled water should be avoided due to the risk of damaging the beads.

The required amount of ion exchanger should be stirred into an excess of starting buffer. Remove the supernatant and replace with fresh buffer several times during the swelling period. Instead of decantation, the ion exchanger can be washed extensively on a Büchner funnel after the initial swelling.

Alternative counter-ions

If ion exchangers are to be used with counter-ions other than those supplied (i.e. other than sodium or chloride) then the following procedure should be used.

Suspend the required amount of ion exchanger in an excess of 0.5-1.0 M solution of a salt of the new counter-ion. After sedimentation and decantation, re-suspend the ion exchanger in the buffer to be used in the experiment. Decant and re-suspend the ion exchanger in this buffer several times.

Decantation of fines

Decantation of fines is not necessary with any Pharmacia Biotech ion exchangers.

Packing the column

As with any other chromatographic technique, packing is a very critical stage in an ion exchange experiment. A poorly packed column gives rise to poor and uneven flow, zone broadening, and loss of resolution.

Detailed packing instructions are to be found in the instructions supplied with respective media.

Column Packing Video Film

A video film describing the correct methodologies for packing laboratory columns is available and can be ordered from your local distributor of Pharmacia Biotech products.

Checking the packing

The bed should be inspected for irregularities or air bubbles using transmitted light from a lamp held behind the column. Be careful in the choice of any dye substances used for checking beds as many of them are strongly charged. For example, Blue Dextran 2000 binds strongly to anion exchangers.

Testing the bed is easily done by injecting a test substance on the column and calculating the number of theoretical plates (N) or the height equivalent to a theoretical plate (H).

Choose a test substance which shows no interaction with the media and which has a low molecular weight, to give full access to the interior of the beads.

Acetone at a concentration of 1% (v/v) can be used with all kinds of chromatographic media and is easily detected by UV-absorption. Keep the sample volume small to ensure a narrow zone when the sample enters the top of the column. For optimal results, the sample volume should be $\leq 0.5\%$ of the column volume for a column packed with a medium of approximately 30 μm bead diameter and $\leq 2\%$ of the column for a column packed with a medium of approximately 100 μm bead diameter. Keep the linear flow rate low to reduce zone spreading due to non-equilibrium at the front and rear of the zone. For 30 μm media the flow rate should be between 30-60 cm/h and for 100 μm media, 15-30 cm/h. Use the following equations to calculate the number of theoretical plates (N) and the height equivalent to a theoretical plate (H).

$$N = 5.54 \times \left(\frac{V_R}{w_h} \right)^2$$

$$H = L/N$$

where

V_R is the volume eluted from the start of sample application to the peak maximum and w_h is the peak width measured as the width of the recorded peak at half of the peak height, see Figure 44. L is the height of the packed bed.

Measurements of V_R and w_h can be made in distance (mm) or volume (ml) but both parameters must be expressed in the same unit.

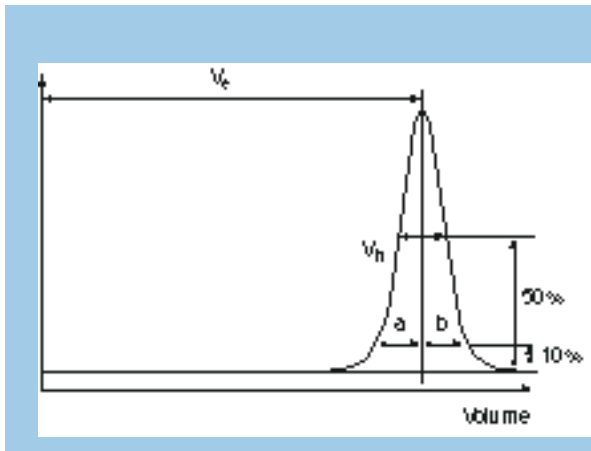

Fig 44. A UV trace for acetone in a typical test chromatogram showing the HETP and A_s value calculations.

As a general rule of thumb, a good H value is about two to three times the mean bead diameter of the gel being packed. For a 90 μm particle packing, this means an H value of 0.018-0.027 cm.

Another useful parameter for testing the packed bed is the symmetry factor (A_s)

$$A_s = \frac{b}{a}$$

where

a = 1st half peak width at 10% of peak height. (see Figure 44)

b = 2nd half peak width at 10% of peak height. (see Figure 44)

A_s should be as close as possible to 1. A reasonable A_s value for a short column such as an IEX column is 0.80-1.80. (For longer gel filtration columns it will probably fall within 0.70-1.30).

An extensive leading edge is usually a sign that the gel has been packed too tightly and extensive tailing is usually a sign that the gel has been packed too loosely.

Equilibrating the bed

Run at least two bed volumes of buffer through the ion exchange bed to allow the system to reach equilibrium. Counter-ion concentration, conductivity, and pH of the eluent should be checked against the ingoing solution. It is often sufficient just to measure the pH of the effluent.

Sample preparation

Sample concentration

The amount of sample which can be applied to a column depends on the dynamic capacity of the ion exchanger and the degree of resolution required. For the best resolution it is not usually advisable to use more than 10-20% of this capacity (23). Information on the available capacities for the different exchangers is given in the relevant product sections. Methods for determining available and dynamic capacities are given later in this chapter.

Sample composition

The ionic composition should be the same as that of the starting buffer. If it is not, it can be changed by gel filtration on Sephadex G-25 using e.g. Pharmacia Biotech Disposable Column PD-10, Fast Desalting Column HR 10/10 or HiTrap Desalting Columns, dialysis, diafiltration or possibly by addition of concentrated start buffer.

Sample volume

If the ion exchanger is to be developed with the starting buffer (isocratic elution), the sample volume is important and should be limited to between 1 and 5% of the bed volume. If however, the ion exchanger is to be developed with a gradient, starting conditions are normally chosen so that all important substances are adsorbed at the top of the bed. In this case, the sample mass applied is of far greater importance than the sample volume. This means that large volumes of dilute solutions, such as pooled fractions from a preceding gel filtration step or a cell culture supernatant can be applied directly to the ion exchanger without prior concentration. Ion exchange thus serves as a useful means of concentrating a sample in addition to fractionating it.

If contaminants are to be adsorbed, and the component of interest is allowed to pass straight through, then the sample volume is less important than the amount of contaminant which is present. Under these conditions there will be no concentration of the purified component, rather some degree of dilution due to diffusion.

Sample viscosity

The viscosity may limit the quantity of sample that can be applied to a column. A high sample viscosity causes instability of the zone and an irregular flow pattern. The critical variable is the viscosity of the sample relative to the eluent. A rule of thumb is to use 4 cP as the maximum sample viscosity. This corresponds to a protein concentration of approximately 5%. Approximate relative viscosities can be quickly estimated by comparing emptying times from a pipette.

If the sample is too viscous, due to high solute concentration, it can be diluted with start buffer. High viscosity due to nucleic acid contaminants can be alleviated by precipitation with a poly-cationic macromolecule such as polyethyleneimine or protamine sulphate. Nucleic acid viscosity can also be reduced by digestion with endonuclease. Such additives may however be less attractive in an industrial process since they will have to be proven absent from the final product.

Sample preparation

In all forms of chromatography, good resolution and long column life time depend on the sample being free from particulate matter. It is important that “dirty” samples are cleaned by filtration or centrifugation before being applied to the column. This requirement is particularly crucial when working with small particle matrices, such as MiniBeads (3µm), MonoBeads (10 µm), SOURCE (15 and 30 µm) and Sepharose High Performance (34µm).

The “grade” of filter required for sample preparation depends on the particle size of the ion exchange matrix which will be used. Samples which are to be separated on a 90 µm medium can be filtered using a 1 µm filter. For 3, 10, 15, 30 and 34 µm media, samples should be filtered through a 0.45 µm filter. When sterile filtration or extra clean samples are required, a 0.22 µm filter is appropriate.

Samples should be clear after filtration and free from visible contamination by lipids. If turbid solutions are injected onto the column, the column lifetime, resolution and capacity can be reduced. Centrifugation at 10 000 g for 15 minutes can also be used to prepare samples. This is not the ideal method of sample preparation but may be appropriate if samples are of very small volume or adsorb non-specifically to filters.

Note: The latter may indicate that the substance in question may also adsorb strongly to chromatography matrices. Care should therefore be taken and perhaps a buffer additive such as glycerol or a detergent used.

Crude samples containing lipids, salts, etc. can be passed through a suitably sized column of Sephadex G-25 e.g. Pharmacia Biotech Desalting Column PD-10, Fast Desalting Column HR 10/10 or HiTrap Desalting Column. Preliminary sample clean-up can be achieved simultaneously in this way.

In expanded bed adsorption sample preparation is not as crucial as for column chromatography. Samples can be applied directly to the expanded bed without prior sample preparation, e.g. filtration, centrifugation etc. (Expanded bed adsorption is described in detail on page 98.)

Sample application

There are a number of ways to apply the sample.

Sample application with an adaptor

This is the recommended method for all ion exchange media with the exception of Sephadex based media and is always the method used with pre-packed columns or when upward elution is employed. The sample may be applied to the column via the adaptor in one of the following ways.

Sample loops are a convenient way of applying small samples in a reproducible manner without interrupting the liquid flow on the column. Sample loops can be used in conjunction with LV-4 or SRV-4 valves (Fig. 45) or in conjunction with the manual valves V-7 and IV-7 or the motorized valves MV-7 and IMV-7 (Fig. 46).

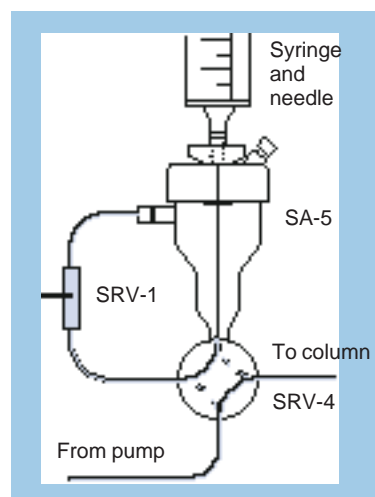

Fig. 45. Sample application using an SA-5 in a sample loop system.

Sample applicators SA-5, SA-50. These are reservoirs which, used in combination with a suitable valve, e.g. SRV-4, allow the sample to be introduced via a closed sample loop system using a pump (Fig. 45). As well as their large capacity (up to 6 ml for the SA-5 and 45 ml for the SA-50) the sample applicator offers the advantage of serving as a pulse damper and bubble trap.

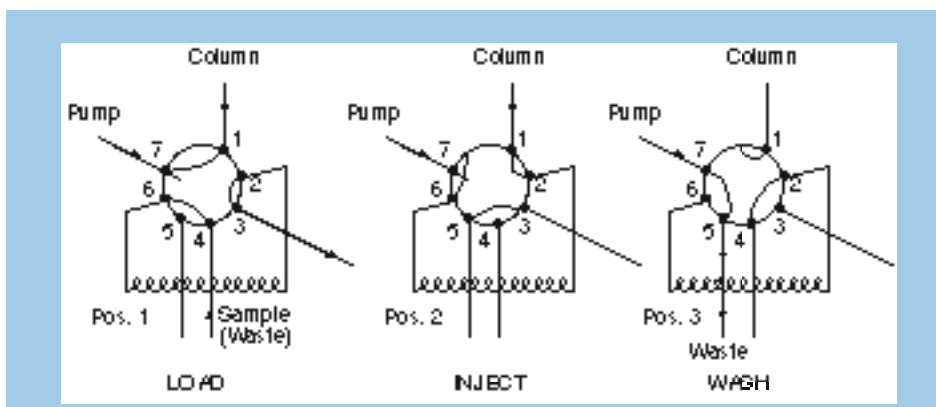

Fig. 46. Sample application using V-7, IV-7 or motorized MV-7 or IMV-7 valves.

Superloops can be used together with the manual valves V-7 and IV-7 or the motorised valves MV-7 and IMV-7 when larger volumes of sample have to be applied (Fig. 47). Superloops are available with capacities of 10, 50 and 150 ml. (The 150 ml Superloop is most often used in BioPilot System.)

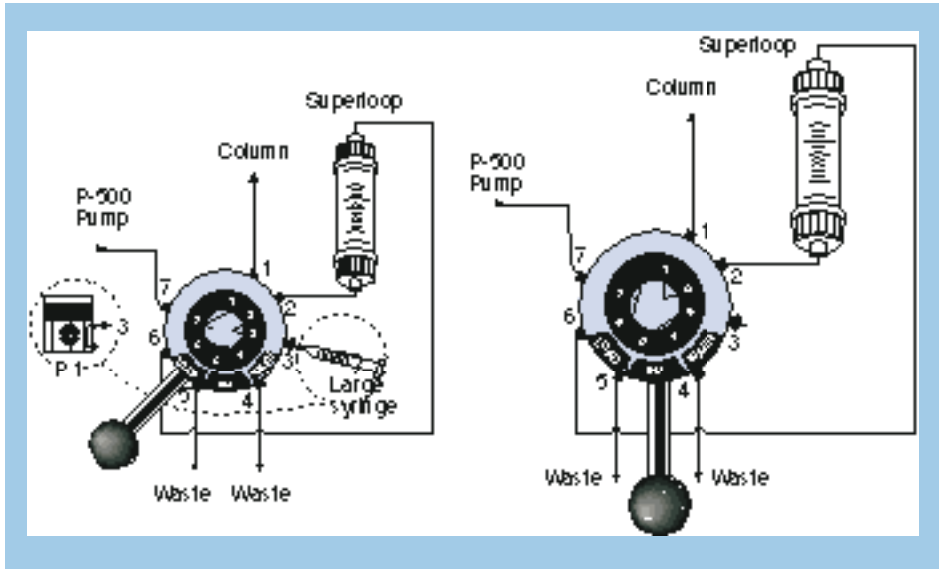

Fig. 47. Sample application using a Superloop.

Syringe method (Fig. 48). The valves LV-3 and LV-4 can be used as syringe holders to give a very simple method for the application of small samples in standard chromatography. Using this method the sample is allowed to run onto the column under gravity.

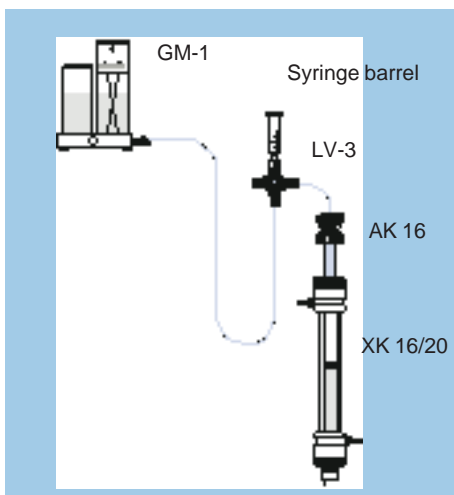

Fig. 48. Sample application using a syringe.

Sample reservoir (Fig. 49). In a similar way, a sample reservoir (e.g. R9, RK 16/26) can be connected via a 3-way valve to apply larger samples.

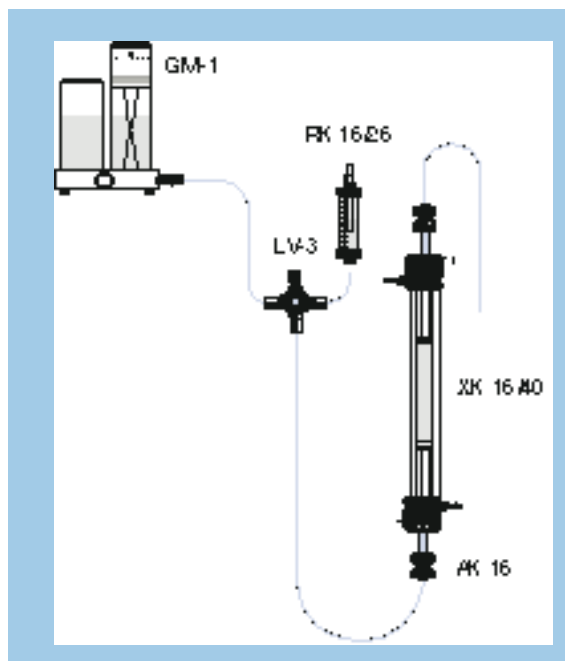

Fig. 49. Sample application using a reservoir. This is also an example of upward elution.

Other methods of sample application

The following methods can be used with Sephadex based ion exchangers where it is not recommended to use an adaptor due to the variability of the bed height. They are not recommended for the more rigid ion exchanger types.

Sample application onto a drained bed

This method requires the least equipment but is very difficult to do well. Allow eluent to drain to the bed surface, then pipette the sample onto the gel surface and allow it to drain into the gel. When all the sample has entered the bed, the top of the column is washed with aliquots of starting buffer and is connected up for elution. The drawback with this system is that disturbances to the bed surface result in uneven sample application and band skewing.

Sample application under the eluent

Here excess eluent is left on top of the column. Some very thin capillary tubing is attached to a syringe and the free end is flared by gentle heating. The syringe is filled with sample which is then layered on top of the bed by positioning the end of

the tubing just above the surface and slowly pressing out the sample. Note that the sample must be denser than the eluent or made denser by the addition of a sugar, e.g. glucose (24). The column can then be connected for elution.

Elution

If starting conditions are chosen such that only unwanted substances in the sample are adsorbed, then no change in elution conditions is required since the substance of interest passes straight through the column. Similarly no changes are required if sample components are differentially retarded and separated under starting conditions. This procedure is termed isocratic elution, and the column is said to be developed under starting conditions. Isocratic elution can be useful since no gradient apparatus is required for the run and, if all retarded substances elute, regeneration is not required.

Normally, however, separation and elution are achieved by selectively decreasing the affinity of the solute molecules for the charged groups on the gel by continuously changing either buffer pH or ionic strength or possibly both. This procedure is termed gradient elution.

Change of pH

As shown in Figure 37 on page 68, the net charge on a molecule depends on pH. Thus altering the pH towards the isoelectric point of a substance causes it to lose its net charge, desorb, and elute from the ion exchanger. Figure 50 shows use of a decreasing pH gradient in separation of haemocyanin fractions (25).

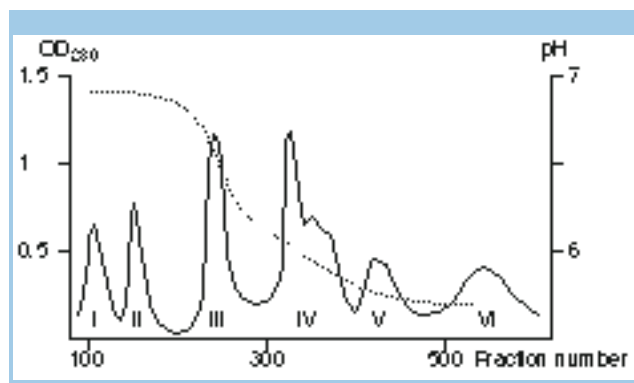

Fig. 50. Elution pattern of whole stripped haemocyanin on DEAE Sepharose CL-6B. Sample applied in 0.1 M sodium phosphate buffer pH 6.8 and eluted with decreasing pH gradient (25). (Reproduced by kind permission of the authors and publisher.)

Since many proteins show minimum solubility in the vicinity of their isoelectric points, care and precautions must be exercised to avoid isoelectric precipitation on the column. The solubility of the sample components at the pH and salt concentrations to be used during separation should always be tested in advance.

Change of ionic strength

At low ionic strengths, competition for charged groups on the ion exchanger is at a minimum and substances are bound strongly. Increasing the ionic strength increases competition and reduces the interaction between the ion exchanger and the sample substances, resulting in their elution. Figure 51 shows the elution of mouse IgM on SP Sepharose Fast Flow using a concentration gradient of NaCl.

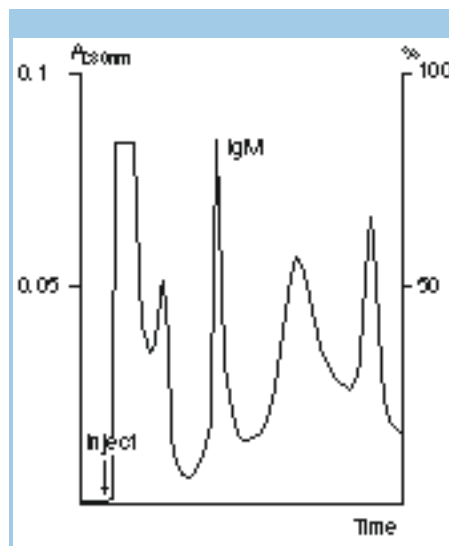

Fig. 51. Isolation of mouse IgM on SP Sepharose Fast Flow. (Courtesy of Dr. H. F. J. Savelkoul, Erasmus University, Rotterdam, The Netherlands.)

Gradient direction

Guidelines for the choice of ascending or descending gradients are given in Table 21.

Table 21. Choosing the direction of the gradient for elution.

Ion exchanger	Direction of pH gradient	Direction of ionic strength gradient
Anion exchanger	decreasing	increasing
Cation exchanger	increasing	increasing

Choice of gradient type

The components in the sample usually have different affinities for the ion exchanger and so variations in the pH and ionic strength of the eluent can cause their elution at different times and thus their separation from each other. One can choose to use either continuous or stepwise gradients of pH or ionic strength.

Stepwise pH gradients are easier to produce and are more reproducible than linear pH gradients. In the case of weak ion exchangers the buffer may have to titrate the ion exchanger and there will be a short period of re-equilibration before the new pH is reached. Gradients of pH can be also used in combination with ionic strength gradients.

Stepwise ionic strength gradients are produced by the sequential use of the same buffer at different ionic strengths. Stepwise elution is technically simple and offers the potential of high resolution in preparative applications. Care must be exercised in the design of the steps and the interpretation of results since substances eluted by a sharp change in pH or ionic strength elute close together. Peaks tend to have sharp fronts and pronounced tailing since they frequently contain more than one component. Tailing may lead to the appearance of false peaks if a buffer change is introduced too early. For these reasons a first separation using a continuous gradient is always recommended as a means of characterising the sample and an indication of suitable steps. The differences between continuous and stepwise gradient elution are shown in Figure 52.

Continuous pH gradients are difficult to produce at constant ionic strength, since simultaneous changes in ionic strength, although small, also occur. Linear pH gradients cannot be obtained simply by mixing buffers of different pH in linear volume ratios since the buffering capacities of the systems produced are pH dependent. A relatively linear gradient can be produced over a narrow pH interval (Max. 2 pH units) by mixing two solutions of the same buffer salt adjusted, respectively, to 1 pH unit above and 1 pH unit below the pK_a for the buffer.

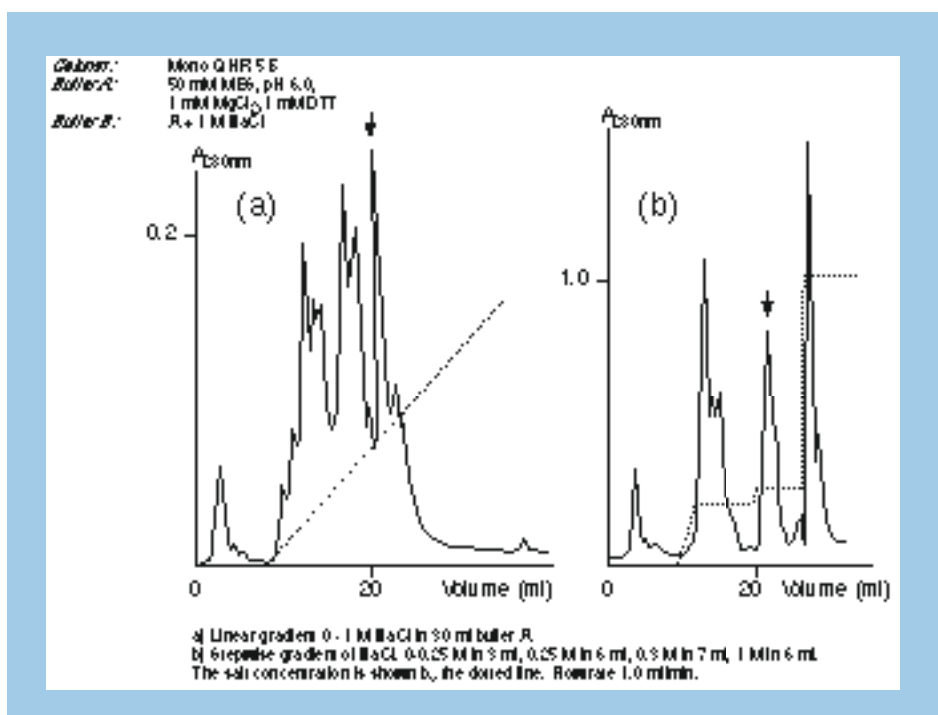

Fig. 52. Continuous and stepwise gradient elution of β -galactosidase from *Escherichia coli* on Mono Q HR 5/5 (26). (Reproduced by kind permission of the authors and publisher.)

Continuous ionic strength gradients are the most frequently used type of elution in ion exchange chromatography. They are easy to prepare and very reproducible. Two buffers of differing ionic strength, the start and limit buffers, are mixed together and if the volume ratio is changed linearly, the ionic strength changes linearly.

The limit buffer may be of the same buffer salt and pH as the start buffer, but at higher concentration, or the start buffer containing additional salt e.g. NaCl.

Gradient elution generally leads to improved resolution since zone sharpening occurs during elution. In all forms of isocratic elution, a limiting factor with regards to achievable resolution is zone broadening as a result of longitudinal diffusion. In gradient elution, the leading edge of a peak is retarded if it advances ahead of the salt concentration or pH required to elute it. In contrast the trailing edge of the peak is exposed to continuously increasing eluting power. Thus the trailing edge of the peak has a relatively higher speed of migration, resulting in zone sharpening, narrower peaks and better resolution.

Gradient elution also reduces zone broadening by diminishing peak tailing due to non-linear adsorption isotherms.

Resolution using a continuous gradient

To optimize a separation it is important first to consider the objectives of the experiment, since the desired features of a separation i.e. speed, resolution and capacity, are often mutually exclusive. In the case of ion exchange separations the speed of separation is not solely related to the flow rate used in the experiment but also to the steepness or slope of the gradient applied.

Novotny (27) has shown that the retention of charged molecules on an ion exchange column is related to the volume of the column and the molarity difference across it. This means that long shallow gradients will give maximum separation between peaks but that the separation time will be longer and peak broadening larger. In contrast short steep gradients will give faster separations and sharper peaks but the retention differences between peaks will be reduced. The effect of gradient slope on resolution is illustrated in Figure 53.

It should be remembered that the sample loading also has a major influence on resolution since the width of the peaks is directly related to the amount of substance present.

In practice it is recommended that trial experiments be carried out to allow the selection of optimal run parameters in terms of gradient shape and length.

As a general rule a gradient of 0.05 to 0.5 M salt over a volume of 10 to 20 column volumes at the flow rate recommended for the medium (see individual media sections) can be used for initial investigative separations.

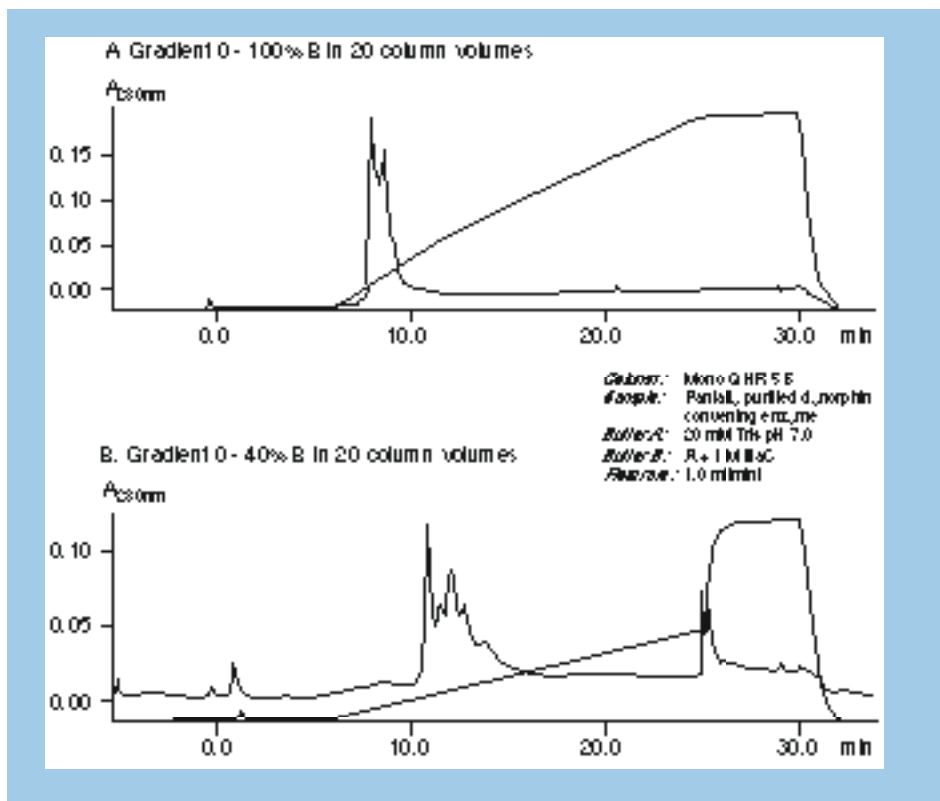

Fig. 53. Effect of gradient slope on resolution. (Work by Pharmacia Biotech, Uppsala, Sweden).

Choice of gradient shape

Linear Gradients. It is strongly recommended that initial experiments with a new separation problem be carried out using linear gradient elution. The results obtained can then serve as a base from which optimization can be planned. If better resolution is required then the separation can be improved by altering the shape or slope of the gradient.

Convex gradients can be used to improve resolution in the last part of the gradient or to speed up a separation when the first peaks are well separated and the last few are adequately separated.

Concave gradients can be used to improve resolution in the first part of the gradient or to shorten the separation time when peaks in the latter part of the gradient are more than adequately separated.

Complex gradients can be generated to use the maximum resolution offered by isocratic resolution when required combined with steeper gradient portions where resolution is adequate or unnecessary (Fig. 54). Complex gradients offer the maximum flexibility in terms of combining resolution with speed during the same separation. A knowledge of the chromatographic behaviour of the sample obtained from previous separations using simpler gradients is essential.

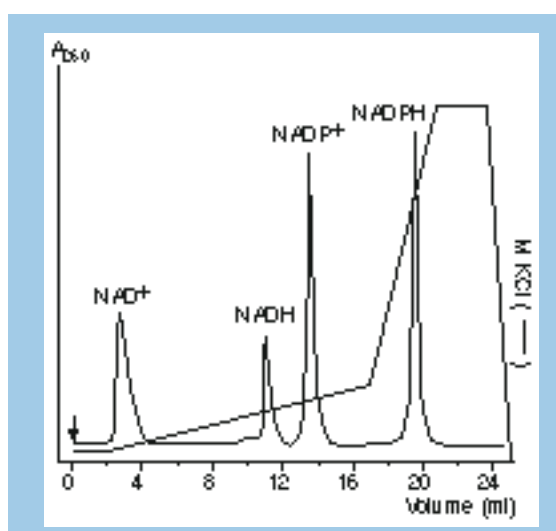

Fig. 54. Anion exchange chromatography of a mixture of pyridine nucleotides on Mono Q (28): Sample, 100 μ l of 100 μ M NAD, 100 μ M NADH, 250 μ M NADP and 250 μ M NADPH; column, Mono Q HR 5/5; buffer A, 20 mM triethanolamine, pH 7.7; buffer B, buffer A with 1.0 M KCl; gradient, 0% B for 2 ml, 0-20% B in 15 ml, 20-100% B in 5 ml, 100% B for 3 ml; flow rate, 1 ml/min.

Sample displacement

When a sample of solutes, such as proteins, is applied to the top of an ion exchange column the species with the highest charge density will bind at the top, displacing more weakly bound species or preventing such from binding.

In effect a degree of separation occurs on the column during sample loading, with the solutes stacked on the column in order of their relative charges and strengths of binding.

On application of a gradient the increasing salt concentration will cause the most weakly bound molecules to migrate and leave the column first. For this reason “reverse flow elution” should never be used in the ion exchange separation of complex mixtures. Under such conditions early desorbing substances would have to migrate through all other bound species, possibly displacing them, and lead to lost resolution.

Gradient generation

Accurate and reproducible pH and ionic strength gradients are best formed using purpose designed equipment. The choice of gradient generating system will depend upon the type of ion exchange media and the required complexity of the gradient.

Gradient formation with two pumps or a single pump in combination with a switch valve

Maximum flexibility in terms of gradient production is achieved by using two separate pumps for start and limit buffers or a single pump in combination with a switch valve.

Using gradient programmers, e.g. GP-250 Plus or LCC-501 Plus, or using chromatography systems which are controlled via a controlling software, e.g. UNICORN and FPLCdirector, the proportions of the start and limit buffers which constitute the eluent being supplied to the column are programmed for specific times or volumes during the separation. The relative amounts of start and limit buffer then increase or decrease in a linear fashion between two such “breakpoints” to produce the gradient. The more breakpoints which have been programmed the more complex the gradient.

Further information on controlling software, gradient programmers and related pump systems is available from Pharmacia Biotech.

Gradient Mixer

The Pharmacia Gradient Mixer GM-1 can be used to make linear ionic strength or pH gradients of up to 500 ml in volume (Fig. 55). The mixing chamber should contain the starting buffer and the other chamber the limiting buffer. Although the Gradient Mixer GM-1 will not produce linear pH gradients it can be used to form reproducible continuous pH gradients from two solutions of different pH and similar ionic strength.

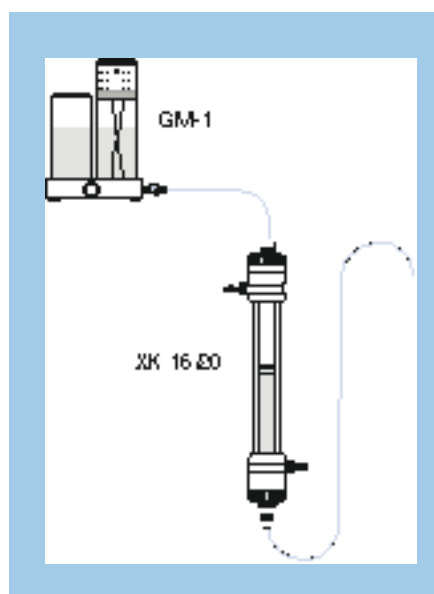

Fig. 55. Gradient elution system using the Gradient Mixer GM-1.

An example of a decreasing pH gradient produced by the Gradient Mixer GM-1 is shown in Figure 56. The gradient was produced from 0.1 M solutions of Tris (free base), pH 10.5 and Tris-HCl, pH 7.5.

Usually changes in pH also produce small changes in ionic strength. These can be estimated by monitoring conductivity.

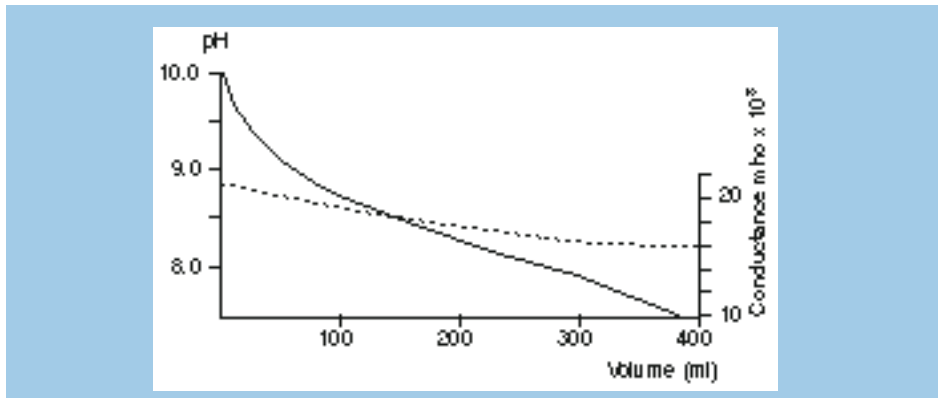

Fig. 56. Gradient from pH 10.5 to 7.5 in 400 ml produced using the Gradient Mixer GM-1. pH —, conductance - - -. (Work by Pharmacia Biotech, Uppsala, Sweden.)

Batch separation

There is essentially no difference in separation procedure between a column developed by stepwise elution and a batch procedure. Either the substance of interest or contaminants may be attached to the ion exchanger.

Although batch procedures are less efficient than column techniques they may offer advantages in particular cases. When very large sample volumes with low protein concentration have to be processed, the sample application time on a column can be very long and filtration of such a large sample can also be rather difficult to perform. Binding the sample in batch mode will be much quicker and there will be no need to remove particulate matter.

A batch procedure can also be an attractive approach if high sample viscosity generates high back-pressure in a column procedure or if high back-pressure is generated by contaminants such as lipids, which may cause severe fouling and clogging of the column.

Batch separation is a very rapid technique and no technical difficulties are caused by the swelling or shrinkage of Sephadex ion exchangers. The shrinkage may even be an advantage in some applications.

When working with batch ion exchange, the starting conditions are selected in the same way as in column chromatography, i.e. choose buffer pH and ionic strength to bind the substance of interest but to prevent as many contaminants as possible from binding.

To maximize recovery, the starting conditions should be selected so that the protein of interest binds much stronger than is usual in column chromatography. Unless the protein adsorbs to 100%, losses during subsequent washing will be inevitable, especially if the volume of liquid is large compared to the volume of adsorbent. To keep recovery high, the pH in a batch experiment may have to be several units away from the isoelectric point of the protein.

Batch separation is carried out by stirring the ion exchanger previously equilibrated in the appropriate buffer with the solution to be treated until the mixture has reached equilibrium. This usually takes about one hour. The slurry is then filtered and washed with the buffer solution. In cases of incomplete adsorption this procedure should be repeated on the filtrate with a new batch of ion exchanger. Then elution buffer is added (1-2 times the volume of the sedimented gel) and stirred until desorption is complete, which can take up to 30 minutes or more. Finally, suction is used to filter the buffer containing the desorbed product of interest from the adsorbent. The gel can also be packed in a column after the washing step and be eluted stepwise in the same way as during normal column chromatography. Resolution will however be lower for such a combined batch and column procedure compared with a normal column procedure, since the sample is bound uniformly throughout the gel slurry and the subsequent chromatographic bed. Under these conditions stepwise elution is recommended since gradient elution will give broad bands and poor resolution.

Batch chromatography is very useful for concentrating dilute solutions and separating the substances of interest from gross contaminants during the initial stages of a purification scheme.

Note: Fines will be generated if the ion exchangers are stirred too vigorously. This will increase the time required for filtration.

Expanded bed adsorption

Expanded bed adsorption is a unit operation that uses STREAMLINE adsorbents and columns for recovering proteins directly from crude samples. Proteins are recovered in a single pass without the need for prior clarification. STREAMLINE has proven effective in purification of proteins from fermentation or cell culture in extracellular processes, and has demonstrated its suitability when used with broth from cell lysis and homogenization in intracellular processes with soluble proteins. STREAMLINE reduces the number of operations in a process by fusing the functions of clarification, concentration and capture (see page 109) in one operation.

It offers the selectivity afforded by chromatography, the throughput of ultra-filtration and the convenience of small scale centrifugation.

Crude feed from the fermentor containing the desired product and undesired cells, cell debris and particulates is applied to the expanded bed. Target products are bound by the adsorbent while particulates and contaminants pass through unhindered. The desired molecule is then eluted as in packed bed chromatography.

Expanded bed technology

Expanded bed adsorption is based on fluidization. The sedimented bed begins to expand as the adsorbent particles are raised by an upward liquid flow. The difference between a fluidized bed and expanded bed is that in an expanded bed the adsorbent particles display very little back-mixing. This is achieved through the unique design of the column and the adsorbents. The column has a special flow distributor at the bottom, the adsorbent particles have a well-defined size and density distribution. The particles are kept in suspension by the balance between upward flow rate and particle sedimentation velocity. As the bed expands with the upward liquid flow, the movement of any given particle is very small. This creates a stable, homogeneous expanded bed and a liquid flow which is characterized by a constant velocity profile, i.e. plug flow. The stability of the expanded bed give STREAMLINE characteristics that are similar to those of a packed bed in chromatography.

Basic principle of operation

1. STREAMLINE adsorbent is poured into STREAMLINE column and allowed to sediment (Fig. 57 a).
2. An upward liquid flow of equilibration buffer is applied to the column and STREAMLINE adsorbent particles are suspended in the flow, creating a stable fluidized bed (Fig. 57 b).
3. The sample, a mixture of soluble proteins, contaminants, cells, or cell debris, is passed upwards through the expanded bed. The target proteins are bound on STREAMLINE adsorbent while particulates and contaminants pass through the expanded bed unrestricted. Loosely bound material is washed out with the upward flow of the buffer (Fig. 57 c).
4. The liquid flow is reversed to downward flow. By using suitable buffer conditions, the bound proteins are eluted from STREAMLINE adsorbent in a sedimented bed mode. The eluate contains the target proteins, increased in concentration, free from particulates and ready for further purification (Fig. 57 d).

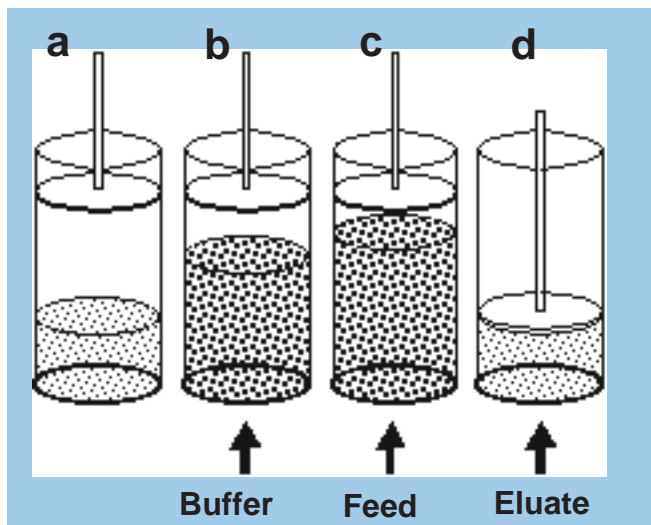

Fig. 57. The principle of operation of expanded bed adsorption.

STREAMLINE adsorbents

STREAMLINE adsorbents are described in detail in Chapter 6.

STREAMLINE columns

STREAMLINE columns are designed to suit the different stages of process development. STREAMLINE 50 column is designed for method optimization. A set-up with this column can handle 1-20 l from the fermentor at a throughput of 6 l/h. A set-up with STREAMLINE 200 column, for pilot scale and verification of the optimized methods, can handle 50-300 l of sample at a throughput of 100 l/h. STREAMLINE CD column, custom designed for industrial manufacturing, can handle production volumes of samples at a throughput of several thousands of litres per hour.

Auxiliary equipment

To operate expanded bed adsorption in method optimization some auxiliary equipment is needed. For example, a peristaltic pump, manual valves, UV, pH and conductivity monitors and a recorder, all standard laboratory equipment. For production installations STREAMLINE is engineered to your specifications.

Regeneration

After each cycle, bound substances must be washed out from the column to restore the original function of the media. Ion exchange adsorbents can normally be regenerated after each run by washing with a salt solution until an ionic strength of about 2 M has been reached. This should remove any substances bound by ionic forces. The salt should contain the counter-ion to the ion exchanger to facilitate equilibration.

To prevent a slow build up of contaminants on the column over time, more rigorous cleaning protocols may have to be applied on a regular basis, see below.

Cleaning, sanitization and sterilization procedures

Cleaning

Cleaning-in-place (CIP) is the removal from the purification system of very tightly bound, precipitated or denatured substances generated in previous purification cycles. In some applications, substances such as lipids or denatured proteins may remain in the column bed instead of being eluted by the regeneration procedure. If contaminants accumulate on the column over a number of purification cycles, they may affect the chromatographic properties of the column. If fouling is severe, it may also block the column, increasing the back-pressure and reducing the flow rate.

A specific CIP protocol should be designed according to the type of contaminants that are known to be present in the sample. NaOH is a very efficient cleaning agent that can be used for solubilizing irreversibly precipitated proteins and lipids. NaOH can effectively be combined with solvent or detergent based cleaning methods.

Sanitization

Sanitization is the inactivation of microbial populations. When a packed column is washed with a sanitizing agent, the risk of contaminating the purified product with viable micro-organisms is reduced. The most commonly used sanitization method in chromatography today is to wash the column with NaOH. NaOH has a very good sanitizing effect and also has the additional advantage of cleaning the column.

Sterilization

Sterilization, which is not synonymous with sanitization, is the destruction or elimination of all forms of microbial life in the system.

Protocols for cleaning-in-place (CIP), sanitization and sterilization.

Suggested protocols for cleaning-in-place (CIP), sanitization and sterilization that can be applied to each specific ion exchanger from Pharmacia Biotech are summarized below.

SOURCE and Sepharose based ion exchangers

CIP, sanitization and sterilization protocols for SOURCE and Sepharose based ion exchangers media are summarized in Table 22.

Table 22. Suggested CIP, sanitization and sterilization protocols for SOURCE 15 and 30, and Sepharose based ion exchangers media from Pharmacia Biotech.

Purpose	Procedure
Removal of precipitated proteins	4 bed volumes of 0.5-1.0 M NaOH at 40 cm/h followed by 2-3 bed volumes of water.
Removal of strongly bound hydrophobic proteins, lipoproteins and lipids	4-10 bed volumes of up to 70% ethanol or 30% isopropanol followed by 3-4 bed volumes of water. or 1-2 bed volumes of 0.5% non-ionic detergent (e.g. in 1 M acetic acid) followed by 5 bed volumes of 70% ethanol to remove the detergent, and 3-4 bed volumes of water.
Sanitization	0.5-1.0 M NaOH with a contact time of 30-60 min.
Sterilization	Autoclave the medium at 121 °C for 15 min.

MonoBeads and MiniBeads columns

Due to the small particle size of MonoBeads and MiniBeads, they are more sensitive to particulate matter such as precipitated proteins from the sample or buffer solutions than the larger bead size matrices. Preventative measures to ensure cleanliness of the sample and buffers are essential to ensure long column life. Sample preparation procedures are described earlier in this Chapter. Should precipitated material be present, as indicated by a decrease in performance or an increase in back-pressure, the columns may be cleaned using the detailed instructions included with the column.

DEAE Sephacel and Sephadex based ion exchangers

Due to the relatively large volume changes of Sephadex based gels in different solvents, we recommend cleaning and washing with organic solvents on a Büchner funnel, since the gel needs to be repacked after such treatment.

Remove ionically bound proteins by washing the column with 0.5-1 bed volume of a 2 M NaCl solution.

Remove precipitated proteins, hydrophobically bound proteins and lipoproteins by washing the column with 0.1 M NaOH solution, contact time 1-2 hours, followed by binding buffer until free from alkali. Alternatively, wash the column with 2 bed volumes of 6 M guanidine hydrochloride.

Strongly hydrophobically bound proteins, lipoproteins and lipids can be removed by washing the gel with up to 70% ethanol or 30% isopropanol. Alternatively, wash the gel with 2 bed volumes of a non-ionic detergent in a basic or acidic solution. Use for example, 0.1-0.5% non-ionic detergent (e.g. Triton X-100) in 0.1 M acetic acid. After treatment with detergent always remove residual detergents by washing with 5 bed volumes of 70% ethanol.

Re-equilibrate the ion exchanger with starting buffer.

Storage of gels and columns

Prevention of microbial growth

As well as endangering the sample, bacterial and microbial growth can seriously interfere with the chromatographic properties of ion exchange columns and may obstruct the flow through the bed. During storage an antimicrobial agent should always be added to the ion exchanger. Antimicrobial agents may be eluted from the columns during equilibration before starting a run.

Recommended antimicrobial agents for anion exchangers:

Equilibrate the column with 20% ethanol in 0.2 M acetate.

Recommended antimicrobial agents for cation exchangers:

Equilibrate the column with 20% ethanol or 0.01 M NaOH.

Storage of unused media

Unused media should be stored in closed containers at +4 °C to +25 °C. Note that it is important that the media are not allowed to freeze as the structure of the beads may be disrupted by ice crystals. This disruption will generate fines.

Storage of used media

Used media should be stored at a temperature of +4 °C to +8 °C in the presence of an antimicrobial agent, e.g. 0.01 M NaOH or 20% ethanol according to the recommendation given above. Note that it is important that the media are not allowed to freeze as the structure of the beads may be disrupted by ice crystals. This disruption will generate fines.

Storage of packed columns

Packed columns should be stored at a temperature of +4 °C to +8 °C in the presence of an antimicrobial agent, e.g. 0.01 M NaOH or 20% ethanol according to the recommendation given above. For long-term storage, the packed column should be thoroughly cleaned before equilibration with the storage solution. Recycling the storage solution through the column or flushing the column once a week with fresh storage solution is recommended to prevent bacterial growth.

Determination of the available and dynamic capacities

The available capacity of an ion exchanger can be determined by a batch test-tube method similar to that used for the determination of suitable buffer pH and binding and elution ionic strengths, see page 70 and Figure 38. In this case a series of solutions with different concentrations of the protein are added to a known quantity of ion exchanger, equilibrated at a suitable binding pH and ionic strength. Assaying the supernatants after mixing will show the maximum protein concentration which can be bound per ml of ion exchanger.

For a more realistic and useful measurement of the available capacity of an ion exchanger, a dynamic method is recommended (see page 18 for definition of available and dynamic capacity). The type of equipment necessary for this determination is shown in Figure 58. FPLC System can also be used for this determination.

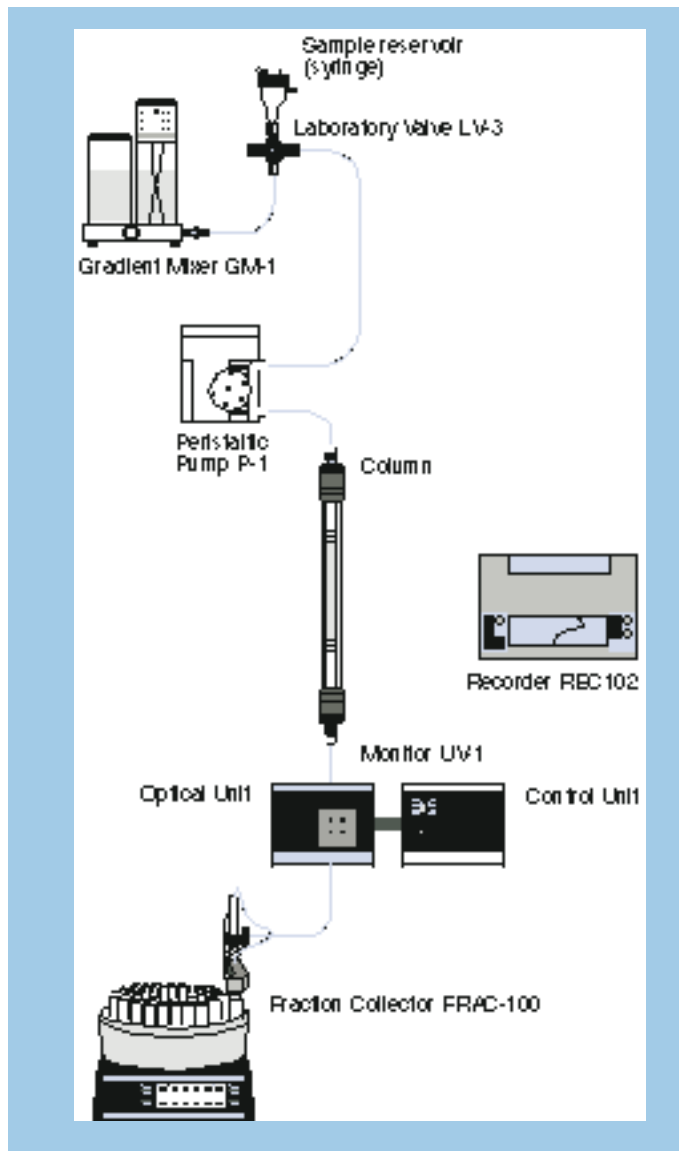

Fig. 58. Experimental set-up for the determination of the dynamic capacity of an ion exchanger.

A defined amount of gel is introduced into the column (Normally a quantity of gel to give a bed volume of approximately 1 ml is sufficient). The gel is packed and equilibrated until the eluate is of the same pH as the starting buffer. The exact volume of gel is calculated from the known column diameter and the measured bed height. In the case of a pre-packed column the amount of gel is already pre-determined.

The protein solution (1 to 5 mg/ml in start buffer) is applied to the column by switching the sample application valve. To ensure that the column is fully loaded,

sample application is not interrupted until the recorder shows 50% full scale deflection, FSD, (0% = starting buffer; 100% = the protein solution in starting buffer).

Sample application is stopped by re-setting the valve to allow passage of start buffer. Washing is continued until 0% full scale deflection is approached (Fig. 59).

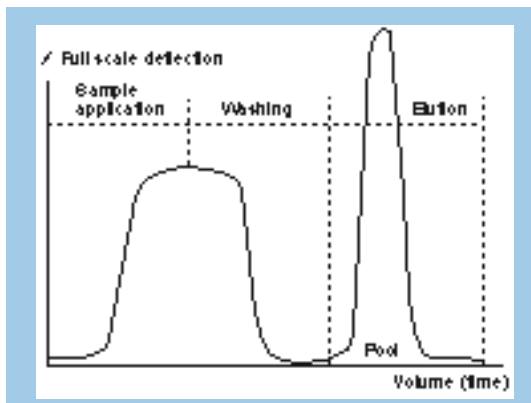

Fig. 59. Graph obtained with the set-up in Figure 58 used in the determination of dynamic capacity.

After the wash phase, adsorbed protein is eluted with a stepwise change in ionic strength (e.g. 2 M NaCl) or pH. Fractions are collected as long as the UV-absorption is above 2% FSD. These fractions are pooled and the UV-absorption of the pool is measured.

Calculation

The maximum amount of protein that can be bound to the column (A) at the chosen flow rate is:

$$A = C \times V$$

C = The protein concentration in the pooled fractions (mg/ml).

V = volume of pooled fractions.

$$C = A_{280} / E$$

A_{280} = absorbance of solution at 280 nm in 1 cm cell.

E = absorbance of standard solution (1 mg/ml) at 280 nm in a 1 cm cell.

The protein capacity is calculated as:

$$A / \text{gel volume}$$

This calculation assumes that the recovery of bound protein from the column is 100%. This can be checked by comparison with the quantity of protein applied to the column.

11. Process considerations

When an ion exchange step is to be part of a purification sequence for a manufacturing process (in contrast to analytical chromatography or small scale preparative applications), method development work has to find conditions which give the highest throughput with the highest yield and the lowest possible cost.

"What kind of application will the product be used in?"

What are the purity issues in relation to the source material and intended use of final product? What has to be removed?

"What kind of starting material do I have?"

What are the major "Headaches"?

"What final scale am I thinking of?"

What consequences will this have for the technical approach?

"What is my purification strategy?"

First, CAPTURE

What will be the major purpose for the initial chromatographic step? Is my proposal rational?

Then, INTERMEDIATE PURIFICATION

What will be the major purpose with each subsequent chromatographic step?

Finally, POLISHING

What will be the major purpose of the polishing stage? Looking back upstream, does the overall balance and sequence of techniques appear logical?

"How do I get the most out of my process?"

Will my process be more productive, safe, robust, economic and easier to use than one which our competitors could do?

Will I arrive at the final process faster than our competitors?

Fig. 60. Questions that must be addressed to assure a rational process design

The design must ensure that the purity requirements of the final product are met, and also considering the special safety issues involved in production of biopharmaceuticals, such as infectious agents, pyrogens, immunogenic contaminants and tumorigenic hazards. In general, the purity issues must be addressed in relation to the nature of the source material and the intended use of the final product. It is important to define the impurities and contaminants which have to be removed from the source material during downstream processing.

Another important aspect of process development is to assure that scalability, robustness and consistency are designed into the process from the very beginning. This is secured by careful selection of appropriate chromatography media, by the way a particular chromatographic step is optimized and by an early identification of different sources of variation and how they can be eliminated or controlled during processing.

To assure a rational process design, a number of questions must be addressed. These questions are summarized in Figure 60 and will be discussed below.

Defining the purpose

To reach the targets for yield and purity in as few steps as possible, and with the simplest possible design, it is not efficient to add one step to another until the purity requirements have been fulfilled. Instead a specific purpose is assigned to each step which is included in the complete scheme. The specific purification problem associated with a particular step, will depend greatly on the characteristics of the ingoing feed material to be processed in the step. Thus, the purpose of a particular step depends on if it is placed at the beginning, to handle a crude feed stock, in the middle, after partial purification or at the end when final purity is achieved.

The different stages in downstream processing can be divided into **capture**, **intermediate purification** and **polishing** (Fig. 61).

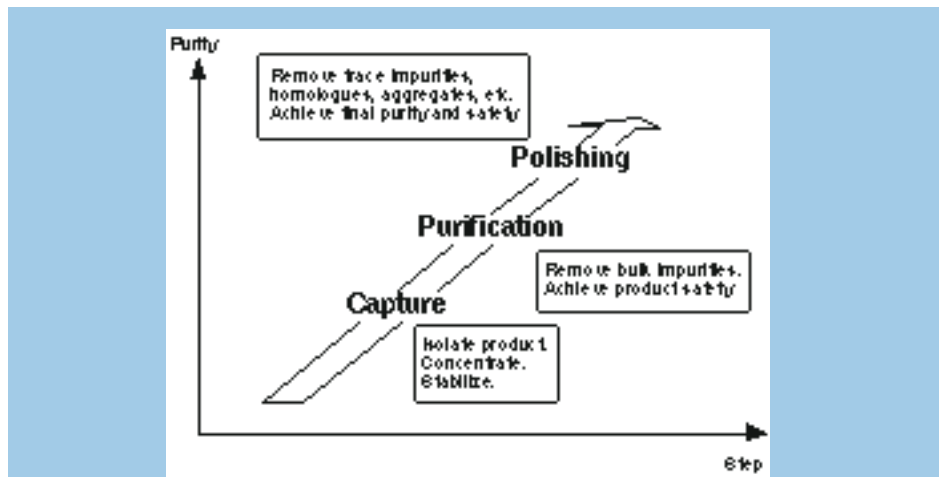

Fig. 61. Different stages in downstream processing

When ion exchange chromatography is applied in **capture**, the purpose will be to adsorb the protein of interest quickly from the crude feed stock and isolate it from critical contaminants such as proteases and glycosidases. The product should be concentrated and transferred to an environment which will conserve potency/acti-

vity. At best, significant removal of other critical contaminants can also be achieved.

In **polishing**, on the other hand, most impurities have already been removed except for trace amounts or closely related substances such as microheterogeneous structural variants of the product. When ion exchange chromatography is applied in such a step the purpose will be to reduce these variants and trace contaminants to a level that will be acceptable for final product quality by applying scaleable high resolution ion exchange chromatography techniques.

When ion exchange chromatography is applied in **intermediate purification**, i.e. steps performed on clarified feed between **capture** and **polishing**, the purpose is to remove most of the significant impurities such as proteins, nucleic acids, endotoxins and viruses down to safe levels.

The strategic focus

In any chromatographic step there are four main performance properties to adjust to reach a fully optimized procedure (Fig. 62), resolution, speed, capacity and recovery.

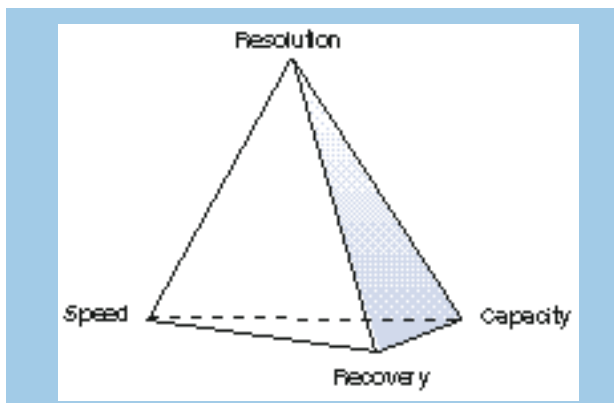

Fig. 62. The optimal process must be defined within the context of competing goals.

In general, optimization of any of these can only be realized at the expense of the others. The relative priority of these parameters will vary depending on whether a particular chromatographic step is for **capture**, **intermediate purification** or **polishing**. This will steer the optimization of the critical processing parameters in any particular step, as well as the selection of the most suitable chromatography matrix to be used in the step.

Capture

In a typical capture situation, throughput (i.e. capacity and speed) will be very important for processing of large sample volumes, keeping the scale of equipment

as small as possible and giving the shortest possible cycle time. Binding capacity for the product in the presence of the impurities will be one of the most critical parameters to reduce the scale of work as much as possible.

High speed may be required to reduce sample application time, particularly if proteolysis or other destructive effects occur. The characteristics of the feed and the anticipated final scale of work will form the basis for the balance between capacity and speed in a capture situation (Fig. 63).

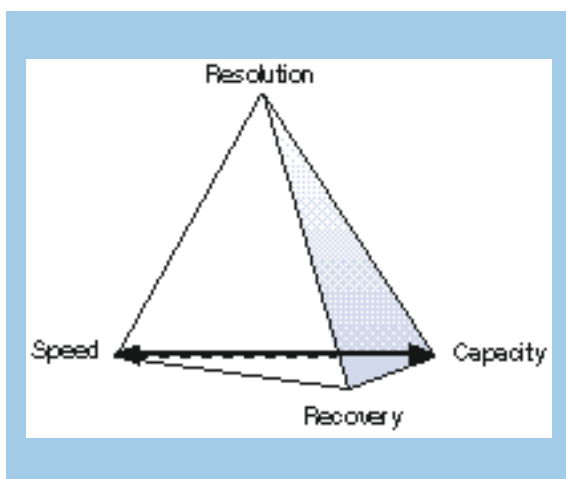

Fig. 63. In a typical capture situation the strategic planning will focus on capacity and speed. If scale of work is the main problem, binding capacity will have higher priority than speed, i.e. it will be more important to utilize the total binding capacity of the bed than to apply very high flow rates during sample application. If time is the main problem, speed will have higher priority than binding capacity, i.e. it will be more important to apply high flow rates, even if this means that a somewhat larger bed volume is needed for processing of a specific amount of feed.

In capture, an important factor impacting capacity is the selectivity during sample adsorption. Typically binding conditions are selected to avoid binding contaminating substances so that more binding sites are available for the protein of interest. This also allows stepwise elution of the product in concentrated form.

Recovery is another parameter that will be of great concern in any preparative situation, especially for production of a high value product. Recovery generally becomes more important further downstream because of the increased value of the purified product. Recovery is influenced by destructive processes in the sample and unfavourable conditions on the column.

Resolution of similar components is not of greatest concern in a typical capture situation. However, there is usually significant resolution and purification from molecules with gross physicochemical difference from the product.

In principle, a capture step is designed to maximize capacity and/or speed at the expense of some resolution. The separation from impurities is usually achieved during binding of the product which can simply be eluted, in concentrated form, by a step.

Intermediate purification

In intermediate purification steps, achieving resolution of similar components will be more and more important further downstream. Capacity will still be important to maintain productivity, i.e. amount of product produced per volume of chromatography media and time unit.

As in a capture step, selectivity during sample adsorption will be important, not only to achieve high binding capacity, but also to contribute to the purification by achieving a degree of separation already during sample application. However, in contrast to a capture step, selectivity during sample desorption from the column becomes important as we go downstream. This is usually achieved by applying a more selective desorption principle, such as a continuous gradient or a multi-step elution procedure.

Hence, the delicate problem in an intermediate purification step will be to decide on the optional balance between capacity and resolution (see Fig. 64). Speed will usually be less critical in a typical intermediate purification step due to the fact that impurities causing proteolysis and other destructive effects should have been removed in the capture step and also due to the fact that sample volume has been reduced at this stage.

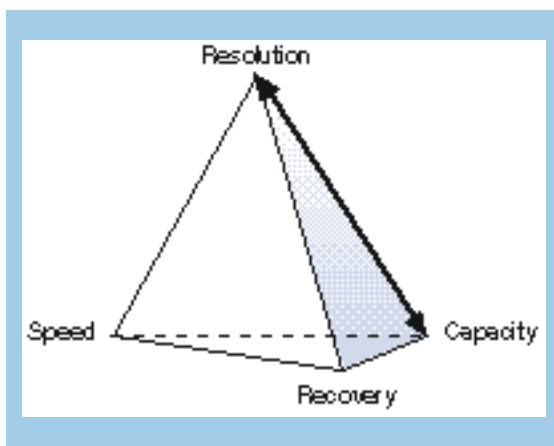

Fig. 64. In a typical intermediate purification situation the strategic planning will focus on resolution and capacity. The requirements for resolution must be defined in context with the nature of the feed and the purity requirements in the final product. Capacity must also be considered to ensure a high productivity. The optimal balance must be defined which then will decide how selectivity parameters should be optimized during sample application to achieve the requirements for resolution (purification) and capacity in the system.

Polishing

In a polishing step the prime issue will be resolution, since this is the last chance to reach the required quality of the product by removal of trace contaminants such as host proteins, structural variants of product, reagents, leachables, endotoxins, nucleic acids and viruses.

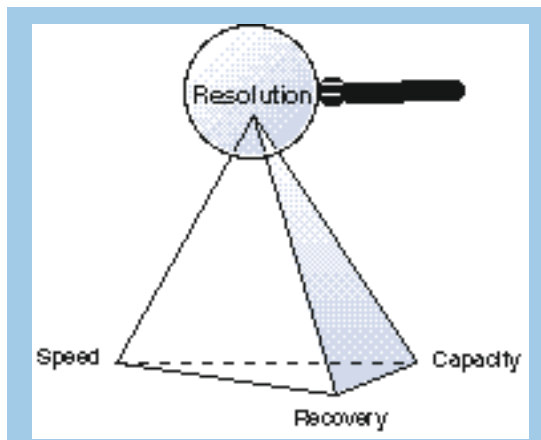

Fig. 65. In a typical polishing situation the strategic planning will focus almost entirely on resolution. However, since more expensive, high resolution media will be used, it will also be important to verify that the high resolution achieved during the scouting experiments at laboratory scale can be maintained also when preparative loadings are applied in the final production scale.

Selectivity during sample desorption from the column will be very important and can be maximized by working on the shape and slope of a continuous gradient elution technique. The resolution required may not be achieved by working on the selectivity alone, but high efficiency media with small bead size usually have to be used in a typical polishing situation (see Fig. 65).

Selection of chromatography media

When chromatography media are to be selected for use in an industrial process there are a number of important selection criteria to take into consideration to assure a safe and smooth transfer from research phase to routine production.

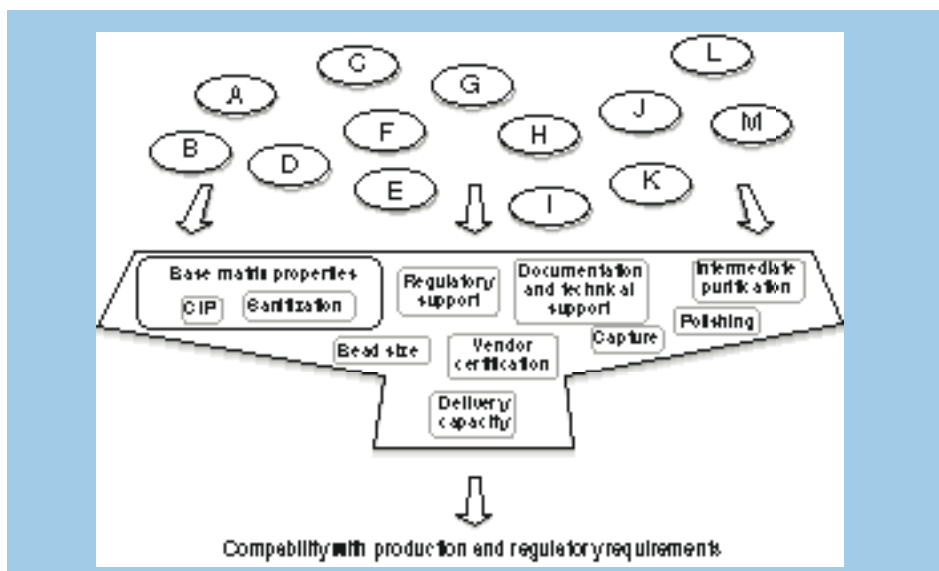

Fig. 66. Pre-selection of separation media.

The number of separation media on the market is quite enormous and it will not be possible to include all different alternatives in the initial media screening. The number of media have to be reduced to cut down time and effort spent on the method scouting phase of process development. Only those media supporting the issues of scalability and suitability for the different stages in a process, listed inside the filter in Figure 66, should be considered for testing.

Base matrix properties and derivitization chemistry

Base matrix properties and derivitization chemistry govern the chemical and physical stability of the chromatography media and are very closely related to the scalability of the complete process. The design in of scalability by selection of suitable media will assure that the media can be packed in large scale columns without change in performance and flow/pressure characteristics and that efficient maintenance procedures can be applied to secure a long media life time. The possibility of any toxic substances leaking from the media into the product stream is also closely related to the properties of the base matrix and the chemistry used for coupling spacers and ligands to the matrix.

Bead size

The particle size and the range of particle size distribution may also have an impact on scalability in the sense that particle size is closely related to the back-pressure generated in the column during a chromatographic run. The optimal bead size in any particular chromatographic step will depend on the characteristics of the feed and the degree of purification required in this step. In a final polishing step, for instance, there will be a need for smaller beads, i.e. high efficiency, to accomplish separation of closely related compounds. In such a step, media with a narrow particle size distribution will help to give a lower back-pressure at a given bed height and flow rate compared to media with a wider particle size distribution.

Documentation and technical support

Comprehensive documentation is required for chromatography media to be used in industrial processes, to facilitate the work with setting up and validating the complete process. Chromatography media used in production processes are treated as raw materials. As with any type of raw material, acceptance criteria have to be established and every new batch of media has to be subjected to tests before it can be brought into production.

Regulatory support

Information on possible extractable compounds and what kind of methods to use to quantify these compounds should be provided by the vendor. Leakage data on the most relevant extractable compounds should be available.

Vendor certification

Vendor certification programmes should be initiated for all vendors of critical chemicals or materials and should certainly include the chromatography media supplier. Such programmes should be implemented to assure a long term, reliable supply of chromatography media of high quality and consistency.

Delivery capacity

The delivery capacity of the vendor is an important issue during the vendor certification phase to secure timely deliveries of large quantities of media when the purification process is scaled up. The largest batch size that the vendor can provide should be discussed and put in relation to the column size that will be used in the final production scale. The stock situation and lead times should be discussed to estimate the consequences for continuity in production in case of an urgent need for a new batch of media.

Long-term contracts, based on forecasts provided by the user, should be discussed to secure future timely deliveries. Long-term delivery guarantees should also be discussed to assure that the same quality of chromatography media can be delivered during the entire life cycle of the product to be purified.

Method design and optimization

The main purpose of optimising a chromatographic step is to reach the pre-defined purity level with highest possible product recovery by choosing the most suitable combination of the critical chromatographic parameters. In process chromatography, in contrast to analytical or small scale preparative chromatography, this also has to be accomplished as quickly, cheaply and easily as possible. The method must be designed carefully to be robust despite variations in feed stock and other conditions in the production hall.

The following sections will give some guidelines for optimising the critical operational parameters which affect the maximum utilization of an ion exchange chromatography step to be used in a production process.

Binding conditions

Selectivity during adsorption to an ion exchanger is optimized by careful selection of pH and ionic strength of the start buffer. A pH far away from the isoelectric point of the molecule of interest will give stronger binding and increased capacity but may also have a negative impact on selectivity due to increased binding of contaminating molecules. If retention of the molecule of interest is low at selected start conditions, due to the pH being very close to the isoelectric point, it will start to elute from the column during sample application (isocratic elution) when the sample volume is increased in a preparative situation. The choice of optimal pH

will always be a balance between selectivity and capacity which in turn depends on the purpose and strategic focus of any particular chromatographic step.

The buffer system should be selected to give maximum buffering power at the least possible ionic strength to ensure high binding capacity of the molecule of interest. To achieve this, the pKa of the buffer should ideally not be more than 0.5 pH units away from the pH being used. Generally, 10 mM of a buffer is the minimum desirable level. Ideally, one of the buffering species should also be uncharged, and so not contribute to the ionic strength. In large scale applications, economic considerations often limit the choice to acetate, citrate, phosphate, or other inexpensive components.

The pH and conductivity in the binding buffer can sometimes cause aggregation/precipitation in the sample when it has been equilibrated to start conditions. If aggregates are formed they may be excluded by the beads and lost in the flow through fraction with loss of recovery as a consequence. The extent of aggregates/precipitate formation depends on the pre-column residence time, after sample has been transferred to start conditions. This problem is often recognized as a scale-up problem since the pre-column residence time may increase considerably upon scale up.

Elution

Elution from ion exchangers is usually accomplished by applying a continuous or stepwise increase of the ionic strength of the eluting buffer, thereby weakening the electrostatic interaction between the bound molecule and the adsorbent.

Depending on the purpose and strategic focus, as previously outlined, different desorption principles can be applied to achieve the objectives of any particular chromatographic step in the most optimal way.

- Stepwise elution
- Gradient elution
- Isocratic elution

Stepwise elution is often preferred in large scale applications since it is technically more simple than elution with continuous gradients. Stepwise elution will also decrease buffer consumption, shorten cycle times and allow the molecule of interest to be eluted in a more concentrated form.

Single-step elution and two-step elution can be characterized as being a "group separation" technique. This type of elution is usually applied in initial chromatographic steps (capture) where the purpose is to remove bulk impurities and substances differing greatly from the product. In a large scale initial chromatographic step, using a crude feed material, media with a large bead size are favoured to avoid problems with high back-pressure and reduced media life time due to high viscosity and severe fouling during sample application. In such an application it will be very difficult, unless the selectivity is extremely high, to resolve closely rela-

ted contaminants from the molecule of interest, even when applying very shallow gradients. The strategy will be to resolve the "group" of substances that the molecule of interest belongs to from "group(s)" containing the contaminating substances. This can most conveniently be achieved by eluting one "group" at a time by applying one or several steps with increasing eluting strength.

In later purification steps however, applying feed material that has been partly purified and using chromatography media with higher resolving power, it will be easier to resolve closely related substances by applying multi-step or gradient elution techniques. Resolution is maximized by working on the shape or slope of a gradient or the eluting strength of different steps in a multi-step procedure. Such eluting techniques can be characterized as being "fine separation" techniques as opposed to the "group separation" referred to above.

In final purification steps (polishing), where the main focus will be to reach the predefined purity of the molecule of interest, resolution is maximized by applying shallow gradients or even isocratic elution using high resolution media with small bead size.

When stepwise elution is applied, one has to keep in mind the danger of getting artefact peaks when a subsequent step is administered too early after a tailing peak. For this reason it is recommended to use continuous gradients in the initial experiments to characterize the sample and its chromatographic behaviour.

Elution by pH gradients is not generally applied. This is because, changing the pH by applying a pH gradient is frustrated by the buffering power of the molecules adsorbed on the column and, in case of weak ion exchangers, the buffering of the adsorbent groups themselves. For stepwise applications, pH elution can be quite successful. The pH change will be delayed compared with the new buffer front because of these titrations, but eventually the bound molecule is desorbed, coincident with a rapid pH change.

Sample load

When the selectivity parameters have been defined to achieve the most optimal balance between resolution, capacity, speed and recovery, in ion exchange chromatography, as for most other adsorption techniques, there are then basically two alternative routes to follow for optimization of sample load and flow rate to achieve highest possible productivity in the system.

I. In a typical capture situation the sample will be applied to the column, non-bound substances will be washed out from the column and the compound of interest will be eluted from the column with a simple step elution procedure. The difference in eluting strength, between the different steps will usually be large, i.e. it will be possible to elute one group of compounds while the others are still retained on the column. In this mode, the entire bed volume can be utilized for sample bin-

ding and the prime consideration when optimising for highest possible productivity is to define the highest possible sample load over the shortest possible sample application time with acceptable loss in yield.

The dynamic binding capacity for the protein of interest should be determined by frontal analysis, i.e. by continuously applying sample on the column up to the point where the compound of interest starts leaking off at the column outlet. PAGE, ELISA or other appropriate techniques are used for the determination of the break-through profile of the compound of interest.

II. In many intermediate purification steps, and always in a polishing step, the requirements for resolution will set the limit for the amount of sample that can be applied to the column. Sample is mainly bound in the upper part of the bed since there will be a need for a certain bed height to achieve separation between closely related substances moving down the column with different velocities in a shallow gradient of elution buffer.

Maximum sample loading is defined by running a series of experiments with gradually increased sample load. Optimal conditions will be the maximum sample load that provides a resolution still high enough to meet the pre-defined purity requirements.

Flow rate

The maximum flow rate that can be applied in any particular ion exchange chromatography step will differ between different parts of the chromatographic cycle.

Since low molecular weight substances show high diffusion rates, i.e. are transported rapidly between the mobile phase and stationary phase, the flow rate during equilibration, washing and regeneration procedures is limited primarily by the rigidity of the chromatography media and by system constraints regarding pressure specification. Larger molecules, i.e. the substances to be separated during the chromatographic run, show a lower diffusion rate which will limit the flow rate that can be applied during sample adsorption and desorption.

In a typical capture situation, the flow rate during sample application has to be controlled so that the residence time in the column allows for a complete binding without leakage in the flow through fraction. Maximum flow rate is defined by running the frontal analysis test (break-through) referred to above at a number of different flow rates. Optimal conditions will depend on the requirements for speed and capacity in the system. If speed, i.e. sample application time, is critical due to proteolysis or other detrimental effects in the feed material, a higher flow rate may have to be used on the expense of the binding capacity in terms of amount of sample that can be applied per volume of media. If speed is not a big issue, binding capacity can be increased on the expense of flow rate which will reduce the scale of work in the final production process. Occasionally, high back-pressure, due to

the viscosity and crude nature of the feed, may set the limit for maximum flow rate during sample application.

During elution, the flow rate will affect resolution between compounds to be separated and also the concentration of these compounds in the product pool. When there is a need for high concentration in the product pool, a lower flow rate may have to be applied to minimise the volume (dilution) of the eluted product/fractions. This is particularly important in a step preceding a gel filtration step, where the sample volume is limiting for loading capacity.

Selecting a column

When a chromatographic step is being developed to be a part of a manufacturing process and the time has come for scaling up, the next crucial step in ensuring a reliable product quality and maximum production economy is the decision about which column to use. Information on large scale columns from Pharmacia Biotech is available upon request. Different demands are put on a column for production compared with one used for the initial laboratory scale and scale-up experiments. Flexibility, which is needed in laboratory scale and scale-up is achieved by using a column with a movable adaptor. In production, consistency in performance and safety of the end product are the main concerns. Here the column packing has to be reproducible, materials of construction have to be well characterized for leakage and the design mechanically stable.

A number of criteria have to be considered. These criteria are more dependent on the scale of operation than on the media and are thus very similar in their importance for ion exchange, hydrophobic interaction, gel filtration and affinity chromatography. Their ranking and importance change when moving through a chromatographic process is shown in Figure 67.

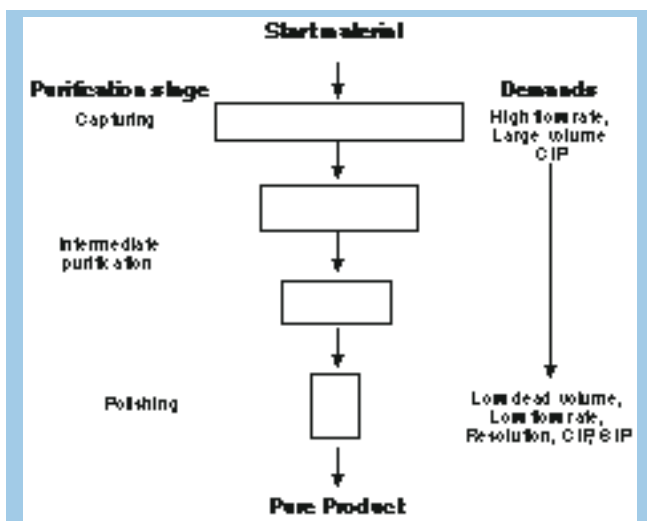

Fig. 67. In the initial capturing, handling large volumes at high flow rates is important. When moving towards the final steps, the demand for low dead volume columns and systems to achieve high resolution becomes more and more important.

Aspects of column design

Flow distribution system

The most important factor in process column construction is to design the flow distribution system to give as even a flow distribution as possible at the column inlet and outlet. The aim is to retain HETP values of the same order as in the laboratory column. This is usually achieved by a construction where the radial back-pressure is negligible compared to the axial back-pressure at the column inlet, see Figure 68. The simplest method is to place a coarse mesh net between the column end piece and the finer mesh net retaining the bed, to create channels for radial distribution. This may be combined with multiple inlet/outlet ports depending on column diameter. Depth filters are more easily clogged due to the relatively large filter surface. This may be a severe disadvantage in continuous operation.

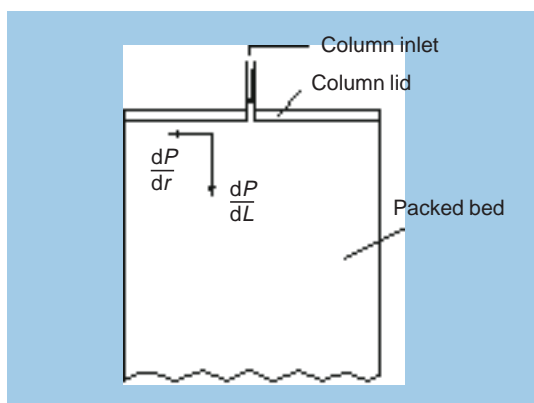

Fig. 68. Radial and axial back-pressure in a column distribution system.

Material resistance and durability

Wetted components must be constructed from materials with high chemical resistance against the harsh chemicals which are frequently used for cleaning-in-place (CIP) and sanitization procedures such as 1 M NaOH, salts, acids, etc.

Stainless steel of high grades is most commonly used for very large columns.

However, stainless steel does not always have sufficient corrosion resistance when high salt concentrations in acidic solution are used. In this case fluoroplastic coated stainless steel is recommended. Materials should be chosen to minimize leakage and be tested for toxicity.

Sanitary design

Effective cleaning and sanitizing of packed columns depends on the total column design, including the absence of threaded fittings and the smoothness of wetted surfaces. It is important to minimize dead volumes in the column to hinder bacterial attachment and facilitate cleaning. Columns constructed from calibrated borosilicate glass allow the use of thin O-rings in the adaptor and end piece and

give minimum dead volumes. Borosilicate also has a smooth and durable surface which facilitates cleaning. Plastic columns are usually less expensive but most plastics do not meet pharmaceutical industry demands for chemical resistance, hygienic design and in-line cleaning. They may however be well suited for scale-up experiments.

Pressure vessel safety

Large scale columns should be regarded as pressure vessels even if the actual working pressures usually are kept low. Large volumes of organic solvents may be handled during cleaning which calls for explosion proof equipment. The column design has to meet local regulations to be approved.

Regulatory support

Regulatory support for process scale columns should be available from the column supplier to provide information on materials necessary for registration of the process including chemical stability, toxicological tests, physical data and column construction.

Ergonomics

For easy handling of process columns it is important that they are constructed in a stable way and are easy to pack and clean. Large columns should preferably have lockable wheels.

In laboratory columns, the bed height can easily be adjusted using moveable adaptors. In large columns, adaptors may be impractical and too heavy to handle. Therefore, columns with fixed end pieces are selected in many applications.

Valves should be easy to reach and remove when the column is taken apart.

Packing large scale columns

Column configuration

Process columns with a moveable adaptor are essentially packed in the same way as laboratory columns with adaptors. In essence, this means that the gel slurry is compressed by a flowing liquid until the bed height has stabilized, at which point the flow is stopped and the adaptor is lowered onto the gel surface and secured in place.

Large scale columns are, however, frequently supplied with fixed end pieces. This calls for a different packing technique. An extension tube is fitted on top of the column as a reservoir for the gel slurry. When the bed has been packed and settled at the join between the extension tube and the column, the extension tube is removed and the top column lid is secured in place. With this method it is important to

calculate the exact amount of media that is required to get the appropriate bed height.

Packing the column

Detailed packing instructions for ion exchange media in process columns will not be given here. Please refer to the instructions supplied with respective media and respective column.

Scale-up

When the IEX step has been optimized at laboratory scale, the method can be scaled-up. Provided that scalability has been "designed-in" during the development phase, scale-up to final production scale should be straightforward.

"Design-in" of scalability has to do with how the chromatographic step has been designed and optimized (robustness, simplicity, costs, capacity etc.) and the choice of appropriate chromatography media (chemical stability, physical stability, bead size, cost etc.).

Some general guidelines for scaling up are outlined in Table 23.

Table 23. Scale-up guidelines.

Maintain	Increase	Check system factors
Bed height	Column diameter	Distribution system
Linear flow rate	Volumetric flow rate	Wall effects
Sample concentration Gradient volume/bed volume	Sample load	Extra column zone spreading

Increasing the bed volume by increasing the column diameter and increasing volumetric flow and sample load accordingly, will ensure the same cycle time as in the laboratory scale method development. The column bed height, linear flow rate, sample concentration and ratio of sample to gel, all optimized at laboratory scale, will be kept the same. If a gradient is used for elution, the ratio of gradient volume to bed volume will remain constant and, therefore, the time required for the gradient to develop and the effect on resolution, will remain the same on the larger column. The same principle is applied for the volume of each step in a step elution procedure.

Different system factors may affect performance after scale-up. If the large scale column has a less efficient flow distribution system, or the large scale system introduces large dead volumes, peak broadening may occur. This will cause extra dilution of the product fraction or even loss of resolution if the application is sensitive to variations in efficiency (plate number) in the system used.

scaling up to a larger diameter column means that most of the bed support generated by the friction against the column wall is lost. This can give increased bed compression and poorer flow/pressure characteristics.

If all the above aspects are taken into consideration, chromatographic variability is normally not a major issue when scaling up.

Non-chromatographic factors may have a more significant effect on performance during scaling up. These factors include: changes in sample composition and concentration that often occur as the fermentation scale increases, precipitation in the feed stock due to longer holding times when large volumes are handled, non-reproducibility of the buffer quality due to inadequate equipment for consistently preparing large quantities of buffer solutions, and microbial growth in feed-stock or buffers due to increased handling and longer holding times.

Figure 69 shows a 700-fold scale up of a model protein separation on SOURCE 30S going from a 2.2 ml column to a 1.57 liter column in one step.

Column: SOURCE 30S, a) 7.5 mm i.d. x 50 mm (2.2 ml)
 b) 200 mm i.d. x 50 mm (1.57 l)
Sample: Mixture of chymotrypsinogen, cytochrome C and lysozyme
Sample load: 0.32 mg/ml bed volume
Eluent A: 20 mM sodium phosphate, pH 6.8
Eluent B: 20 mM sodium phosphate + 0.5 M NaCl, pH 6.8
Flow rate: 300 cm/h ; a) 2.2 ml/min b) 1.57 l/min
Gradient: 0-100% B; 20 column volumes
System: a) FPLC System
 b) BioProcess Engineering System

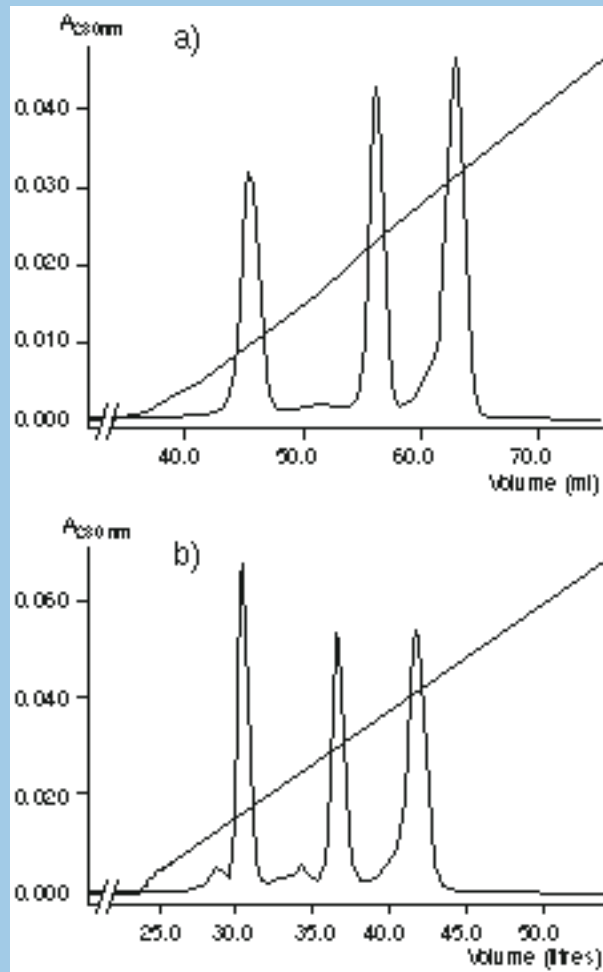

Fig 69. 700-fold scale up from a 2.2 ml lab-scale column to a 1.57 litre production scale FineLINE 200 column. (Work by Pharmacia Biotech, Uppsala, Sweden.)

12. Applications

Ion exchange has proven to be one of the major methods of fractionation of labile biological substances. From the introduction of the technique in the 1960s to the development of modern high performance media, ion exchange chromatography has played a major role in the separation and purification of biomolecules and contributed significantly to our understanding of biological processes. The examples given in the following section have been drawn from the published literature as well as from work in our own laboratories.

For detailed information on specific subjects the reader is referred to the original work.

The design of a biochemical separation

Ion exchange chromatography, in common with other separation techniques in the life sciences, is rarely sufficient as the sole purification stage in the separation or analysis of complex biological samples. Ion exchange is frequently combined with other techniques which separate according to other parameters such as size (gel filtration), hydrophobicity (hydrophobic interaction chromatography or RPC) or biological activity (affinity chromatography).

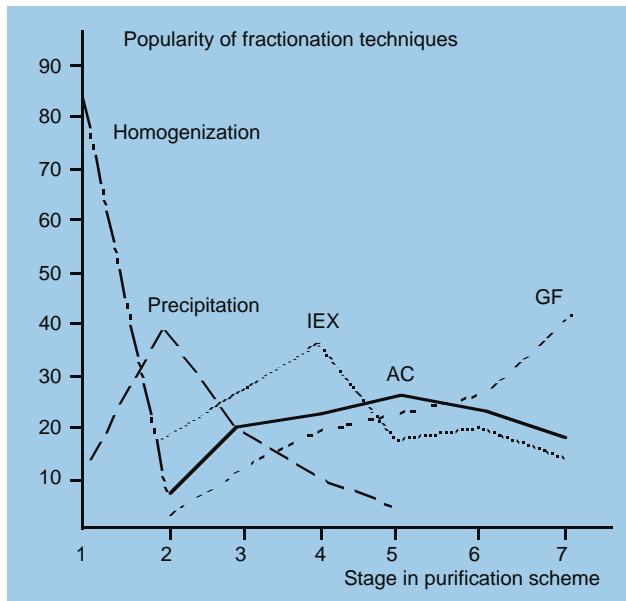

Fig. 70. Frequency of use of fractionation techniques (1). (Reproduced by kind permission of the authors and publisher.)

Not only is the choice of techniques important. The order in which they are employed will also play a role in determining the speed, the convenience and the overall yield for the purification.

Sample loading, sample dilution and impurity contamination are usually maximal at the beginning of a separation scheme. At this stage the high capacity, high selectivity and concentrating effect of ion exchange makes the technique ideal.

This suitability is reflected in Figure 70 which shows the frequency of use of different fractionation techniques in published protein purification schemes (1).

The use of multi-dimensional chromatography with ion exchange as a first step is well illustrated by the separation of monoclonal IgG_{2b} from cell culture medium (Fig. 71). An initial purification and concentration of the antibody from 500 ml cell culture medium by cation exchange chromatography on SP Sepharose High Performance was followed by a second fractionation by gel filtration using Superdex 200 prep grade.

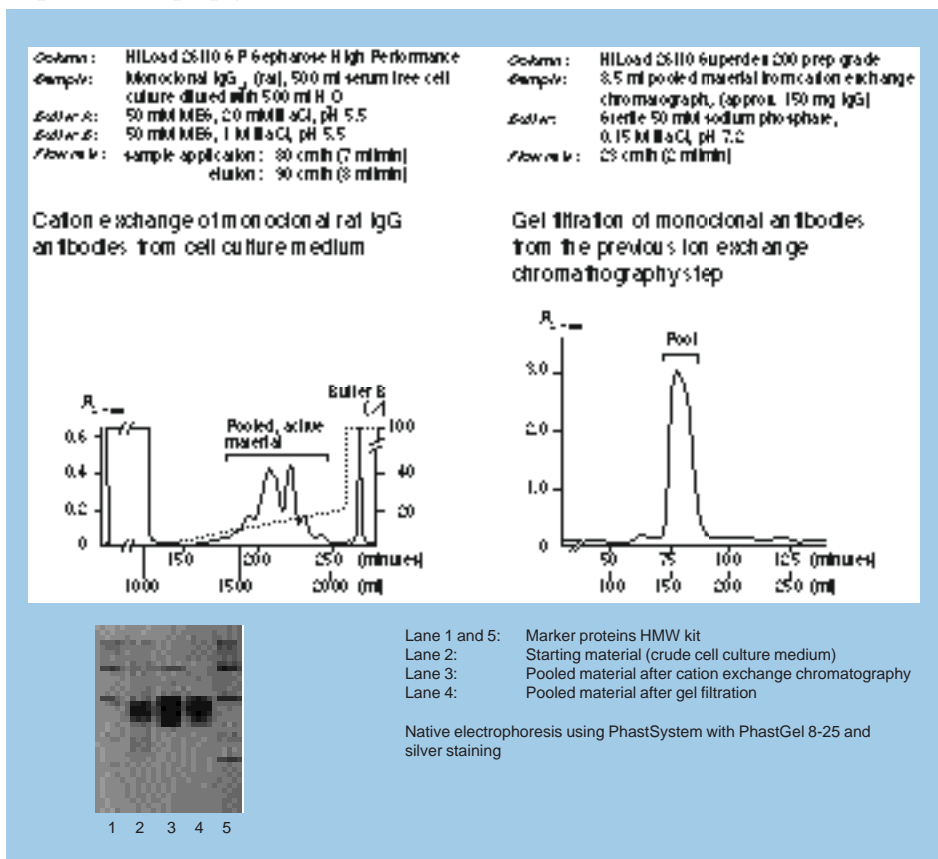

Fig. 71. Purification of rat monoclonal IgG_{2b} from cell culture supernatant. (Work by Pharmacia Biotech, Uppsala, Sweden).

The sample composition with regards to ionic strength and pH should be taken into consideration when designing the separation scheme. In ion exchange chro-

matography solutes bind to the gel at low ionic strength and are eluted from the column at a higher ionic strength. The converse situation occurs in hydrophobic interaction chromatography. Thus if these two techniques are to be used in a separation scheme it is logical to have them adjacent to each other. This principle is illustrated in Figure 72 which shows the purification of human α_2 -macroglobulin from Cohn Fraction III.

After initial purification by affinity chromatography on Blue Sepharose CL-6B to remove albumin, the sample was applied to a Q Sepharose High Performance column and eluted with an increasing salt concentration gradient. Relevant fractions were then pooled and α_2 -macroglobulin was purified to homogeneity by hydrophobic interaction chromatography on a Phenyl Sepharose High Performance column.

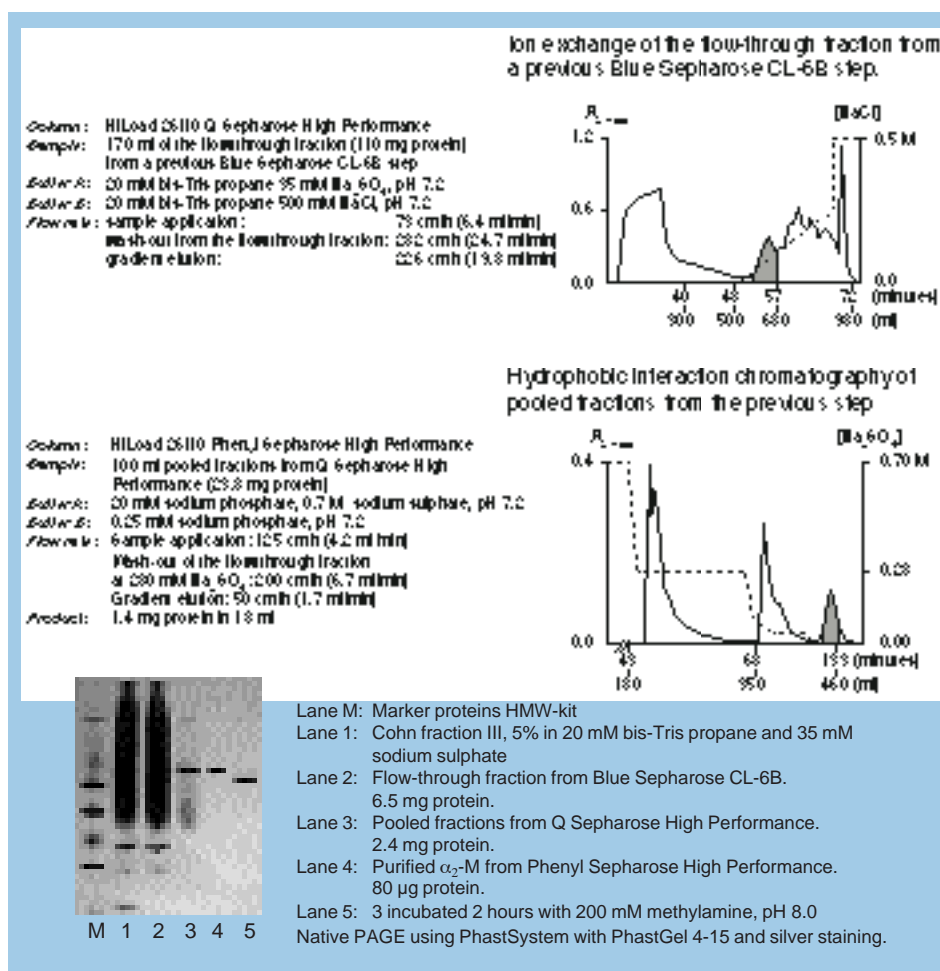

Fig. 72. Purification of human α_2 -macroglobulin. (Work by Pharmacia Biotech, Uppsala, Sweden.)

Towards the end of a separation scheme the complexity and the volume of sample to be handled is smaller, but in most cases the need for higher resolution is increased. Ion exchange chromatography, particularly with MonoBeads, SOURCE, or Sepharose High Performance media can also be used at this stage (Fig. 73).

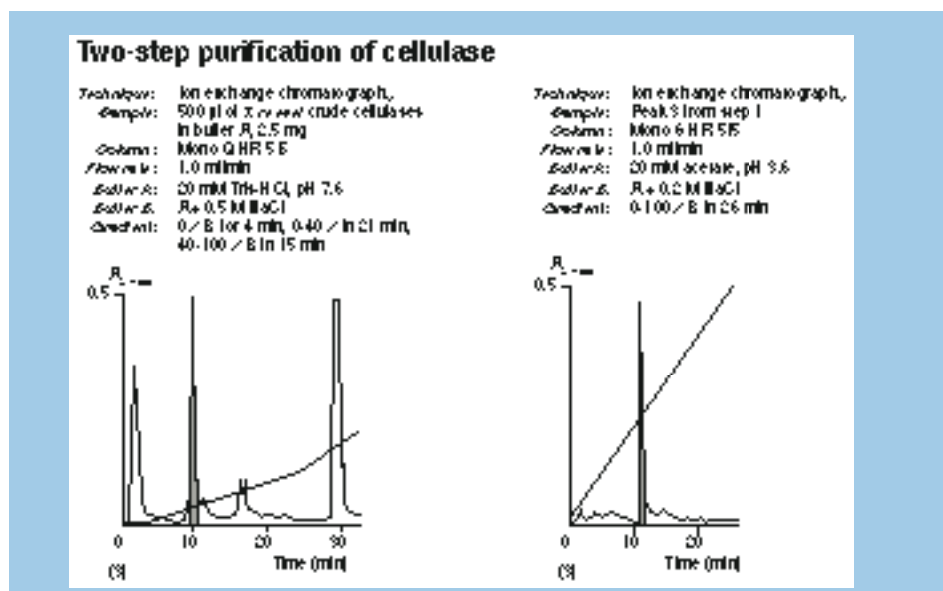

Fig. 73. Use of ion exchange in the final purification of cellulase. (Work by Pharmacia Biotech, Uppsala, Sweden.)

Application examples

Ion exchange chromatography has been used successfully to separate all classes of charged biological molecules. The following are some representative examples.

Enzymes

In the purification of biologically active proteins such as enzymes the recovery of biological activity is usually as important as the recovery of protein mass or degree of homogeneity. Ion exchange chromatography has played a role in the purification of thousands of enzymes, and using modern matrices with optimized separation conditions gives extremely high recoveries. This is exemplified by the separation of enzymes from chicken breast muscle on Mono Q (Fig. 74). The recovery of creatine kinase in this separation was 89%.

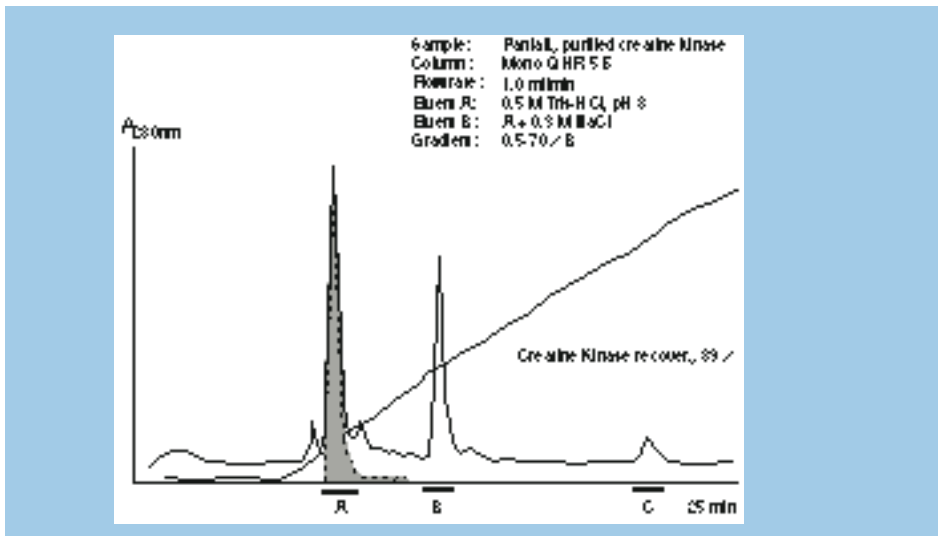
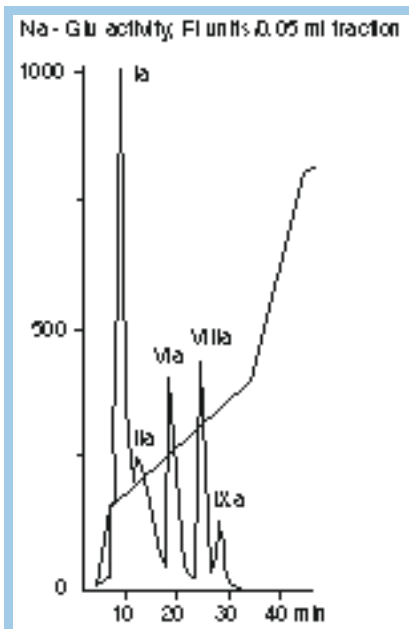

Fig. 74. Separation of creatine kinase from a partially purified preparation of chicken breast muscle on Mono Q. (Work by Pharmacia Biotech, Uppsala, Sweden.)

Isoenzymes

Normally the isoforms of an enzyme have approximately the same molecular weight. This makes their separation impossible by gel filtration. However, the small differences in charge properties resulting from altered amino acid composition enable the separation of isoenzymes using ion exchange chromatography.



N-Acetyl β -D-glucosaminidases have been widely investigated in the diagnosis of haematological malignancies. In the case of common acute lymphoblastic leukaemia, an isoenzyme, referred to as “Intermediate 1 Form” has been reported (29). Using high resolution ion exchange chromatography (Fig. 75) this previously “single” peak has been resolved into a number of component isoenzymes which had previously only been detectable using isoelectric focusing.

Fig. 75. Separation of Leukaemic cell N-Acetyl β -D-glucosaminidase isoenzymes by anion exchange chromatography on Mono Q. NA-Glu activities associated with distinct peaks (Ia-IXa) are indicated in relation to the NaCl gradients (29). (Reproduced by kind permission of the authors and publisher.)

Immunoglobulins

Ion exchange is frequently used for the purification of immunoglobulins. Figure 71 shows the purification of rat monoclonal IgG_{2b} from cell culture supernatant. As illustrated in Figure 76 the technique can also be applied to the purification of monoclonal immunoglobulin from ascites fluid.

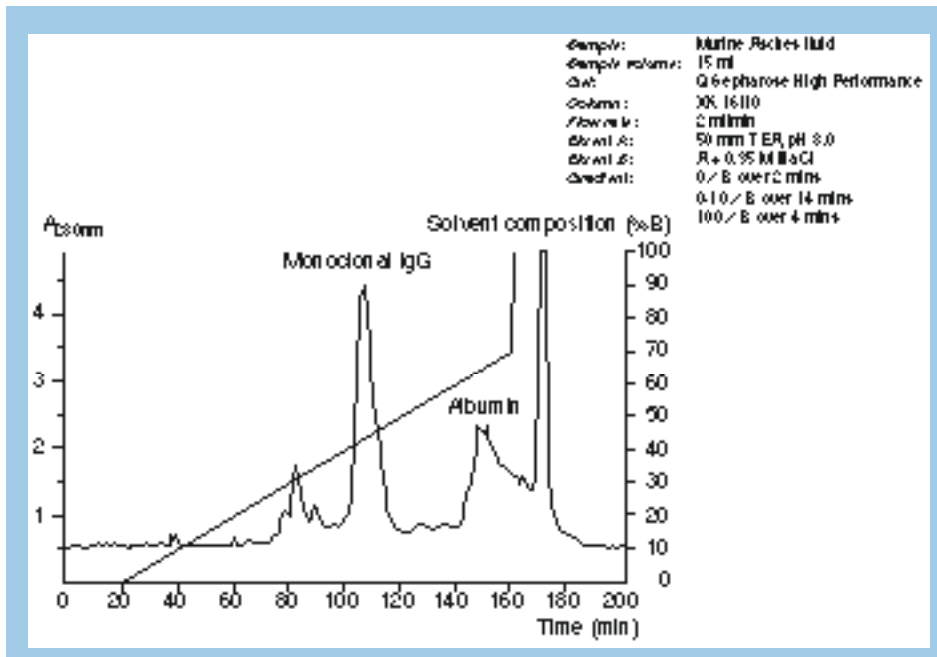

Fig. 76. Ion exchange purification of mouse monoclonal IgG₁ from ascites fluid. (Reproduced by kind permission of Dr. LeRoy Baker, Eli Research Laboratories, Eli Lilly and Company, Indianapolis, USA.)

Nucleic acid separation

Nucleic acids, being charged molecules, can also be fractionated and purified using ion exchange chromatography. A recent application of the technique in this area is the purification of plasmids from bacterial cultures. This process is traditionally done by centrifugation using CsCl gradients. Figure 77 shows the separation of plasmid HB101 (pBR322) by anion exchange chromatography on Q Sepharose High Performance. Subsequent analysis showed the electrophoretic purity of the plasmid to be equivalent to that obtained by centrifugation, as was its behaviour in ligation and transformation assays. The time, however, required for the preparation was 1 hour using the chromatographic method and approximately 8 hours using centrifugation.

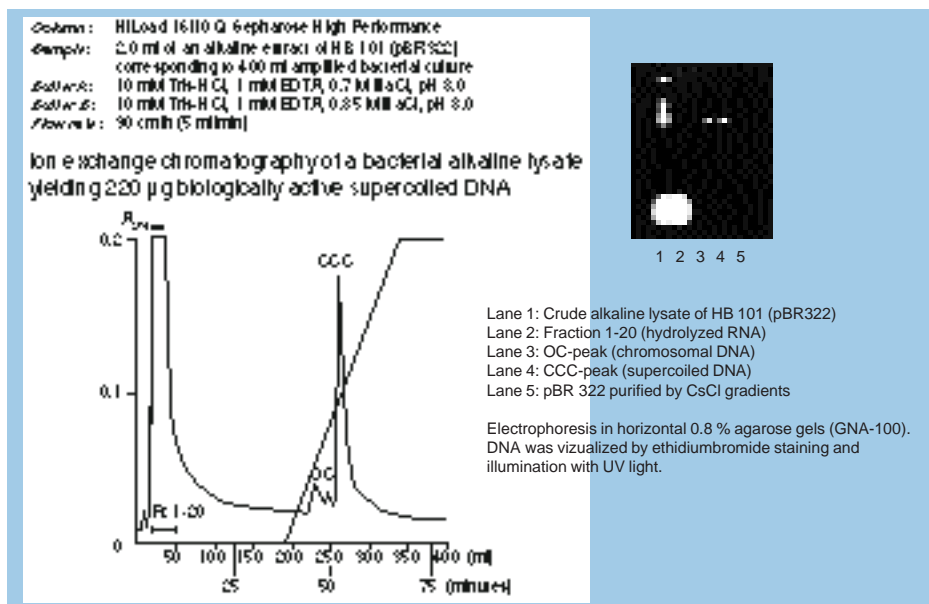

Fig. 77. Ion exchange purification of plasmid DNA. (Work by Pharmacia Biotech, Uppsala, Sweden.)

Polypeptides and polynucleotides

Ion exchange chromatography is not limited in its application to macromolecules such as proteins and nucleic acids. The technique can be used in the separation of peptides as illustrated by the separation of cyanogen bromide fragments of collagen (Fig. 78).

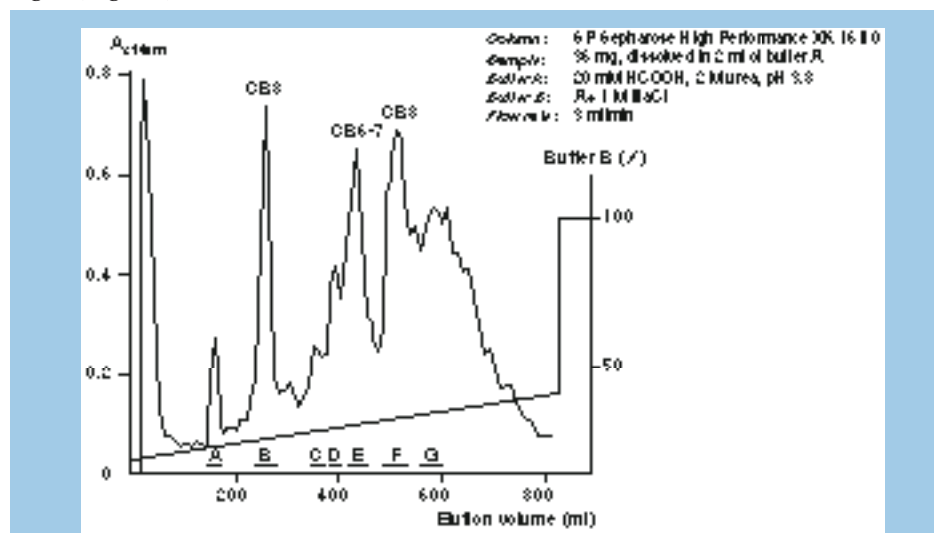

Fig. 78. Separation of CNBr-peptides from α -1 chains of collagen type 1. (Work by Pharmacia Biotech, Uppsala, Sweden.)

In peptide mapping applications ion exchange chromatography can be used advantageously as a complement to reverse phase chromatography since both offer high resolution but separate according to different parameters (30).

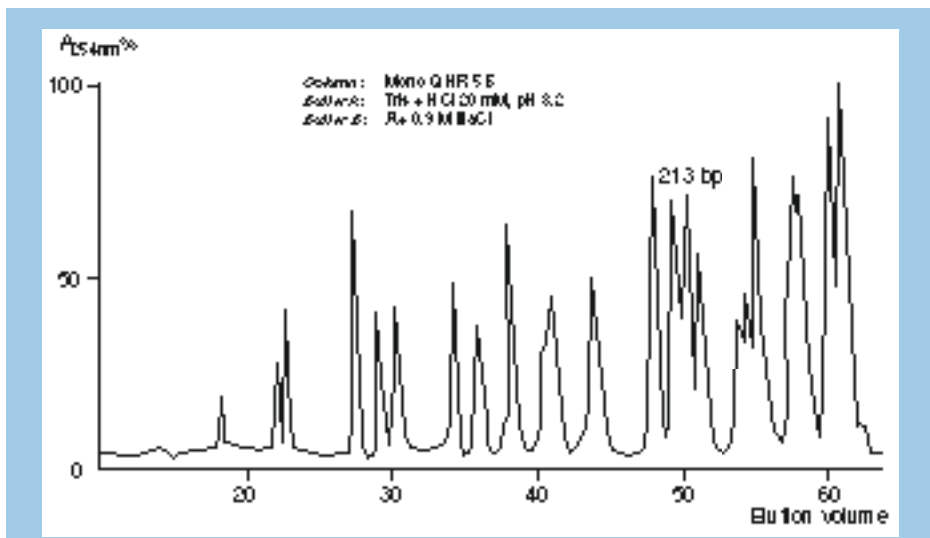

Fig. 79. Ion exchange separation of DNA restriction fragments from pBR322 cleaved by HaeIII (31). (Reproduced by kind permission of the authors and publishers.)

Analogously, ion exchange can be used to separate oligonucleotides such as restriction fragments of DNA (31) (Fig. 79) and even individual nucleotides (32, 33, 34) (Fig. 80).

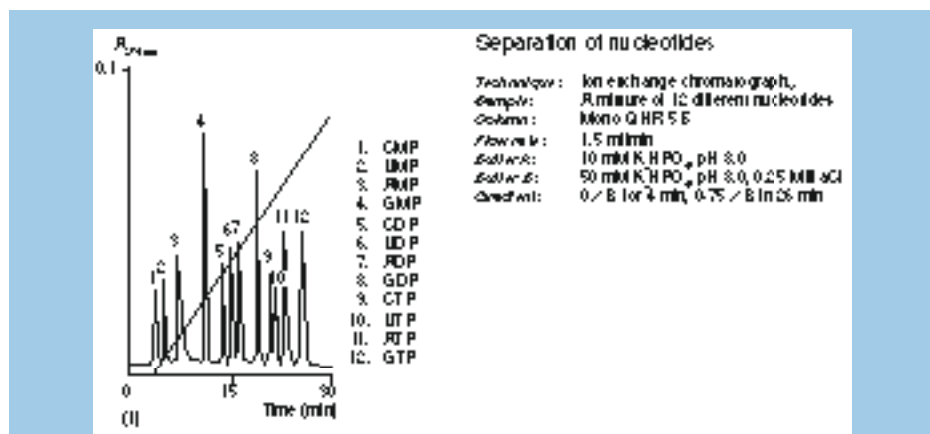

Fig. 80. Ion exchange separation of nucleotides. (Work by Pharmacia Biotech, Uppsala, Sweden.)

Antisense phosphorothioate oligonucleotides

Phosphorothioate analogs of DNA have been identified as promising candidates for oligonucleotide therapy, a major advantage being their in-vivo resistance to degradation by nucleases.

Technology for automated gram-scale synthesis of phosphorothioate DNA oligomers has developed rapidly in recent years. In contrast, the large scale purification technology for therapeutic or diagnostic oligonucleotides has received little attention, and has largely been based on scaling up methods suitable for analysis or research.

In this application example, a novel method* for purifying synthetic phosphorothioate oligonucleotides in large scale using SOURCE 30Q is shown. The method includes adsorption of trityl-on oligonucleotide on SOURCE 30Q, washing with 10 mM NaOH and 2 M sodium chloride to remove non-tritylated failure sequences, on-column cleavage of the trityl groups using 0.4% trifluoroacetic acid, washing with 10 mM NaOH and eluting the oligonucleotide with a sodium chloride gradient to further purify it from shorter sequences. After elution, SOURCE 30Q is regenerated with 30% isopropanol in 2 M sodium chloride to wash away the adsorbed trityl-groups.

A 25-mer phosphorothioate oligonucleotide produced on OligoPilot II DNA/RNA Synthesizer was purified with this method. A 25% ammonia solution containing the crude oligonucleotide mixture obtained after synthesis was applied directly onto a 0.8 liter SOURCE 30Q column. The chromatogram from the gradient elution is shown in Figure 81. Analysis of the pool revealed a yield of 1.56 g product with a purity of 97% as determined by capillary electrophoresis, see Fig 82. The overall recovery was approximately 70%. The complete process (cleavage and purification) took less than three hours.

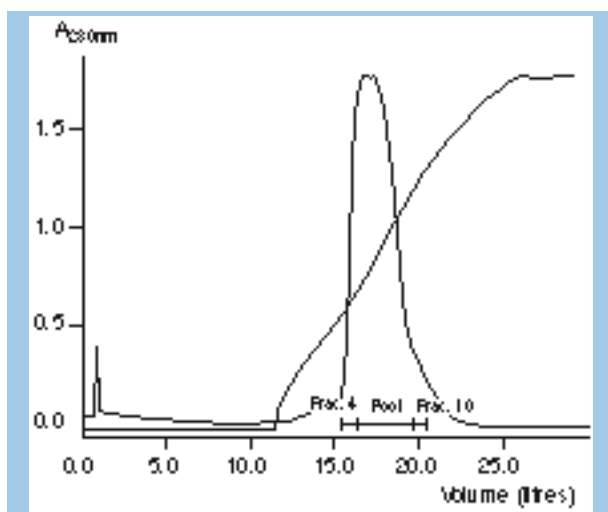

Fig. 81. Preparative purification of 25-mer phosphorothioate oligonucleotide on SOURCE 30Q. (Work by Pharmacia Biotech, Uppsala, Sweden.)

*patent pending

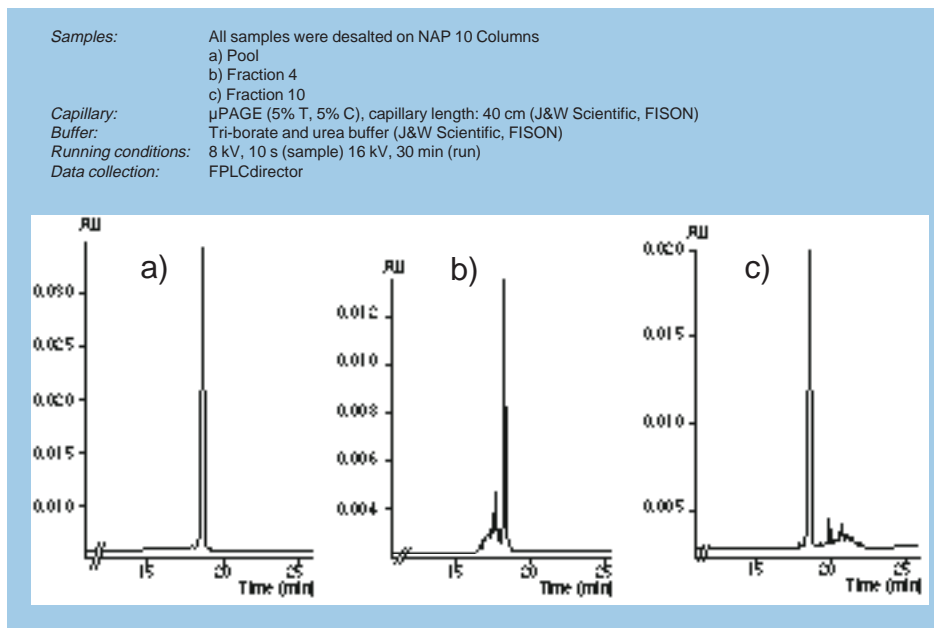

Fig. 82. Capillary electrophoresis of the pool and side fractions from the preparative purification of 25-mer phosphorothioate oligonucleotide shown in Fig. 81. (Work by Pharmacia Biotech, Uppsala, Sweden.)

Areas of application

In the preceding chapters the examples which have been used to illustrate the principles and practice of ion exchange chromatography have mostly been based on analytical and preparative applications from the research laboratory.

Ion exchange chromatography also has many important applications in the field of industrial and pilot scale preparations. Many blood products such as albumin and IgG (35) as well as the products of recombinant DNA technology, such as growth factors and pharmaceutically important enzymes (Fig. 83), are purified using this technique.

An example of a pilot scale purification of a recombinant protein using ion exchange chromatography is given at the end of this chapter. For further information on the application of ion exchange chromatography at pilot and process scales the reader is advised to contact Pharmacia Biotech.

Analytical applications of ion exchange chromatography are to be found in diverse areas such as quality control of purified products or process monitoring in biotechnology. Figure 84 shows the use of cation exchange in monitoring a fermentation process for the production of β -galactosidase.

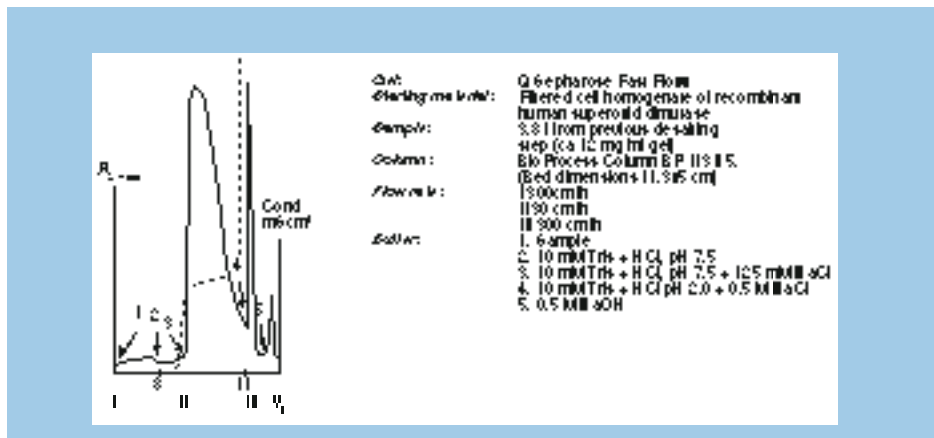

Fig. 83. Process scale purification of recombinant superoxide dismutase by ion exchange chromatography on Q Sepharose Fast Flow. (Work by Pharmacia Biotech, Uppsala, Sweden.

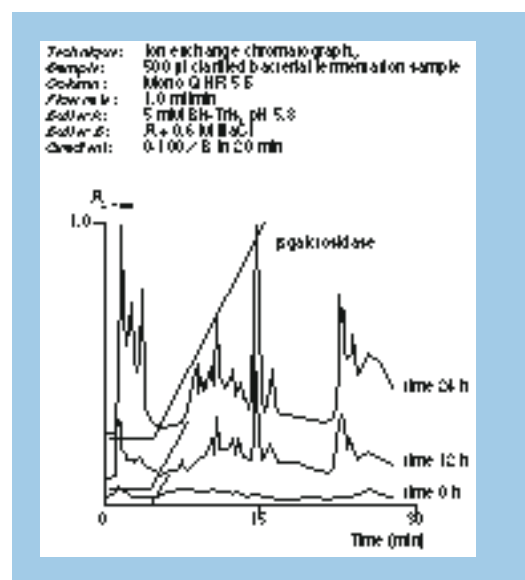

Fig. 84. Monitoring the production of β -galactosidase (36).

Other areas of application include food research where FPLC ion exchange can be used in the study of wheat varieties (Fig. 85) and in clinical research where ion exchange chromatography has been used in studies such as the relationship between post-partum depression and β -endorphin secretion (Fig. 86) and the correlation of proteinuria with different renal conditions (Fig. 87).

A chromatogram of the urine from patients exhibiting tubular proteinuria, due to acute pyelonephritis, severe burns or renal transplants, shows distinct peaks corresponding to β_2 -microglobulin, retinol binding protein and α_1 -acid glycoprotein. The disappearance of these peaks could be correlated with the reversal of their causal lesion (39).

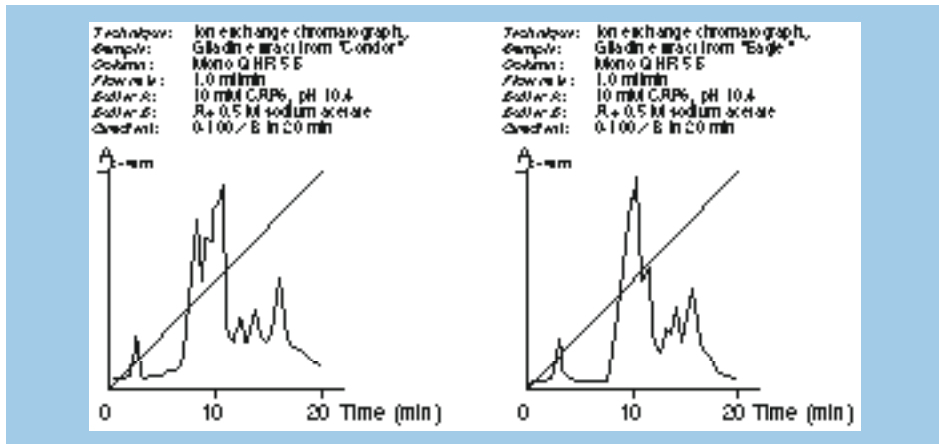

Fig. 85. Protein profiles of wheat varietal gliadins (37).

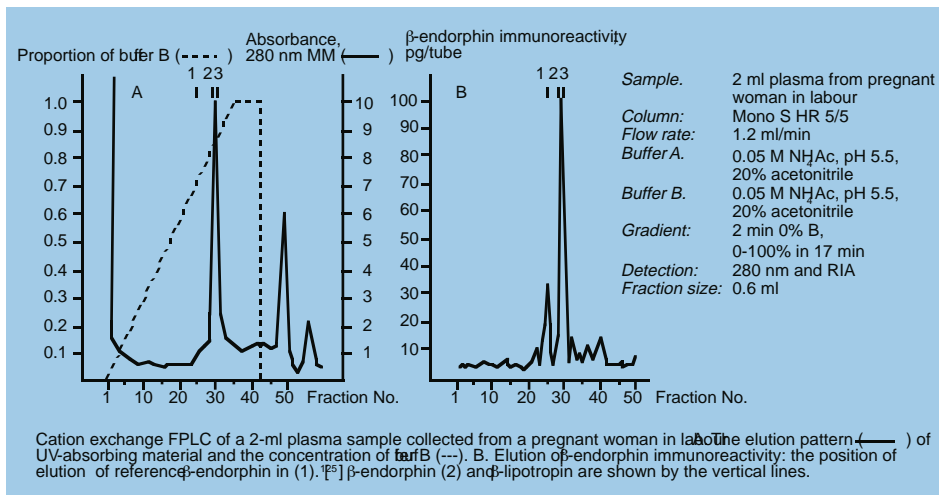

Fig. 86. Cation exchange of chromatography by plasma β -endorphin (38).

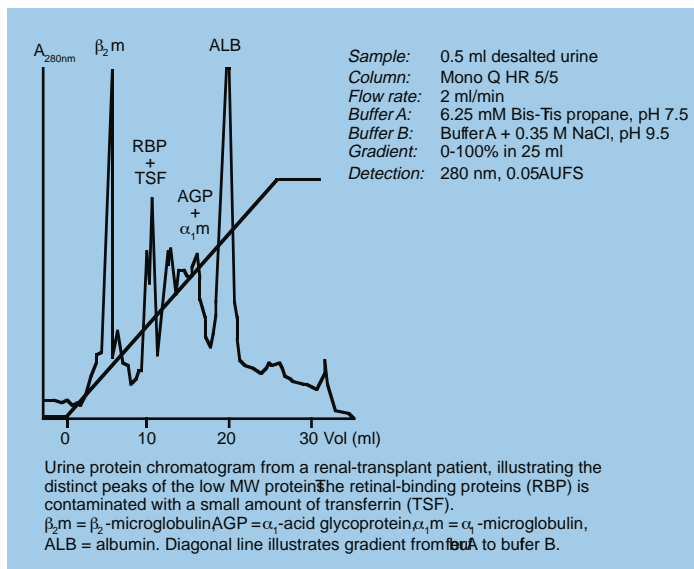

Fig. 87. Anion exchange of urine in renal proteinuria (39).

Purification of a recombinant

Pseudomonas aeruginosa exotoxin A, PE553D

This application shows a purification process for a genetically modified recombinant *Pseudomonas aeruginosa* exotoxin A (MW 55 000) expressed in the periplasm of *E. coli*. The process was developed for large scale production of modified toxin, conjugation to a polysaccharide and use as a vaccine. The purification strategy used chromatography media differentiated to tackle the problems of capture, intermediate purification and polishing (for further information please refer to Chapter 11.)

The result was a highly purified exotoxin A from crude cell homogenate using only four chromatography steps, and taking less than half the time of a more conventional approach.

Exotoxin A was captured directly from unclarified *E. coli* homogenate by expanded bed adsorption using STREAMLINE DEAE adsorbent in a STREAMLINE 200 column (Fig. 88). The following intermediate purification step was hydrophobic interaction chromatography (HIC) on Phenyl Sepharose 6 Fast Flow (high sub) packed in a BPG 200 column (Fig. 89). This step removed a substantial part of the UV absorbing material (including nucleic acids) that could interfere with the following steps. The second intermediate purification step on SOURCE 30Q, packed in FineLINE 100 column, removed the majority of the remaining contaminants (Fig. 90). The polishing step was HIC on SOURCE 15PHE (Fig 91). The process resulted in a pure protein, according to PAGE and RPC analysis (Fig 92 and 93), and the overall recovery was 51 % (Table 24).

Column: STREAMLINE 200 (i.d. 200 mm)
Medium: STREAMLINE DEAE, 4.7 l
Sample: 4.7 kg of cells were subjected to osmotic shock and suspended in a final volume of 180 litres 50 mM Tris buffer, pH 7.4 before application onto the expanded bed.
Buffer A: 50 mM Tris buffer, pH 7.4
Buffer B: 50 mM Tris, 0.5 M sodium chloride, pH 7.4
Flow rate: 400 cm/h during sample application and wash
 100 cm/h during elution
System: BioProcess Modular

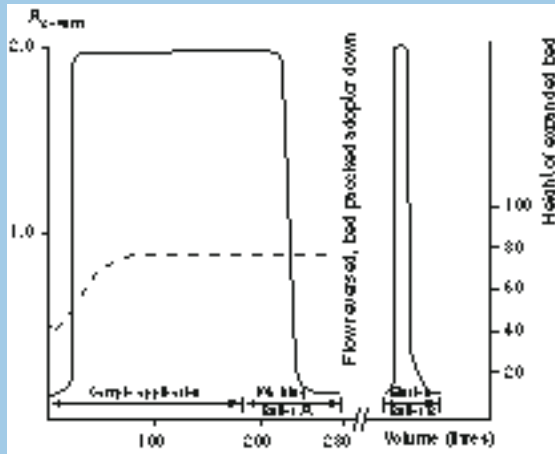

Fig. 88. Capture by expanded bed adsorption on STREAMLINE DEAE.

Column: BPG 200/500 (i.d. 200 mm)
Medium: Phenyl Sepharose 6 Fast Flow (high sub), 4.7 L (150 mm bed height)
Sample: 4.5 L of the previous pool were adjusted to 0.6 M ammonium sulphate and applied onto the column
A: 50 mM phosphate, 0.7 M ammonium sulphate, pH 7.4
B: 20 mM phosphate, pH 7.4
C: Distilled water
Flow rate: 120 cm/h

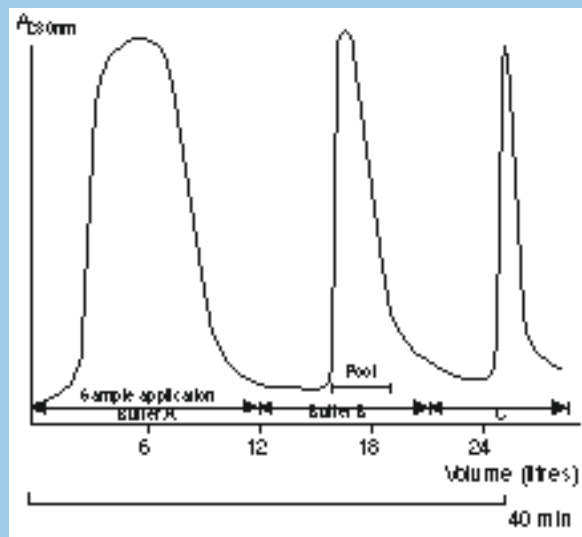

Fig. 89. Intermediate purification by hydrophobic interaction chromatography on Phenyl Sepharose 6 Fast Flow (high sub).

Column: FineLINE 100 (i.d. 100 mm)
 Medium: SOURCE 30Q, 375 ml (50 mm bed height)
 Sample: from the previous pool, diluted 1 to 3 with distilled water
 1.5 l/cycle were applied
 Buffer A: 20 mM phosphate, pH 7.4
 Buffer B: Buffer A + 1.0 sodium chloride
 Gradient: 0 to 50% B, 20 column volumes
 Flow rate: 600 cm/h

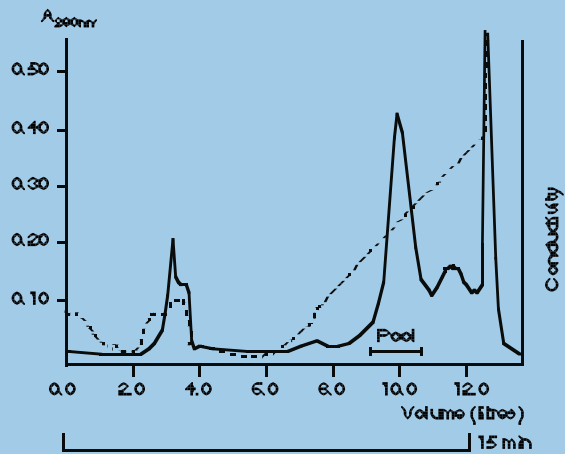

Fig. 90. Intermediate purification by ion exchange chromatography on SOURCE 30Q.

Column: 35 mm i.d.
 Medium: SOURCE 15 HPE
 Sample: from the previous step, adjusted to 1.0 M ammonium sulphate,
 0.5 l/cycle was applied
 Buffer A: 1.0 M ammonium sulphate, 50 mM phosphate, pH 7.4
 Buffer B: 50 mM phosphate
 Gradient: 0-45% B, 15 column volumes
 Flow rate: 200 cm/h

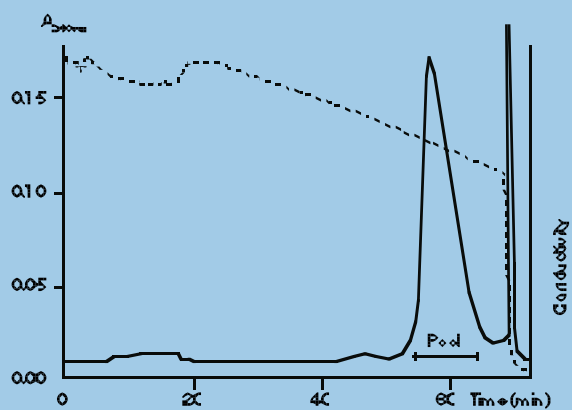

Fig. 91. Polishing by hydrophobic interaction chromatography on SOURCE 15PHE.

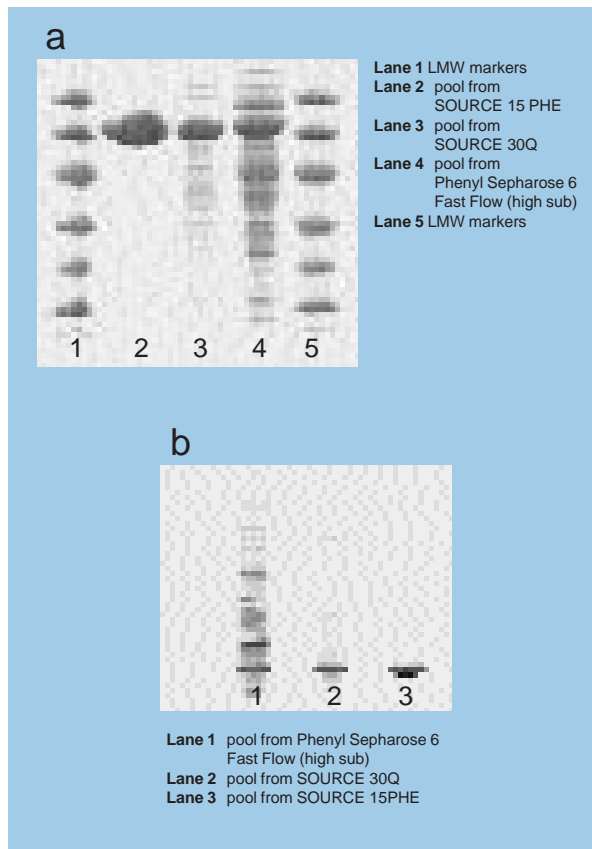

Fig. 92. a) SDS-PAGE on PhastGel Gradient 8-25
 b) Native PAGE on PhastGel Gradient 8-25

Table 24

Purification step	Volume, litre	Total protein, gram	Exotoxin A, gram*	Step recovery*
Bacterial extract	180	351	10.8	
STREAMLINE				
DEAE	13.5	140	8.54	79
Phenyl Sepharose 6				
Fast Flow (high sub)	11.4	41	6.60	77
SOURCE 30Q	30.2	12.6	6.04	91
SOURCE 15PHE	12.2	n.d.	5.5	91

* Activity was determined with a radial immunodiffusion assay using Goat anti-exotoxin A antibodies (List, USA).

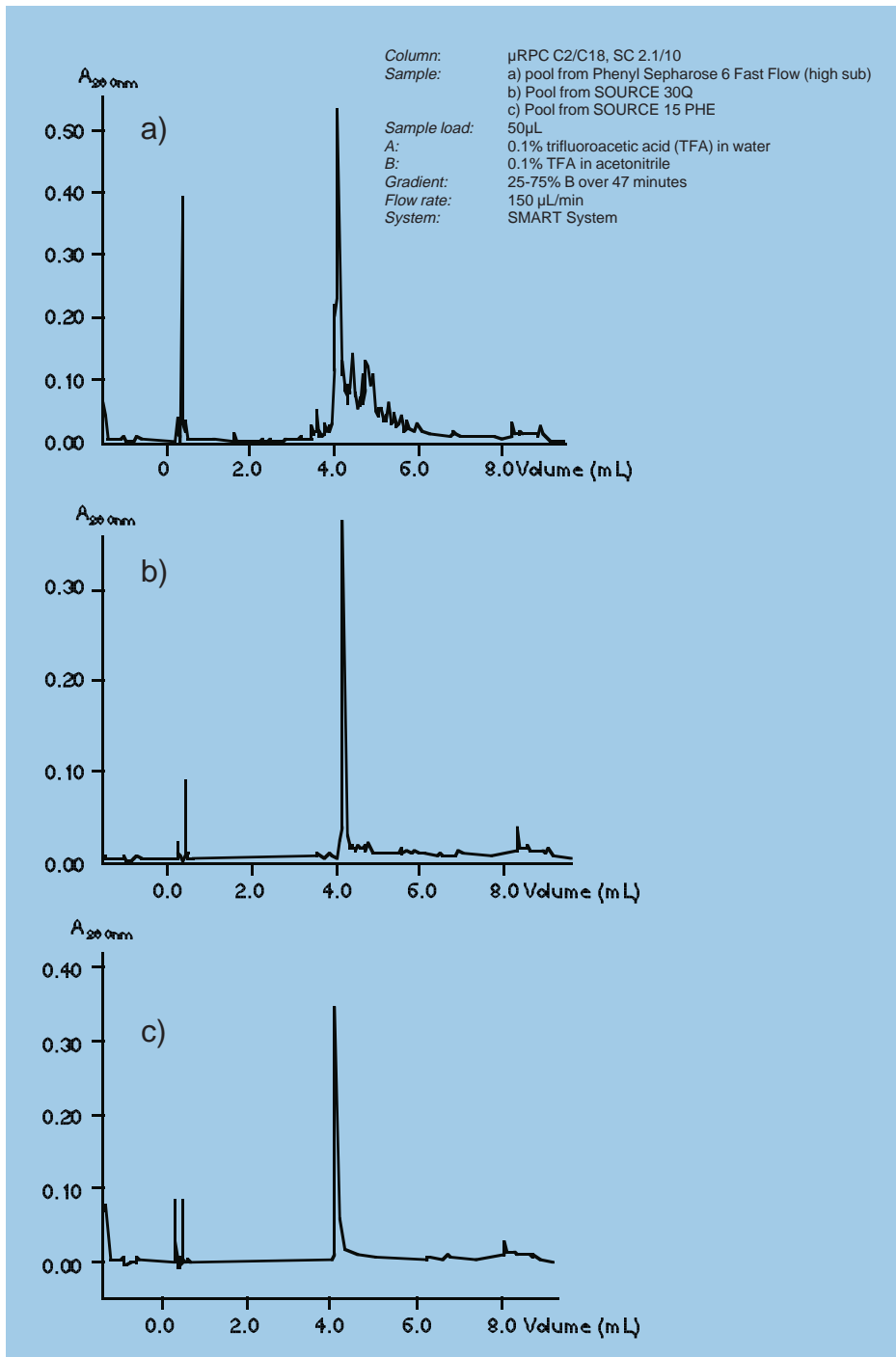

Fig. 93. Reversed phase chromatography analysis of pools obtained after the purification steps.

Strategy

The starting point for developing the purification strategy was experience from a successful downstream process for purification of another modified *Pseudomonas aeruginosa* exotoxin, LysPE38 (Fig. 94). Refinements included reducing the number of steps by the introduction of STREAMLINE DEAE for capture, and achieving high flow rates through the use of high performance SOURCE media for late intermediate purification and polishing.

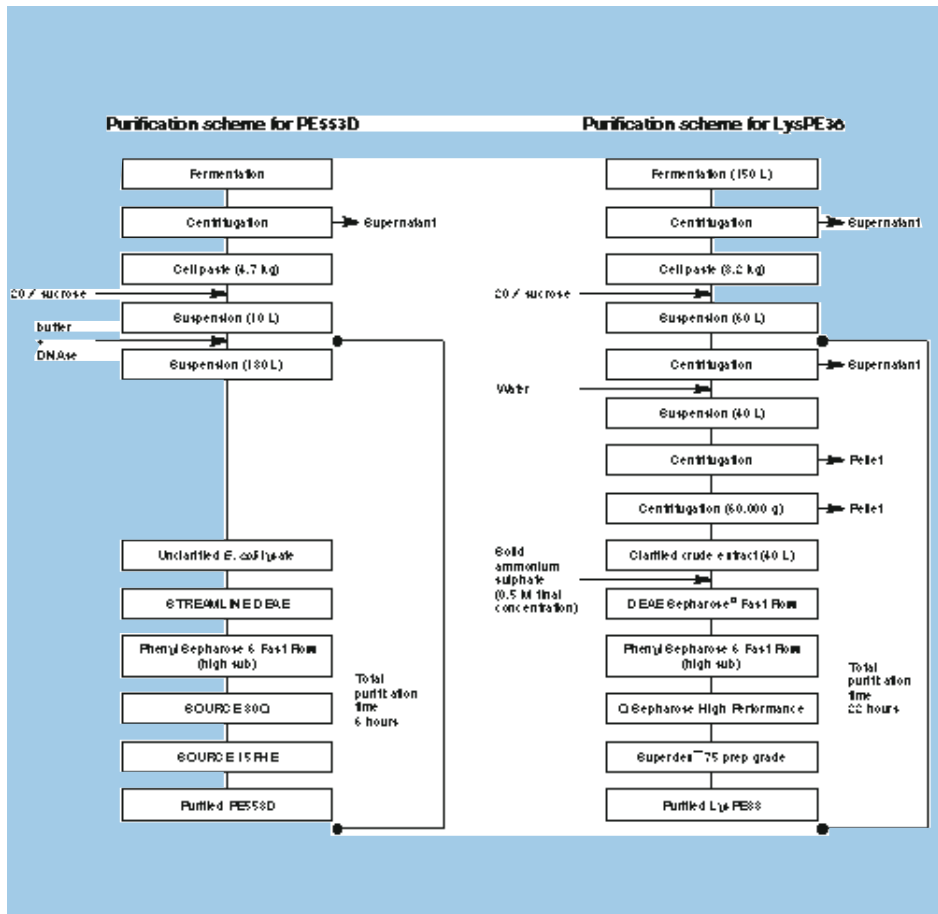

Fig. 94. Comparison of the two purification schemes.

This approach of using media designed for different stages in a downstream process speeded up process development and shortened the production schedule. Comparison with the earlier process for purification of a similar exotoxin demonstrates the dramatic savings in time achieved.

Interestingly, the use of ion exchange at more than one stage is a common characteristic of large-scale processes. Note that the role and mode of use of the ion exchanger is very different in the different stages. In the example shown, the anion exchanger, STREAMLINE DEAE, is used for expanded bed adsorption of the product from the crude, unfiltered *E. coli* lysate. STREAMLINE is optimised to handle such crude feedstocks. Particles, the bulk of the impurities and much of the water are removed in a group separation. Sample application conditions are optimised to achieve maximum selectivity during capture of the product and the stepwise elution conditions achieve maximum concentration during elution.

Later in the process, anion exchange is again used, but this time to remove proteins which have very similar characteristics to the product. This time SOURCE 30Q is used with gradient elution. The uniform, small diameter particles help to achieve good resolution with excellent flow rates and low back-pressures. The linear salt gradient further improves resolution. Note also that a different pH has been chosen to increase the binding strength of the product and further improve the resolution during elution.

In other examples ion exchange can be used repeatedly in the same process under even more divergent conditions, in one step to bind only impurities and allow the product to pass through and later to bind the product. Furthermore, anion and cation exchange can be combined in the same scheme or pH and salt gradient elution can be alternated to achieve removal of different impurities. All of this is an indication of why ion exchange is such a useful technique in industrial purification.

13. Fault finding chart

Problem	Cause	Remedy
Column is clogged.	Presence of lipoproteins or protein aggregates.	Prior to chromatography, precipitate with 10% Dextran Sulphate or 3% polyvinylpyrrolidone.
	Precipitation of proteins in the column caused by removal of stabilizing agents during fractionation.	Modify the eluent to maintain stability.
	Filter is clogged.	Replace the filter. Always filter samples and buffer before use.
	Microbial growth has occurred in the column.	Microbial growth rarely occurs in columns during use, but steps should always be taken to prevent infection of packed columns, buffers and gel suspensions. Store gel in the presence of 20% ethanol or an antimicrobial agent, see page 103.
No flow through the column	Outlet closed.	Open outlet.
	No flow from pump.	With peristaltic pumps check the condition of the tubings. Check for leaks at all connections.
	Clogged end-piece or adaptor or tubing.	Remove and clean, if possible.
Reduced or poor flow through the column.	Bed surface blocked by precipitated proteins.	Clean using recommended methods.

Problem	Cause	Remedy
Reduced or poor flow through the column.	Bed compressed.	Repacking the column may be necessary.*
	Microbial growth.	Microbial growth rarely occurs in columns during use, but steps should always be taken to prevent infection of packed columns, buffers and gel suspensions. Store gel in the presence of 20% ethanol or an antimicrobial agent, see page 103.
	Fines.	Do not use a magnetic stirrer; it can break the beads.
Back pressure increases during a run or during successive runs.	Turbid sample has been applied to the column.	Improve sample solubility by the addition of monoethylene glycol, detergents or organic solvents.
	Clogged column filter.	Prefilter buffers and samples. Change filter.
	Precipitation of protein in the column filter and/or at the top of the gel bed.	Clean the column and exchange or clean the filter. Change pH and/or add urea. Develop a procedure with detergents. Additives which were used for initial sample solubilization should be included in the solutions used for chromatography.

* Does not apply for pre-packed MonoBeads, MiniBeads, RESOURCE, HiTrap, HiLoad and BioPilot columns.

Problem	Cause	Remedy
Back-pressure increases during a run or during successive runs.	Precipitation of lipoproteins at increased ionic strength.	Lipoproteins may be precipitated prior to chromatography by the addition of 10% dextran sulphate and 1 M calcium chloride to final concentrations of 0.2% and 0.5 M respectively.
The protein does not elute in the salt gradient.	Incorrect buffer pH.	Use a buffer pH closer to the pI of the protein.
	Ionic strength too low.	Use a more concentrated limit buffer.
The protein does not elute.	Solutions have wrong pH.	Calibrate your pH meter, prepare new solutions and try again.
Protein elutes in the wash phase.	Ionic strength of start buffer is too high.	Decrease ionic strength of start buffer.
	The ionic strength of the sample is too high or the pH is wrong.	Buffer exchange on sample.
	The column is not properly equilibrated.	Repeat or prolong the equilibration step.
	Ionic detergents or other additives are adsorbed to the column.	Clean the column.
The resolution obtained is less than expected.	The gradient slope is too steep.	Use a shallower gradient or a plateau in the gradient.
	Microbial growth has occurred in the column.	See above.
	Flow rate is too high.	Run the separation at a lower flow rate.

Problem	Cause	Remedy
The resolution obtained is less than expected.	Proteins or lipids have precipitated on the column.	Clean and regenerate the column.
	Improper filtration of the sample before application to the column.	Regenerate the column, filter the sample and repeat the chromatography step.
	Aggregate formation of proteins in sample and strong binding to gel.	Use urea or zwitterions, betaine up to 10% or taurine up to 4%.
	Column is poorly packed.	Check the packing by running a coloured compound and observing the band. Repack the column if necessary.*
	Too much sample mass has been loaded onto the column.	Decrease the sample load.
	The column is dirty.	Clean and regenerate the column.
	Detector cell volume is too big.	Change the flow cell.
Leading or very rounded peaks observed in the chromatogram.	Large mixing spaces in or after column.	Reduce all post column volumes.
	Overloaded column.	Decrease the sample load and repeat the run.

* Does not apply for pre-packed MonoBeads, MiniBeads, RESOURCE, HiTrap, HiLoad and BioPilot columns.

Problem	Cause	Remedy
Leading or very rounded peaks observed in the chromatogram.	Column is poorly packed.	Check the packing by running a coloured compound and observing the band. Repack the column if necessary.*
	Column needs regeneration.	Clean and regenerate the column. If this does not help replace with a new one.
Tailing of the peak is observed in the chromatogram.	Sample too viscous.	Reduce the amount of protein.
	Precipitation of protein in the column filter and/ or at the top of the gel bed.	Remove nucleic acids. Clean the column and exchange or clean the filter.
Previous elution profile cannot be reproduced.	Incorrect buffer pH and ionic strength.	Prepare new solutions.
	The sample has altered during storage.	Prepare fresh sample.
	Proteins or lipids have precipitated on the column.	Clean and regenerate the column.
	Sample has not been filtered properly.	Regenerate the column, filter the sample carefully and repeat this step.
	Incomplete equilibration.	Equilibrate until conductivity is constant.
Previous elution profile cannot be reproduced.	Aggregate formation of proteins in sample and strong binding to gel.	Use urea or zwitterions, betaine up to 10% or taurine up to 4%.

* Does not apply for pre-packed MonoBeads, MiniBeads, RESOURCE, HiTrap, HiLoad and BioPilot columns.

Problem	Cause	Remedy
Low recovery of activity while normal recovery of protein.	Sample substance may not be stable in the elution buffers and is therefore inactivated.	Determine the pH and salt stability of the protein.
	Enzyme separated from co-factor or similar.	Test by pooling fractions and repeating the assay.
	Microbial growth.	Microbial growth rarely occurs in columns during use, but steps should always be taken to prevent infection of packed columns, buffers and gel suspensions. Store gel in the presence of 20% ethanol or an anti-microbial agent, see page 103.
Protein amount in the eluted fractions is much less than expected.	The protein may have been degraded by proteases.	Add protease inhibitors to the buffers to prevent proteolytic digestion.
	Adsorption to filter during sample preparation.	Use another type of filter or use detergents.
	Microbial growth has occurred in the column.	Microbial growth rarely occurs in columns during use, but steps should always be taken to prevent infection of packed columns, buffers and gel suspensions. Store gel in the presence of 20% ethanol or an anti-microbial agent, see page 103.
Protein amount in the eluted fractions is much less than expected.	Non-specific adsorption.	Try adding ethylene glycol (e.g. 10%) to the buffers to prevent any hydrophobic interactions.
	Sample precipitates.	May be caused by removal of salts or sample dilution.
	Hydrophobic proteins.	Chaotropic salts may be used for elution.

Problem	Cause	Remedy
More activity is recovered than was applied to the column	Different assay conditions have been used before and after the chromatographic step.	Use the same assay conditions for all the assays in your purification scheme.
	Removal of inhibitors during separation.	Replace if necessary.
Peaks too small.	Wrong sensitivity range on detector.	Adjust.
	Sample absorbs poorly at the chosen wavelength.	Use a different wavelength.
	Recorder range incorrectly set.	Adjust.
	Excessive zone broadening	Check the column packing and re-pack if necessary.
Bubbles in the bed.	Column packed or stored at cool temperature and then warmed up.	Small bubbles can often be removed by passing well de-gassed buffer upwards through the column. Column may need to be re-packed. Take special care if buffers are used after storage in a fridge or cold-room. Do not allow column to warm up due to sunshine or heating system. A water-jacket is a good safeguard. Use de-gassed buffers.
	Eluent not properly de-gassed.	De-gas the eluent thoroughly.
Cracks in the bed.	Large air leak in column.	Check all connections for leaks. Repack the column*.
Distorted bands as sample runs into the bed.	Air bubble at the top of the column or in the inlet adaptor.	Re-install the adaptor taking care to avoid air bubbles.

* Does not apply for pre-packed MonoBeads, MiniBeads, RESOURCE, HiTrap, HiLoad and BioPilot columns.

Problem	Cause	Remedy
Distorted bands as sample runs into the bed.	Particles in eluent or sample.	Filter or centrifuge the sample. Protect eluents from dust.
	Clogged or damaged net in upper adaptor.	Dismantle the adaptor, clean or replace the net. Keep particles out of samples and eluents.
Distorted bands as sample passes down the bed.	Column poorly packed.	Gel suspension too thick or too thin. Bed packed at a temperature different from run. Bed insufficiently packed (too low packing pressure, too short equilibration). Column packed at too high pressure.
Negative peaks at solvent front.	Refractive index effects.	Buffer exchange the sample to start buffer.
Strange peaks in chromatogram.	Buffer impurities.	Clean the buffer by running it through precolumn. Use high quality reagents.
Peaks on blank gradients.	Incomplete elution.	Wash the column according to recommended method.
Spikes in chromatogram.	Air bubble trapped in UV cell.	Use de-gassed solutions.
UV baseline rises with gradient.	Salt concentration, micelle formation.	Work well below or above the CMC or change the gradient so that the increase in UV absorption does not occur while the samples are eluting.
	Impurities in buffers.	Use high quality reagents.

14. Ordering information

Product	Quantity/Pack Size	Code No.
MonoBeads		
Mono Q, PC 1.6/5	1	17-0671-01
Mono Q HR 5/5	1	17-0546-01
Mono Q HR 10/10	1	17-0556-01
Mono Q HR 16/10	1	17-0506-01
Mono Q 35/100	1	17-1001-01
Mono Q 60/100	1	17-1002-01
Mono S, PC 1.6/5	1	17-0672-01
Mono S HR 5/5	1	17-0547-01
Mono S HR 10/10	1	17-0557-01
Mono S HR 16/10	1	17-0507-01
Mono S 35/100	1	17-1021-01
Mono S 60/100	1	17-1022-01
MiniBeads		
Mini Q, PC 1.6/5	1	17-0671-01
Mini S, PC 1.6/5	1	17-0671-01
Precision Column Holder	1	17-1455-01
SOURCE Q		
RESOURCE Q 1 ml	1	17-1177-01
RESOURCE Q 6 ml	1	17-1179-01
SOURCE 15Q	10 ml	17-0947-20
SOURCE 15Q	50 ml	17-0947-01
SOURCE 15Q	200 ml	17-0947-05
SOURCE 15Q	500 ml	17-0947-02
SOURCE 15Q	1 l	17-0947-03
SOURCE 30Q	10 ml	17-1275-10
SOURCE 30Q	50 ml	17-1275-01
SOURCE 30Q	200 ml	17-1275-02
SOURCE 30Q	500 ml	17-1275-03
SOURCE 30Q	1 l	17-1275-04
SOURCE S		
RESOURCE S 1 ml	1	17-1178-01
RESOURCE S 6 ml	1	17-1180-01
SOURCE 15S	10 ml	17-0944-10
SOURCE 15S	50 ml	17-0944-01
SOURCE 15S	200 ml	17-0944-05
SOURCE 15S	500 ml	17-0944-02
SOURCE 15S	1 l	17-0944-03
SOURCE 30S	10 ml	17-1273-20
SOURCE 30S	50 ml	17-1273-01
SOURCE 30S	200 ml	17-1273-02
SOURCE 30S	500 ml	17-1273-03
SOURCE 30S	1 l	17-1273-04

Product	Quantity/Pack Size	Code No.
Q Sepharose High Performance		
HiTrap Q	5 x 1 ml	17-1153-01
HiTrap Q	5 x 5 ml	17-1154-01
HiLoad 16/10 Q Sepharose HP	1	17-1064-01
HiLoad 26/10 Q Sepharose HP	1	17-1066-01
BioPilot Column Q Sepharose HP 35/100	1	17-1011-21
BioPilot Column Q Sepharose HP 60/100	1	17-1012-21
Q Sepharose High Performance	75 ml	17-1014-01
Q Sepharose High Performance	1 l	17-1014-03
Q Sepharose High Performance	5 l	17-1014-05
SP Sepharose High Performance		
HiTrap SP	5 x 1 ml	17-1151-01
HiTrap SP	5 x 5 ml	17-1152-01
HiLoad 16/10 SP Sepharose HP	1	17-1137-01
HiLoad 26/10 SP Sepharose HP	1	17-1138-01
BioPilot Column SP Sepharose HP 35/100	1	17-1031-21
BioPilot Column SP Sepharose HP 60/100	1	17-1032-21
SP Sepharose High Performance	75 ml	17-1087-01
SP Sepharose High Performance	1 l	17-1087-03
SP Sepharose High Performance	5 l	17-1087-04
Q Sepharose Fast Flow		
HiLoad 16/10 Q Sepharose Fast Flow	1	17-1060-01
HiLoad 26/10 Q Sepharose Fast Flow	1	17-1062-01
Q Sepharose Fast Flow	25 ml	17-0510-10
Q Sepharose Fast Flow	300 ml	17-0510-01
Q Sepharose Fast Flow	5 l	17-0510-04
SP Sepharose Fast Flow		
HiLoad 16/10 SP Sepharose Fast Flow	1	17-1135-01
HiLoad 26/10 SP Sepharose Fast Flow	1	17-1136-01
SP Sepharose Fast Flow	25 ml	17-0729-10
SP Sepharose Fast Flow	300 ml	17-0729-01
SP Sepharose Fast Flow	5 l	17-0729-04
DEAE Sepharose Fast Flow		
DEAE Sepharose Fast Flow	25 ml	17-0709-10
DEAE Sepharose Fast Flow	500 ml	17-0709-01
DEAE Sepharose Fast Flow	10 l	17-0709-05
DEAE Sepharose Fast Flow	60 l	17-0709-60
CM Sepharose Fast Flow		
CM Sepharose Fast Flow	25 ml	17-0719-10
CM Sepharose Fast Flow	500 ml	17-0719-01
CM Sepharose Fast Flow	10 l	17-0719-05
CM Sepharose Fast Flow	60 l	17-0719-60

Product	Quantity/Pack Size	Code No.
Sepharose Big Beads		
Q Sepharose Big Beads	1 l	17-0989-03
Q Sepharose Big Beads	10 l	17-0989-05
SP Sepharose Big Beads	1 l	17-0657-03
SP Sepharose Big Beads	10 l	17-0657-05
STREAMLINE		
STREAMLINE DEAE	300 ml	17-0994-01
STREAMLINE DEAE	7.5 l	17-0994-02
STREAMLINE SP	300 ml	17-0993-01
STREAMLINE SP	7.5 l	17-0993-02
Sepharose CL-6B		
DEAE Sepharose CL-6B	500 ml	17-0710-01
DEAE Sepharose CL-6B	10 l	17-0710-05
CM Sepharose CL-6B	500 ml	17-0720-01
CM Sepharose CL-6B	10 l	17-0720-05
Sephacel		
DEAE Sephacel	500 ml	17-0500-01
DEAE Sephacel	10 l	17-0500-05
Sephadex		
DEAE Sephadex A-25	100 g	17-0170-01
DEAE Sephadex A-25	500 g	17-0170-02
DEAE Sephadex A-25	5 kg	17-0170-03
DEAE Sephadex A-25	40 kg	17-0170-07
DEAE Sephadex A-50	100 g	17-0180-01
DEAE Sephadex A-50	500 g	17-0180-02
DEAE Sephadex A-50	5 kg	17-0180-03
DEAE Sephadex A-50	40 kg	17-0180-07
QAE Sephadex A-25	100 g	17-0190-01
QAE Sephadex A-25	500 g	17-0190-02
QAE Sephadex A-25	5 kg	17-0190-03
QAE Sephadex A-50	100 g	17-0200-01
QAE Sephadex A-50	500 g	17-0200-02
QAE Sephadex A-50	5 kg	17-0200-03
CM Sephadex C-25	100 g	17-0210-01
CM Sephadex C-25	500 g	17-0210-02
CM Sephadex C-25	5 kg	17-0210-03
CM Sephadex C-25	40 kg	on request

Product	Quantity/Pack Size	Code No.
CM Sephadex C-50	100 g	17-0220-01
CM Sephadex C-50	500 g	17-0220-02
CM Sephadex C-50	5 kg	17-0220-03
SP Sephadex C-25	100 g	17-0230-01
SP Sephadex C-25	500 g	17-0230-02
SP Sephadex C-25	5 kg	17-0230-03
SP Sephadex C-25	40 kg	on request
SP Sephadex C-50	100 g	17-0240-01
SP Sephadex C-50	500 g	17-0240-02
SP Sephadex C-50	5 kg	17-0240-03

15. References

1. The right step at the right time. *Bio/Technology*, 4, 954-958 (1986), Bonnerjera, J., Oh, S., Hoare, M., Dunhill, P.
2. Chromatography of Proteins. I. Cellulose ion exchange adsorbents. *J. Amer. Chem. Soc.* 78 (1956) 751-755, Peterson, E.A., Sober, H.A.
3. Chromatography of proteins on ion-exchange adsorbents. *Meth. Enzymol.* 22 (1971) 273—286, Himmelhoch, S.R.
4. Chromatography: a laboratory handbook of chromatographic and electrophoretic techniques. Heftman, E. (Ed.), Van Nostrand Reinhold Co., New York (1975).
5. Dynamics of chromatography, Part 1, Principles and theory. Giddings, J.C., Keller, R.A. (Eds.), Marcel Dekker Inc., New York (1965).
6. Ion exchange chromatographic characterization of stinging insect vespid venoms. *Toxicon* (Pergamon Press), 22,1 (1984) 154-160, Einarson, R., Renck, B.
7. Physicochemical considerations in the use of MonoBeads for the separation of Biological Molecules. *Protides of the Biological Fluids*, 30 (1982) 629-634, Söderberg, L. et al.
8. Gel Filtration in Theory and Practice, Pharmacia Biotech, S-75182 Uppsala, Sweden.
9. The separation of human globin chains by ion-exchange chromatography on CM Sepharose CL-6B. *Hemoglobin* 3 (1979)13—20, Sparham, S.J., Huehns, E.R.
10. Agar derivatives for chromatography, electrophoresis and gel-bound enzymes. I. Desulphated and reduced cross-linked agar and agarose in spherical bead form. *J Chromatogr.* 60(1971)161—177, Porath, J., Janson, J.-C., Laas, T.
11. Ion exchanger from pearl-shaped cellulose gel. *Nature* 223 (1969) 499—500, Determann, H., Meyer, N., Wieland, T.
12. Chromatography of mixed oligonucleotides on DEAE-Sephadex. *Biochemistry* 3 (1964) 626—629, Rushizky, G.W., Bartos, E.M., Sober, H.A.
13. DEAE-Sephadex chromatography of guanylate oligomers using guanidinium chloride. *Biochim. Biophys. Acta* 277 (1972) 290-300, Olson, A.C., Volkin, E.
14. The synthesis of triaminoacyl-insulins and the use of the t-butyloxy-carbonyl group for the reversible blocking of the amino groups of insulin. *Biochemistry* 6 (1967) 3559—3568, Levy, D., Carpenter, F.H.
15. A simple method for estimating isoelectric points. *Anal. Biochem.* 11(1965) 374—377, Lampson, G.P., Tytell, A.A.
16. Isoelectric points and molecular weights of proteins: a table. *J. Chromatogr.*127 (1976)1—28, Righetti, P.G., Caravaggio, T.
17. Isoelectric points of proteins: a table. *Anal Biochem.* 86 (1978) 620—647, Malamud, D., Drysdale, J.W.
18. Basic principles used in the selection of MonoBeads ion exchangers for the separation of biopolymers. *Protides of the Biological Fluids*, 30 (1982) 621-628, Fägerstam, L.G. et al.
19. Use of electrophoretic titration curves for predicting optimal conditions for fast ion exchange chromatography of proteins. *J. Chromatogr.* 266 (1983) 409-425, Haff, L.A., Fägerstam, L.G., Barry, A.R.

20. "Isoelectric Focusing: Principles and Methodes", Technical Booklet Series (1982), Pharmacia Biotech, Uppsala, Sweden.
21. Interrelationships of human-interferon gamma with lymphotoxin and monocyte cytotoxin. *J. Exp. Med.* 159 (1984) 824-843, Stone-Wolff, D.S., Yip, Y.K., Kelker, H.C. et al.
22. Glass wool as a potential source of artifacts in chromatography. *J. Chromatogr.* 152 (1978) 514—516, Schwartz, D.P.
23. Ion Exchange Chromatography. Protein Purification, Principles, High resolution methods and Applications, Janson, J.C., Ryden, L. (Eds) VCH, Publishers Inc. New York. (1989) 107-148, Karlsson, E., Ryden, L., Brewer, J.
24. Gel Filtration Chromatography. L. Fischer. Elsevier, Amsterdam (1980)
25. Arthropod hemocyanin structure: isolation of eight subunits in the scorpion. *Arch. Biochem. Biophys.* 193 (1979)140—149, Lamy, J., Lamy, J., Weill, J.
26. Rapid isolation of *Escherichia Coli* β -galactosidase by fast protein liquid chromatography. *J. Chromatogr.* 393 (1987) 462-465, Motorin, Y.A. et al.
27. Chromatography of proteins and peptides on Sephadex ion-exchangers: dependence of the resolution on the elution schedule. *FEBS Lett.* 14 (1971) 7—10, Novotny, J.
28. High Performance ion-exchange separation of oxidised and reduced nicotinamide adenine dinucleotides. *Anal. Biochem.* 142 (1984) 232-234, Orr, G.A., Blanchard, J.S.
29. FPLC of leukaemia cell N-Acetyl β -D-Hexosaminidases. *Leukaemia Res.*11 (1987) 437-444, Scott, C.S., Patel, M., Stark, A.N., Roberts, B.E.
30. Presented at Sixth International Congress on Methods in Protein Sequence Analysis, Seattle, Washington, USA. (1986) Bhikhabhai, R., Lindblom, H., Källman, I., Fågarstam, L.
31. Fractionation of DNA restriction fragments with ion exchangers for high performance liquid chromatography. *European Journal of Biochemistry* 155 (1986) 203-212, Müller, W.
32. Inositol triphosphates in carbochal-stimulated rat parotid glands. *Biochem. J.*, 223 (1984) 237-243, Irvine, R.F., Letcher, A.J., Lander, D.J., Downes, C.P.;
33. Inositol bis-, tris-, and tetrakis- phosphate(s): Analysis in tissue by HPLC. *Proc. Natl. Acad. Sci. USA.*, 83 (1986) 4162-4166, Meek, J.L.
34. Release of intra-cellular Ca^{2+} and elevation of inositol triphosphates by secretagogues in parietal and chief cells isolated from rabbit gastric mucosa. *Biochim. Biophys. Acta.*, 88 (1986) 116-125, Chew, C.S., Brown, M.R.
35. Albumin from human plasma: preparation and in vitro properties. in Separation of Plasma proteins. J.M. Curling, ed., Pharmacia Fine Chemicals AB, Uppsala, Sweden. (1983) 51-58. Berglöf, J.H., Eriksson, S., Suomela, H., Curling, J.M.
36. FPLC for monitoring microbial and mammalian cell cultures. *Bio/Technology* 2 (1984) 777-781, Frej, A.K. et al.
37. Varietal identification by rapid chromatography (FPLC) of wheat gliadins. 3rd Conference, Royal Australian Institute, Brisbane, Australia. (1983). Batey, I.
38. Rapid extraction and separation of plasma β -endorphin by cation exchange chromatography. *J. Chromatogr.*, 297 (1984) 399-403, Stenman, U-H., et al.
39. Applications of Fast Protein Liquid Chromatography in the separation of plasma proteins in urine and cerebrospinal fluid. *Clin. Chem.*, 29 (1983) 1635-1640, Cooper, E.H. et al.

Before any part of this handbook is reproduced, please request permission of Pharmacia Biotech. The following designations are trademarks owned by Pharmacia AB: Sephadex, Sephacel, Sepharose, STREAMLINE, HiLoad, HiTrap, MonoBeads, MiniBeads, SOURCE, RESOURCE, FPLC, FPLCdirector, UNICORN, SMART, OligoPilot II, FineLine, BPG, BioPilot, BioProcess, PhastSystem, PhastGel.

www.apbiotech.com



amersham pharmacia biotech